

KOMATSU



WA
470



Wheel Loader **WA470-7**

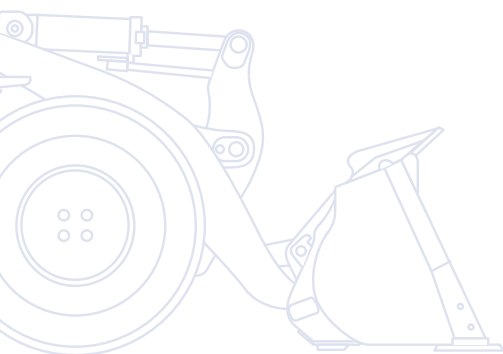

ENGINE POWER
204 kW / 273 HP @ 2.000 rpm

OPERATING WEIGHT
23.725 - 24.230 kg

BUCKET CAPACITY
4,1 - 6,0 m³

Walk-Around

The Komatsu WA470-7 wheel loader is a perfect blend of performance, comfort and fuel economy. On-board, “Komatsu SmartLoader Logic” is a new and fully automatic engine control that yields precisely enough torque for each work phase, considerably reducing fuel usage with no loss of productivity. You enjoy impressive travel speeds thanks to the new intelligent power train and the enhanced lock-up function of Komatsu’s large capacity torque converter. The WA470-7 is perfect for a great number of applications and gives extraordinary rimpull and an outstanding performance, even on steep grades or ramps. Whisper quiet, the new SpaceCab™ combines safety and ergonomics with an unprecedented level of Komatsu comfort. Reliability, ease of service, economy and safety – the WA470-7 sets new standards for the industry.



High productivity & low fuel consumption

- Low consumption EU Stage IIIB engine
- Large-capacity torque converter with standard lock-up
- Komatsu SmartLoader Logic
- More fuel-saving technology

Excellent stability and manoeuvrability

- Superior dumping height and reach
- Wide tread and long wheelbase
- Boom suspension system for minimum spillage
- Komatsu CLSS hydraulic system

WA470-7

ENGINE POWER
204 kW / 273 HP @ 2.000 rpm

OPERATING WEIGHT
23.725 - 24.230 kg

BUCKET CAPACITY
4,1 - 6,0 m³

First-class operator comfort

- Newly designed SpaceCab™
- Fully air suspended operator station
- Low noise design
- Improved operator convenience
- Rear view camera system



Simple & convenient handling

- New monitoring system
- Electronic Pilot Control (EPC) standard
- EPC-Multifunction lever (option)
- Intelligent gas pedal



Complimentary maintenance program for customers



Komatsu Wireless Monitoring System

Easy maintenance

- Wide core radiator with auto reverse fan
- Factory fitted automatic lubrication system
- Large gull-wing doors for easy access to service points
- Robust components with a long service life



High Productivity & Low Fuel Consumption

New Komatsu engine technology

The powerful and fuel-efficient Komatsu SAA6D125E-6 engine in the WA470-7 delivers 204 kW/273 HP and is EU Stage IIIB certified. Its turbo uses a hydraulic actuator to provide optimum charging pressure at all times, and makes the engine very responsive under any load conditions.

Komatsu SmartLoader Logic

The WA470-7 provides Komatsu SmartLoader Logic, a new fully automatic engine control system. Without interfering with normal operations, this technology acquires data from various sensors in the vehicle and delivers optimal engine torque for each work phase. It limits torque during less demanding operations and reduces fuel usage without decreasing production.

Komatsu Diesel Particulate Filter (KDPF)

Komatsu's high efficiency DPF captures more than 90% of particulate matter. It includes a special oxidation catalyst with fuel injection system that can incinerate trapped particulates by either active or passive regeneration with no need to interrupt machine operations.

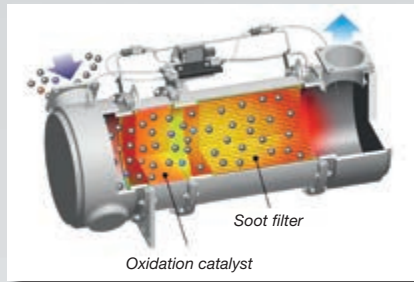

Exhaust Gas Recirculation (EGR)

Cooled EGR is a technology well-proven in current Komatsu engines. The increased capacity of the EGR cooler now ensures very low NOx emissions and a better engine performance.

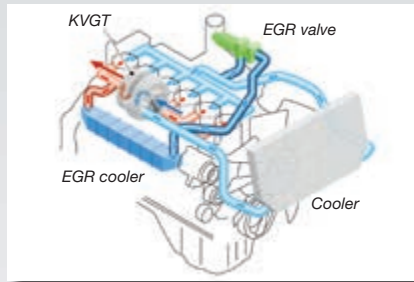

Komatsu Variable Geometry Turbo (KVGT)

The KVGT provides optimal air flow to the engine combustion chamber under all speed and load conditions. Exhaust gas is cleaner, fuel economy is improved while machine power and performance are maintained.

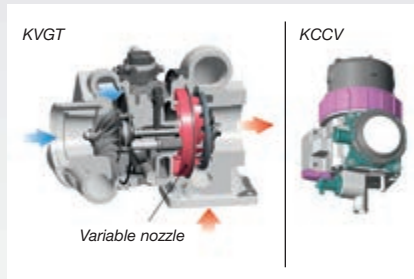

Komatsu Closed Crankcase Ventilation (KCCV)

Crankcase emissions (blow-by gas) are passed through a CCV filter. The oil mist trapped in the filter is returned back to the crankcase while the filtered gas is returned to the air intake.

High-Pressure Common Rail (HPCR)

To achieve complete fuel burn and lower exhaust emissions, the heavy duty High-Pressure Common Rail fuel injection system is computer controlled to deliver a precise quantity of pressurised fuel into the redesigned engine combustion chamber by multiple injections.

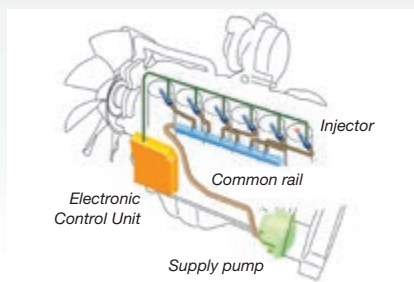

More fuel-saving technology

The selectable engine mode and adjustable idle shutdown are tools to considerably lower fuel usage. The WA470-7's Eco-Gauge displays active recommendations on the cab's monitor to help you maximise those fuel savings. For more fuel economy, the electronically controlled hydraulics pumps for the work and steering system prevent wasted hydraulic flow and deliver the exact amount of oil required for all movements of the machine.



Large-capacity torque converter with standard lock-up

With its large-capacity torque converter, the completely redesigned Komatsu drive train offers optimum efficiency and an unparalleled rimpull-to-weight ratio. By delivering high rimpull at low speeds, it makes child's play of heavy jobs like penetration of dense material such as aggregate. This means higher productivity in V-Shape loading, even in confined spaces.

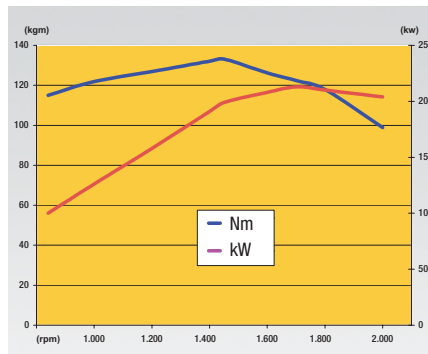

Faster Load & Carry

The sequential torque converter lock-up system delivers unbeatable productivity and fuel efficiency in Load & Carry and short distance transport applications. The operator can engage the system from 2nd to 4th gear. It noticeably increases travel speed, particularly when going uphill, thanks to the larger tractive force. It also significantly reduces fuel consumption by eliminating converter losses.

Excellent Stability and Manoeuvrability

Wide tread and long wheelbase

A 2.300 mm wide tread and a long wheel base of 3.450 mm give the WA470-7 outstanding stability – enough to handle rough terrain and fast load & carry cycles with minimum spillage and maximum comfort. With 40° steering articulation to both sides, the WA470-7 is extremely manoeuvrable in tight spaces for faster loading cycles.

Superior dumping height and reach

The long lifting frame allows an enormous dumping height of 3.010 mm and a reach of 1.315 mm that is just as impressive (with a 4,25 m³ bucket, measured to the cutting edge). With this working range, loading high feeders or trucks becomes easy and fast.

Precision control

Komatsu's CLSS hydraulics enables extremely precise control of the work equipment, and ensures that the bucket, boom and hydraulically driven attachments can all move smoothly at the same time. The WA470-7 also features variable-displacement pumps on both the hydraulic and steering systems. These pumps deliver the exact amount of oil required, dramatically improving fuel efficiency.

Boom suspension system

The boom suspension system reduces the shocks in the boom when driving with loads. Material can be transported at higher speeds with minimum spillage. When travelling below 7 km/h, the boom suspension is automatically deactivated for precise pallet loading into trucks.





Simple & Convenient Handling

New monitoring system

The WA470-7 has a brand new machine monitoring system that manages all essential functions. Specific settings can be saved in the attachment management program to speed up work in applications requiring a frequent change of buckets or other attachments.

“By Wire” operating

The Electronic Pilot Control (EPC) lever console is integrated with the seat and can be easily adjusted to suit any operator. The short levers are fingertip controlled for precise and fatigue-free operating, with a no-vibration modulating function for slowing and stopping a lowering bucket. The upper and lower boom cut-out position can be pre-set with a switch and EPC has a semiautomatic excavating function for the simple filling of buckets.

Auto-kickdown

The WA470-7 can automatically shift down from F2 to F1 to make operations easier and more productive.

Intelligent gas pedal

To reduce fuel usage, Komatsu’s innovative thrust-sensing gas pedal automatically helps you match the timing of gear shifts to the load. In heavy-duty work, requiring high rimpull and maximum acceleration, we tend to press heavily on the gas pedal. The WA470-7 anticipates this and shifts up gears as late as possible. In light-duty work, where fuel consumption is a major factor, the operator will intuitively press the gas pedal lightly. Again, the machine anticipates this – and shifts up gears as early as possible to achieve highest fuel efficiency.

EPC-Multifunction lever (option)

The EPC-multi-function lever with an integrated forward/reverse switch allows the simplest and most comfortable operation of the equipment. With one hand the driver can simultaneously control the attachment and switch between forward and reverse. The multi-function lever is the perfect choice for earth moving jobs.





First-Class Operator Comfort

Newly designed SpaceCab™

The WA470-7 cab features ample storage room with a large boot box, a storage box on the left hand side and a hot or cold box on the right. For ideal Komatsu comfort, climate control can be set to the desired temperature, and the angle of the armrest is fully adjustable. The new user friendly TFT colour monitor has a highly intuitive interface. Easily customized, with simple switches or multifunction keys and a choice of 25 languages, it gives you fingertip access to a wide range of functions and operating information to enable safe, accurate and smooth work.

Low noise design

The large cab is built on Komatsu's unique ROPS/FOPS viscous mounts. The low-noise engine, the hydraulically driven fan, and the hydraulic pumps are mounted with rubber cushions, and the sealing and noise insulation material provide a quiet, low-vibration, and dustproof environment. Ear noise levels inside the cab are reduced to just 70 db(A).

Fully air suspended operator station

The wide spacious cab features a new, fully air suspended operator control station that incorporates the side consoles mounted together with a high back, fully adjustable seat, heated (optional) for improved comfort.

Improved operator convenience

With increased in-cab storage space, an auxiliary input (MP3 jack) and 12 V and 24 V power supply, the cab offers maximum convenience. The automatic air conditioner allows the operator to easily and precisely set the cab's atmosphere.

Rear view camera

A standard fitment camera gives an exceptionally clear view of the rear work zone on the wide-screen colour monitor panel. The low profile camera is adjustable and integrated into the engine hood's shape.

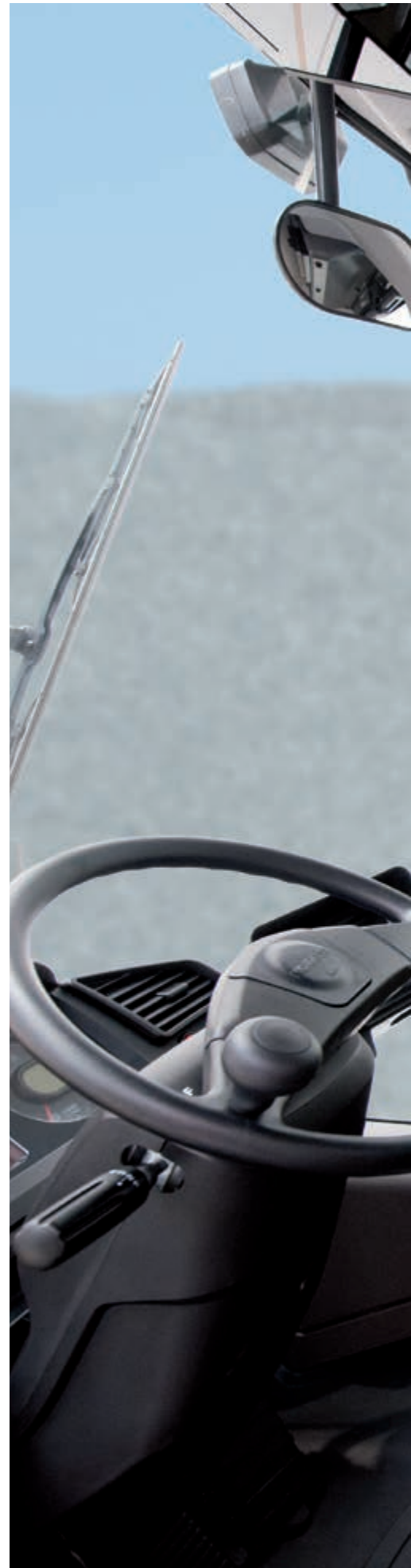

Auxiliary input (MP3 jack)



New monitoring system



Easy Maintenance



Komatsu CARE is a complimentary maintenance program for Komatsu customers that comes as standard with every new Komatsu EU Stage IIIB construction machine. For the first 3 years or 2.000 hours it covers factory-scheduled maintenance, performed by Komatsu-trained technicians with Komatsu Genuine parts. It also offers up to a maximum of 2 complimentary Komatsu Diesel Particulate Filter (KDPF) exchange units and a KDPF warranty for the first 5 years or 9.000 hours.

Easy access to service points

For easy and safe opening the gull-wing doors are supported by gas springs. The large doors give a convenient access from ground level to all daily service points. With long service intervals and all filters collected in a centralised arrangement, machine downtime is reduced to a minimum.

Wide core radiator with auto reverse fan

A wide core radiator prevents clogging even when working in a dusty environment. To minimize manual cleaning, a reversible fan blows dust out, automatically or on demand. The “automatic reverse” function allows to set the cleaning length and the time between cleaning to adjust perfectly to the working conditions.

Diesel particulate filter regeneration

No interruption or extension of daily work is required to regenerate the diesel particle filter system. Due to its superior Komatsu technology, KDPF regeneration takes place automatically, at any time.

Equipment Management Monitoring System (EMMS)

The new large high resolution monitor panel displays various machine information and allows for multiple settings. The “Operation Records” menu shows records of the average fuel consumption, idling hours, and other features. Abnormality codes are clearly displayed and stored to alert you and simplify troubleshooting. The monitor also provides for advanced monitoring of the system parameters through the Service Mode to aid in troubleshooting and reduce downtime.





Komatsu Wireless Monitoring System

The easy way to higher productivity

KOMTRAX™ is the latest in wireless monitoring technology. It delivers insightful and cost saving information about your fleet and equipment and offers you a wealth of information to facilitate peak machine performance. By creating a tightly integrated web of support it allows pro active and preventive maintenance and helps you to efficiently run a business.

Knowledge

You get quick answers to basic and critical questions about your machines – what they're doing, when they did it, where they're located, how they can be used more efficiently, and when they need to be serviced. Performance data is relayed by satellite from your machine to your computer and to your local Komatsu distributor – who's readily available for expert analysis and feedback.

Convenience

KOMTRAX™ helps to conveniently manage your fleet on the web, wherever you are. Data is analysed and packaged specifically for easy and intuitive viewing in maps, lists, graphs and charts. You can anticipate the type of service and parts your machines could require, or troubleshoot problems before Komatsu technicians arrive on site.





Power

The detailed information that KOMTRAX™ puts at your fingertips 24 hours a day, 7 days a week gives you the power to make better daily and long-term strategic decisions. You can anticipate problems, customize maintenance schedules, minimize downtime and keep your machines where they belong – working on the job site.

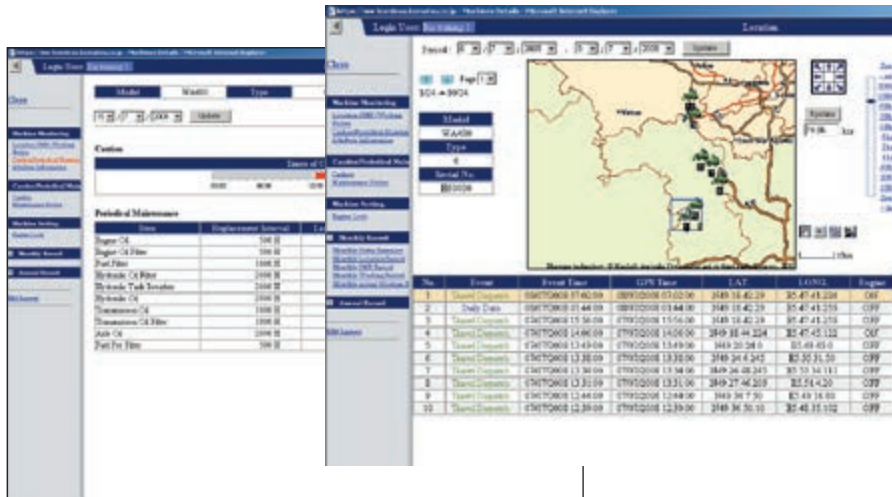

Through the web application, a variety of search parameters are available to quickly find information about specific machines based on key factors such as utilization rates, age, various notification messages, and more.

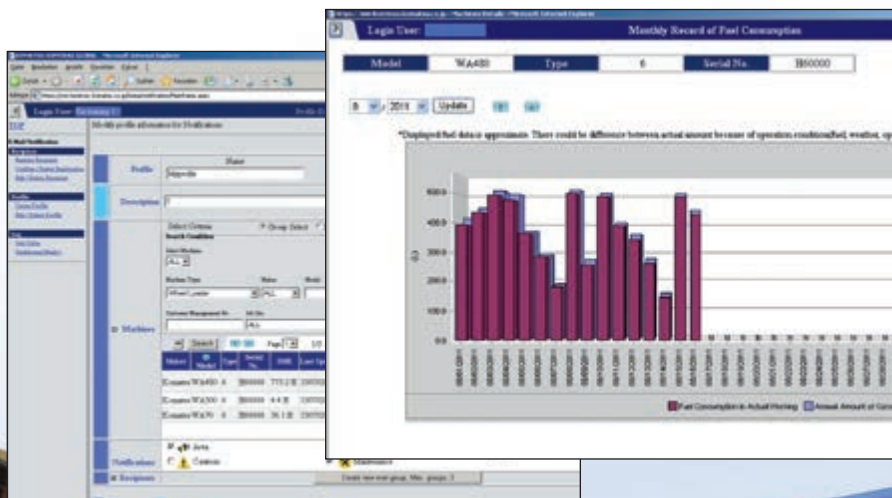

A simple chart shows the machine's fuel consumption and helps you to calculate total costs for a job site and conveniently schedule fuel deliveries.

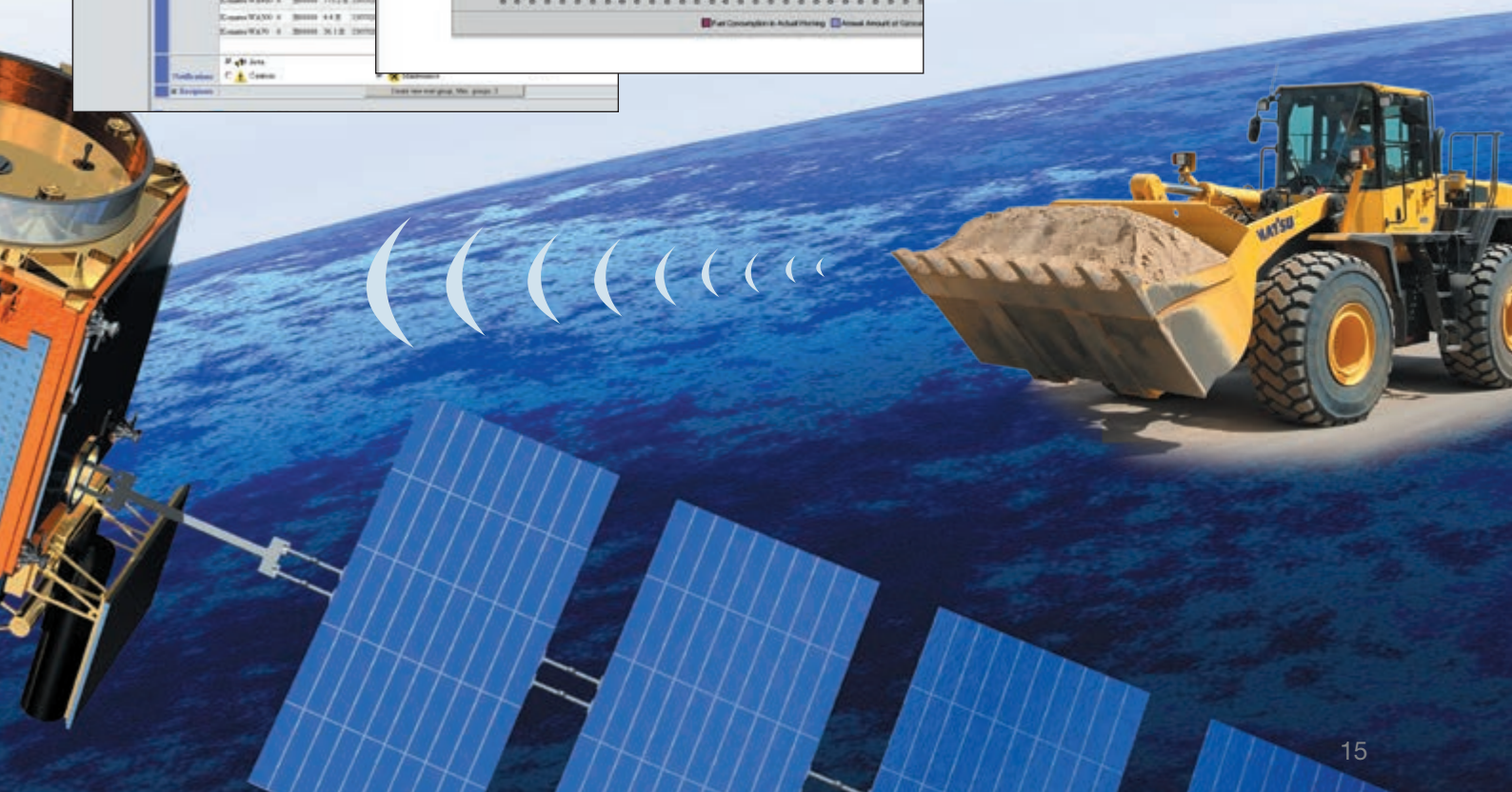

Robust and Reliable

Designed and built by Komatsu

The engine, hydraulics, power train, front and rear axles are original Komatsu components. All these components are subject to the highest quality standards right down to the smallest screw. All components are fully co-ordinated with one another, thus offering the maximum efficiency and reliability.

Heavy-duty axles

The heavy-duty axles allow exceptional service life even under the toughest working conditions. The optional limited slip differentials are most suitable for soft and slippery ground like sand or wet soil.

Wet multi-disc service brake

The multi-disc service brake is encapsulated and runs in an oil bath. The brake stays clean and operates at low temperature for increased service intervals and a long lifetime.

Robust torsion-resistant main frame

The frame design with hinge points far apart guarantees the high stability for the overall construction and reduces bearing stress in the torsional ranges.

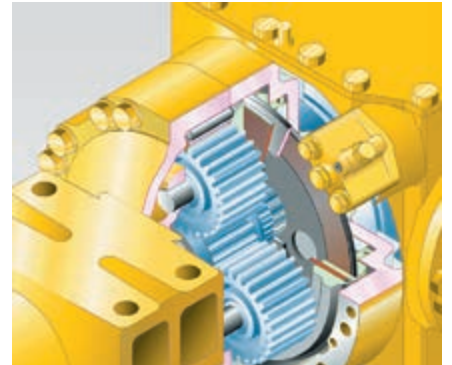



Tailored Solutions

Working gear division

Komatsu wheel loaders combined with a wide range of genuine Komatsu attachments provide the perfect solution for any industry sector. For special applications our “Working Gear” division offers purpose-built machines and attachments. The tailor made solutions allow high performance and outstanding reliability even under toughest conditions.



Waste handling

We adapt our wheel loaders to the different conditions that exist on waste handling job sites. Along with heavy duty attachments, we offer solutions to protect your machine against damage.



Timber industry

A wide range of options specifically developed for the timber industry are available: log grapples, wood chip buckets, cameras, as well as various protections and pre-filters.





Buckets and Attachments



Universal bucket

This type of bucket is impressive because of its excellent penetration and loosening properties and its good material holding properties. This universal bucket can be equipped with flush mount adapters and interchangeable teeth.



Earthmoving bucket

The earthmoving bucket with a one-piece bucket bottom is suited both for earthworks and loading cohesive material. The slanted sides give powerful penetration. It is equipped either with flush mount adapters and interchangeable teeth or also with a rear removable edge.

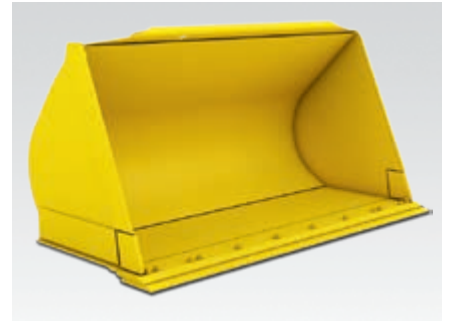

Stock pile bucket

The stock pile bucket is the right solution for handling loose and relatively light materials. The straight sidewalls ensure a high bucket capacity, the rear edge makes levelling and cleaning up jobsites easy. This stock pile bucket can be equipped with flush mount adapters and interchangeable teeth or a bolt-on cutting edge.



Heavy duty bucket

The ideal bucket for hard and abrasive conditions. Increase profits by protecting the bucket investment and reduce repair works. Komatsu offers total bucket protection by using highly wear resistant exchangeable parts. A bolt-on teeth system reduces welding on the bucket and prevents loss of teeth.



Hydraulic quick coupler

The WA470-7 can change attachments in a matter of seconds with a market compatible or HD wedge type quick coupler. With the wedge type quick coupler, featuring a unique and innovative design, the offset to the original connection points is reduced to a minimum. Thus, lifting forces remain almost the same compared to a direct mounted bucket.



A comprehensive range of attachments

The log grapple: With its sturdy structure and its great hydraulic power and a special tilting cylinder, the WA470-7 is also perfectly suited to work in the timber industry. The robust design of the lifting frame and axles ensures maximum durability.

ENGINE

Model Komatsu SAA6D125E-6
Common rail direct injection, water-cooled, emissionised, turbocharged, after-cooled diesel

Engine power
at rated engine speed 2.000 rpm
ISO 14396 204 kW / 273 HP
ISO 9249 (net engine power) 203 kW / 272 HP

Max. torque / engine speed 1.330 Nm / 1.450 rpm

No. of cylinders 6

Bore × stroke 125 × 150 mm

Displacement 11,04 ltr

Fan drive type Hydraulic

Alternator 50 A/24 V

Starter motor 7,5 kW/24 V

Filter Main-flow filter with water separator

Air-filter type Dry-air filter with automatic dust emission and preliminary purification including a dust display

TRANSMISSION

Type Automatic powershift transmission

Torque converter One-stage, two-phase, 3-element, with lock-up clutch

Speeds in km/h (with 26.5 R25 tyres)

Gear	1.	2.	3.	4.
Forward	7,6	13,2	22,7	36,2
with torque converter lock-up	–	13,5	23,6	39,0
Reverse	7,9	13,5	23,5	37,3
with torque converter lock-up	–	13,8	24,3	39,0

CHASSIS AND TYRES

System 4-wheel drive

Front axle Komatsu HD axle, semi-floating, (LSD-differential optional)

Rear axle Komatsu HD axle, semi-floating, 26° swing angle (LSD-differential optional)

Differential Spiral bevel gear pair

Final drive Planetary gear in an oil bath

Tyres 26.5 R25

SERVICE REFILL CAPACITIES

Cooling system 80 ltr

Fuel tank 380 ltr

Engine oil 68 ltr

Hydraulic system 173 ltr

Front axle 57 ltr

Rear axle 56 ltr

Torque converter and transmission 65 ltr

BRAKES

Operating brakes Hydraulically actuated, wet multi-disc brakes on all wheels

Parking brake Wet multi-disc

Emergency brake Uses the parking brake

HYDRAULIC SYSTEM

Type Komatsu CLSS (Closed Centre Load Sensing System)

Hydraulic pump Variable piston pump

Working pressure 350 kg/cm²

Maximum pump flow 260 ltr/min

No. of hydraulic/bucket cylinders 2/1

Type Double-action

Bore diameter × stroke

Boom cylinder 140 × 764 mm

Bucket cylinder 160 × 575 mm

Hydraulic cycle with rated load bucket filling

Raise time 6,1 s

Lowering time (empty) 3,1 s

Dumping time 1,6 s

STEERING SYSTEM

System Articulated frame steering

Type Completely hydraulic power steering

Steering angle to either side 40°

Steering pump Variable piston pump

Working pressure 250 kg/cm²

Pumping capacity 195 ltr/min

No. of steering cylinders 2

Type Double-action

Bore diameter × stroke 90 × 441 mm

Smallest turn (outer edge of the tyre 26.5 R25) 6.630 mm

CABIN

Two-door SpaceCab™ in conformity with ISO 3471 with ROPS (roll over protective structure) in conformity with SAE J1040c and FOPS (falling object protective structure) in conformity with ISO 3449. The air-conditioned pressurised cabin is mounted upon hydrobearings and is noise dampened.

ENVIRONMENT

Engine emissions Fully complies with EU Stage IIIB exhaust emission regulations

Noise levels

LwA external 107 dB(A) (2000/14/EC Stage II)

LpA operator ear 70 dB(A) (ISO 6396 dynamic test)

Vibration levels (EN 12096:1997)*

Hand/arm ≤ 2,5 m/s² (uncertainty K = 2,31 m/s²)

Body ≤ 0,5 m/s² (uncertainty K = 0,48 m/s²)

* for the purpose of risk assessment under directive 2002/44/EC, please refer to ISO/TR 25398:2006.

Dimensions & Performance Figures

MEASUREMENTS AND WORKING SPECIFICATIONS

Bucket type	Universal bucket				Earthmoving bucket		
		w. teeth	w. BOC	w. teeth	w. BOC	w. teeth	w. BOC
Bucket capacity (heaped, ISO 7546)	m ³	4,1	4,25	4,5	4,65	4,2	4,35
Sales code	3989	C02	C03	C12	C13	C42	C45
Material density	t/m ³	1,8	1,7	1,6	1,55	1,75	1,65
Bucket weight	kg	2.015	2.090	2.085	2.160	2.185	2.255
Static tipping load, straight	kg	19.235	19.185	19.155	19.095	19.185	19.040
Static tipping load, 40° articulated	kg	16.580	16.530	16.505	16.440	16.415	16.385
Break-out force hydraulic	kN	194	183	193	183	192	181
Lifting capability hydr. at ground level	kN	232	230	232	230	231	229
Operating weight	kg	23.825	23.880	23.910	23.975	23.810	24.035
Turning radius at corner of tyres	mm	6.990	6.990	6.990	6.990	6.990	6.990
Turning radius at bucket edge	mm	7.670	7.625	7.745	7.700	7.670	7.630
a Reach at 45°	mm	1.465	1.315	1.465	1.315	1.480	1.330
b Dumping height at 45°	mm	2.900	3.010	2.900	3.010	2.885	2.995
c Hinge pin height	mm	4.335	4.335	4.335	4.335	4.335	4.335
d Height top edge of bucket	mm	5.975	5.975	5.975	5.975	5.950	5.950
e Digging depth	mm	125	155	125	155	125	155
f Max. loading height at 45°	mm	4.025	4.025	4.025	4.025	4.020	4.020
A Overall length, bucket grounded	mm	9.090	8.930	9.090	8.930	9.140	8.950
B Wheel base	mm	3.450	3.450	3.450	3.450	3.450	3.450
C Bucket width	mm	2.995	3.000	3.165	3.170	2.990	3.000
D Width over tyres	mm	2.975	2.975	2.975	2.975	2.975	2.975
E Track width	mm	2.300	2.300	2.300	2.300	2.300	2.300
F Ground clearance	mm	505	505	505	505	505	505
H Overall height	mm	3.475	3.475	3.475	3.475	3.475	3.475

All measurements with tyres 26.5 R25 (XHA).

Details of dumping heights and reach to cutting edge or bolt-on cutting edge (BOC) or teeth

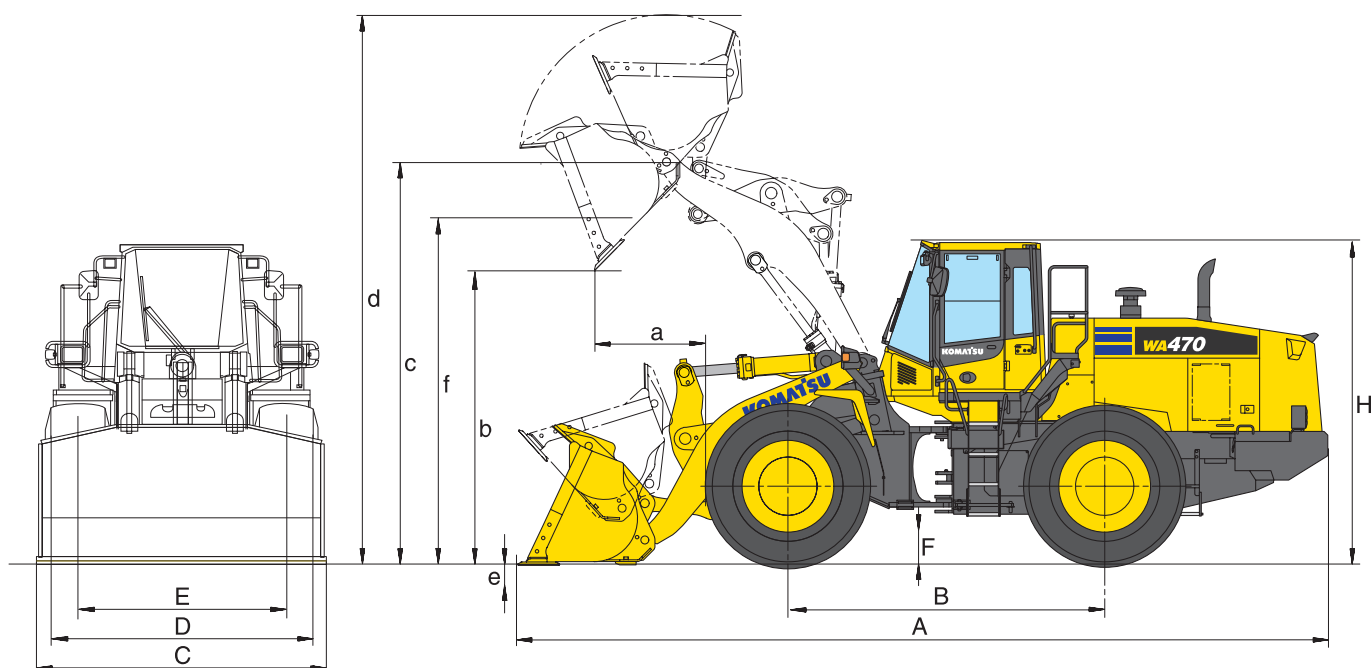



Stock pile bucket with flat bottom		Stock pile bucket with raised bottom		Heavy Duty bucket		Light material	Universal (High-lift)*
w. teeth	w. BOC	w. teeth	w. BOC	w. teeth	w. BOC	w. teeth	w. teeth
4,6	4,75	4,8	5,0	4,1	4,25	6,0	4,1
C44	C70	C16	C17	C36	C37	C21	C03
1,6	1,55	1,6	1,55	1,75	1,65	1,2	1,55
2.420	2.570	2.295	2.270	2.388	2.450	2.305	1.865
18.945	18.897	18.988	18.925	18.960	18.920	19.325	19.290
16.290	16.243	16.334	16.270	16.305	16.265	16.675	16.634
182	172	182	172	195	184	167	189
229	228	229	228	231	230	228	195
24.145	24.198	24.163	24.230	24.130	24.175	23.725	23.830
6.990	6.990	6.990	6.990	6.990	6.990	6.990	6.990
7.695	7.645	7.710	7.740	7.665	7.625	7.765	7.830
1.535	1.380	1.535	1.380	1.460	1.310	1.460	1.455
2.835	2.945	2.835	2.945	2.905	3.015	2.935	3.600
4.335	4.335	4.335	4.335	4.335	4.335	4.335	4.850
5.980	5.980	5.980	5.980	5.950	5.950	6.265	6.485
125	155	125	155	125	155	105	265
4.020	4.020	4.020	4.020	4.020	4.020	4.065	4.530
9.185	8.990	9.130	9.160	9.085	8.925	9.050	9.600
3.450	3.450	3.450	3.450	3.450	3.450	3.450	3.450
2.995	2.995	2.995	2.995	2.995	2.995	3.250	2.990
2.975	2.975	3.165	3.170	2.975	2.975	2.975	2.975
2.300	2.300	2.300	2.300	2.300	2.300	2.300	2.300
505	505	505	505	505	505	505	505
3.475	3.475	3.475	3.475	3.475	3.475	3.475	3.475

TYPICAL MATERIAL DENSITY – LOOSE (IN kg/m³)

Basalt	1.960
Bauxite, Kaolin	1.420
Earth, dry, ex store	1.510
Earth, wet, excavated	1.600
Gypsum, broken	1.810
Gypsum, crushed	1.600
Granite, broken	1.660
Limestone, broken	1.540
Limestone, crushed	1.540
Gravel, unscreened	1.930
Gravel, dry	1.510
Gravel, dry, 6-50 mm	1.690
Gravel, wet, 6-50 mm	2.020
Sand, dry, loose	1.420
Sand, damp	1.690
Sand, wet	1.840
Sand and clay, loose	1.600
Sand and gravel, dry	1.720
Sandstone	1.510
Slate	1.250
Slag, broken	1.750
Stone, crushed	1.600
Clay, natural	1.660
Clay, dry	1.480
Clay, wet	1.660
Clay and gravel, dry	1.420
Clay and gravel, wet	1.540

CHANGE IN DATA CAUSED BY:

		Add. counterweight	Heavy counterweight	StVZO counterweight	Tyres GP-4D	Tyres XMINE L5
Operating weight	kg	+385	+1.055	-670	+370	+1.125
Static tipping load, straight	kg	+984	+2.600	-1.370	+325	+840
Static tipping load, 40° articulated	kg	+820	+2.270	-1.135	+280	+760
Overall length	mm	+190	+120	0	-	-
Reach at 45°	mm	-	-	-	-15	-30
Dump height at 45°	mm	-	-	-	+15	+30
Width over tyres	mm	-	-	-	+30	+45
Overall height	mm	-	-	-	+15	+30

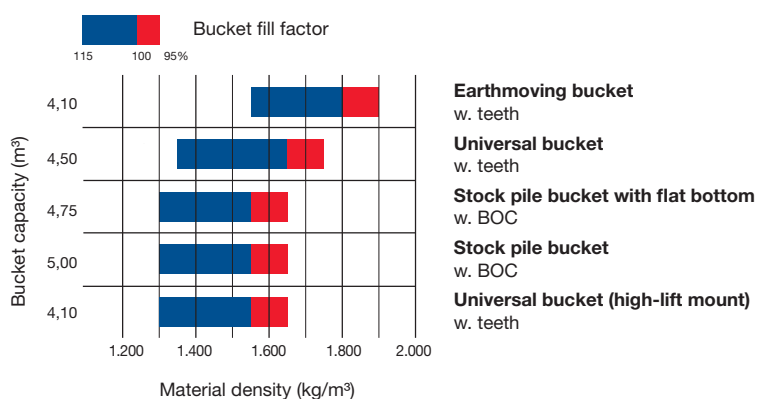

Wheel Loader

WA470-7

Standard and Optional Equipment

ENGINE

Komatsu SAA6D125E-6 turbocharged common rail direct injection diesel engine	●
EU Stage IIIB compliant	●
Komatsu SmartLoader Logic	●
Adjustable idle shutdown	●
Fuel filter with water separator	●
Batteries 2 × 180 Ah/2 × 12 V	●

CHASSIS AND TYRES

Heavy-duty axles	●
Front fenders	●
Limited-slip differential (LSD) front and rear	○
Tyres 26.5 R25 L2, L3, L5	○
Full rear fenders	○

HYDRAULIC SYSTEM

2-spool main control valve	●
EPC fingertip control, two levers, including: - Bucket stop modulation - Boom stop pre-setting - Semiautomatic dig function	●
Automatic return-to-dig	●
3-spool main control valve	○
EPC fingertip control, three levers	○
EPC 1-lever (Multi-function lever) with sliding proportional control for attachments	○
Biodegradable oil for hydraulic system	○

SERVICE AND MAINTENANCE

Hydrostat-driven radiator fan with automatic reversing function	●
Wide core radiator	●
KOMTRAX™ – Komatsu wireless monitoring system	●
Komatsu CARE	●
Tool-set	●
Automatic central lubrication	●
Filling tool for central lubrication system	○
Turbo II air pre-cleaner, cyclone type	○

CABIN

Spacious double door driver's cab to DIN/ISO	●
ROPS/FOPS frame according to SAE	●
High back air suspension seat, console mounted height adjustable arm rests	●
Retractable seat belt	●
Automatic climate control system	●
Multi-function video compatible colour monitor with Equipment Management and Monitoring System (EMMS) and efficiency guidance	●
CD radio w. auxiliary input (MP3 jack)	●
Hot and cool box	●
Heated rear window	●
Rear window wiper	●
Adjustable steering column	●
2× 12 V power supply	●
Heated, high back air suspension seat with lumbar support, console mounted height adjustable arm rests	○
3-point seat belt	○
Sun roller blind	○

TRANSMISSION AND BRAKES

Electronically controlled ECMV automatic transmission with mode selector and variable transmission cut-off	●
Working mode selection system	●
Large-capacity torque converter	●
Torque converter lock-up	●
Auto-kickdown	●

ATTACHMENTS

High-lift equipment	○
Hydraulic quick-coupler	○
Universal buckets	○
Earthmoving buckets	○
Stock pile buckets	○
High-dump buckets	○
Log grapples	○
Fork carrier and tines	○
Waste handling buckets	○
Light material buckets	○

SAFETY EQUIPMENT

Emergency steering system	●
Vandalism protection	●
Back-up alarm	●
Battery main switch	●
Handrails on left/right	●
Rear view camera system	●
Front screen protective grid	○
Shatterproof safety glass front window	○
Fire extinguisher	○
Beacon light	○
Electronic anti-theft lock	○
Electronic anti-theft lock with master key for fleet owners	○
Roof rail	○
Additional convex rear view mirror	○
Optical back-up alarm (strobe light)	○

LIGHTING SYSTEM

2 halogen main headlights	●
2 spotlights at front and rear	●
Reversing light	●
Additional lights front and rear	○
Xenon working lights	○
Step light	○

OTHER EQUIPMENT

Counterweight	●
Electronically controlled load stabilizer (ECSS II)	●
Special custom colour	○
Add. counterweight 400 kg	○
Heavy counterweight 1.085 kg	○
Anti-corrosion specification	○
Waste-handler specification	○
Cold area kit (engine and cab pre-heating)	○

Further equipment on request

The WA470-7 is equipped in accordance with the safety regulations of the machinery guidelines 89/392 EWG ff and EN474.

- standard equipment
- optional equipment

Your Komatsu partner:

KOMATSU

**Komatsu Europe
International NV**
Mechelsesteenweg 586
B-1800 VILVOORDE (BELGIUM)
Tel. +32-2-255 24 11
Fax +32-2-252 19 81
www.komatsu.eu

VENSS04401 12/2015

Materials and specifications are subject to change without notice.
KOMATSU is a trademark of Komatsu Ltd. Japan.