

PM201

Cold Planer



Cat® C18 Engine with ACERT® Technology

Gross Power	485 kW	650 hp
Rotor Width	2100 mm	83"
Rotor Depth (maximum)	305 mm	12"

Operating Weight

with conical rotor	39 165 kg	86,360 lb
with breakaway rotor	38 145 kg	84,105 lb
with weld-on rotor	38 050 kg	83,905 lb

PM201 Cold Planer

The new PM201 combines enhanced production capabilities, optimized performance and simplified service to complete tough milling applications with productive results.

C18 Engine with ACERT® Technology

ACERT® Technology works at the point of combustion to optimize engine performance and provide low exhaust emissions. The C18 engine with ACERT® Technology provides clean burning power.

Page 4

Propel System

Propel pump provides balanced flow to dual displacement drive motors on each track. Provides superior tractive effort on all surfaces. Load sensing system controlled by the ECM, matches propel speed to load on engine for maximum production.

Page 5

Rotor Drive

A Caterpillar® wet clutch with automatic belt tension adjustment delivers efficient and reliable power to the pavement. The rotor drive consists of field-proven Cat® D8 Track-type Tractor components for Caterpillar machine commonality and long service life.

Page 5



Rotor Options

With a choice of three rotor options, the PM201 can be configured for different applications and production requirements.

Page 6

Operator's Station

Ergonomic design emphasizes comfort, visibility and easy operation. Left and right side machine controls are grouped and conveniently located to enhance operator visibility, productivity and reduce fatigue.

Page 8

Maneuverability

Four steering modes: front, rear, crab and coordinated enable the operator to have complete control of the machine position in tight milling applications. The four-track drive provides productive operation.

Page 9

Front Loading Conveyor

The PM201 features a front loading conveyor for greater productivity. The conveyor swings 45 degrees to the left or right to meet your job requirements. Conveyor functions can be controlled from the operator's station or at ground level. Conveyor features a boost function to cast material farther for loading long haul trucks.

Page 7

Automatic Grade and Slope Controls

The optional grade and slope system provides precise control of the machine to a preset cutting depth and cross slope. Remote mounted control boxes allow simple operation from either the operator's station or ground level.

Page 9

Serviceability

The power-assisted engine hood opens wide and provides exceptional walk-in access to the engine, hydraulic pumps and daily service points. Hydraulic rotor service door provides convenient access to the rotor for easy cutting tool removal and replacement. Water spray nozzles are easily removed for inspection and replacement without the need for tools.

Page 10



C18 Engine with ACERT® Technology

A combination of innovations working at the point of combustion, ACERT® Technology optimizes engine performance while meeting U.S. EPA Tier 3 and European EU Stage IIIa emission regulations for off-road applications.



Optimum Power

The C18 engine performs at a full-rated gross power of 485 kW (650 hp) at 2100 rpm. The combination of large displacement and high torque allow the PM201 to achieve maximum production. Engine power curve is optimized for milling applications providing optimum power while keeping the engine operating at peak efficiency.

Mechanically-Actuated Electronically Controlled Unit Injection (MEUI)

The MEUI fuel system is a unique system that combines the technical advancement of an electronic control system with the simplicity of direct mechanically controlled unit fuel injection. The MEUI system excels in its ability to control injection pressure over the entire engine operating speed range. These features allow the C18 to have complete control over injection timing, duration and pressure.

Precise Multiple Injection Fuel Delivery

Combustion chamber temperatures are lowered by precisely shaping the combustion cycle generating fewer emissions and optimizing fuel combustion; translating into more work output for your fuel cost.

C18 Cylinder Block

The cylinder block is a one-piece, grey iron block that features generous ribbing for stiffness and heavy bearing bulkheads for rigidity and strength as the crankshaft turns. This new design supports the engine's higher compression ratios and increases its power density. The incorporation of straight-thread, o-ring connection points reduces the loss of engine oil and fluids.

High Cylinder Pressures

High cylinder pressures combined with tightly controlled tolerances promote extremely efficient fuel burn, less blow by and lower emissions.

Service, Maintenance and Repair

Easier service, maintenance and repair is accomplished by monitoring key functions and logging critical indicators. Advanced electronic diagnostic capabilities are possible using Cat Electronic Technician.

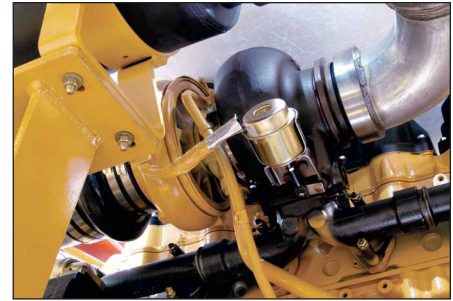

Turbocharged and Air-to-Air Aftercooling (ATAAC)

High horsepower with increased response time is assured while keeping exhaust temperatures low for long hours of continuous operation.

Air-to-Air Aftercooling

Air-to-air aftercooling keeps air intake temperatures down and in concert with the tight tolerance combustion chamber components, maximizes fuel efficiency and minimizes emissions. New turbocharger, unique cross-flow head design, single front driven overhead cam and a more efficient intake manifold generate significant improvements in air flow, maximizing efficiency and reduced emissions.

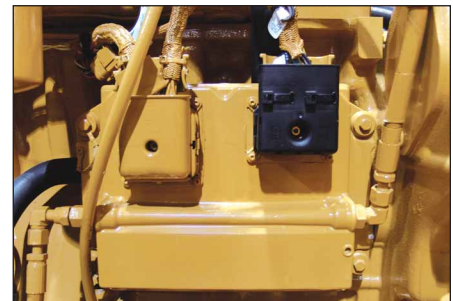

ADEM™ A4 Electronic Control Module

The module manages fuel delivery, valve timing and airflow to get the most performance per liter (gallon) of fuel used. The control module provides flexible fuel mapping, allowing the engine to respond quickly to varying application needs. It keeps track of engine and machine conditions while keeping the engine operating at peak efficiency.

Propel System

Hydrostatic drive with hydraulic flow provided by a variable displacement piston-type pump. Drive motors on each track provides balanced tractive effort.

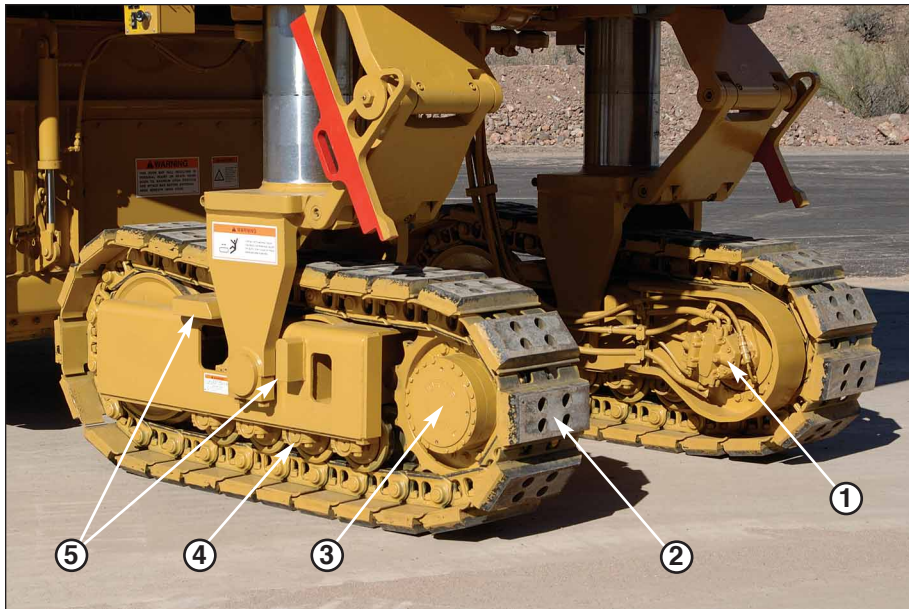

- 1 Two Speed Drive Motor
- 2 Polyurethane Track Pads
- 3 Planetary w/Secondary Brake
- 4 Heavy-duty Cat Rollers
- 5 Track Frame Stops

Propel pump provides balanced flow to the dual displacement drive motors on each track. Provides superior tractive effort on all surfaces.

Load sensing system controlled by the ECM, matches propel speed to load on engine for maximum production.

Two speed ranges allow the machine to operate at either maximum torque to propel the machine through the toughest materials or a greater speed for moving around the job site.

Infinitely variable machine speeds determined by the propel lever.

Positive traction control provides equal hydraulic oil flow to each drive motor to increase tractive effort in hard cutting applications.

Polyurethane track pads provide long service life and positive traction on all pavement surfaces.

Rotor Drive

Caterpillar® wet clutch delivers maximum available horsepower to each ground engaging tool while providing long service life and reliability.

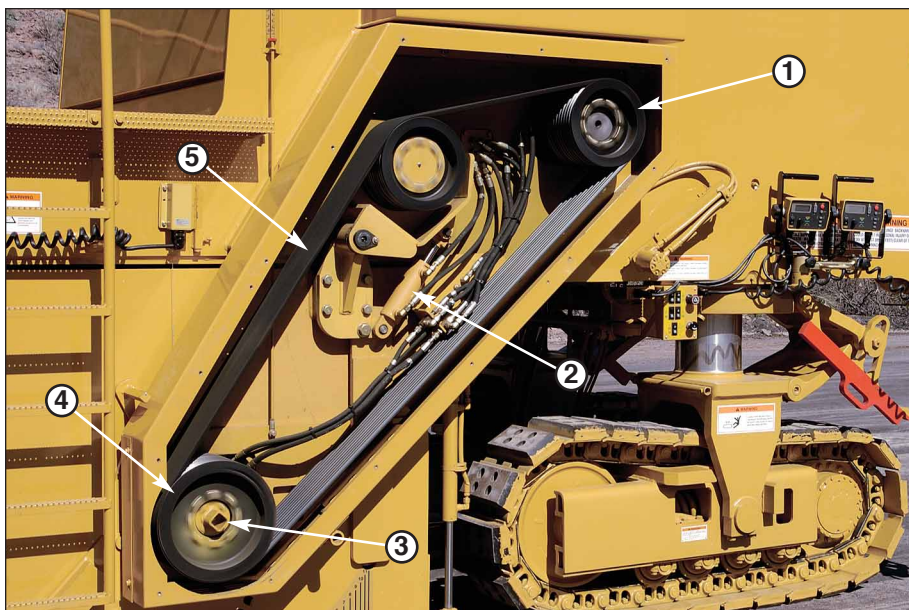

- 1 Upper Sheave
- 2 Tension Cylinder
- 3 Input Shear Shaft
- 4 Lower Sheave
- 5 Molded Drive Belt

Caterpillar® wet clutch is the most efficient and reliable system of applying rotor power to the pavement. The rotor clutch system has a separate oil sump, pump, filter, clutch control valve and oil cooler to provide continuous cooling and lubrication.

Upper and lower sheave bearings are continuously lubricated with oil from the rotor drive clutch sump to provide long life and reduced maintenance.

Caterpillar drum drive gear reducer provides reliability and long service life. An input shear shaft is provided to protect the rotor and final drive from overload conditions. Rotor mandrel is liquid-filled to dissipate heat and cools gear reducer.

Molded eleven-rib high tensile belt provides long service life.

Automatic belt tension adjustment prevents slipping and reduces maintenance.

Rotor Selection

Choice of three rotor designs for different applications and production requirements. Tools are mounted in drive-in, knock-out holders for quick and easy replacement.

Conical Tool Holder Rotor

190 point-attack carbide-tipped tools are mounted in durable three-piece, patented quick release tool holders and arranged in a triple-wrap configuration for maximum breakout force.

Quick release conical tool holder features a tapered fit maintaining tightness in holder base.

Large replaceable carbide-faced loading paddles effectively moves milled material onto collecting conveyor resulting in higher production and less wear on inside of rotor chamber and cutting tools.

Triple-tree tool placement on rotor ends provides optimum tool spacing to clean up loose material and reduces wear on drum when maneuvering in the cut.

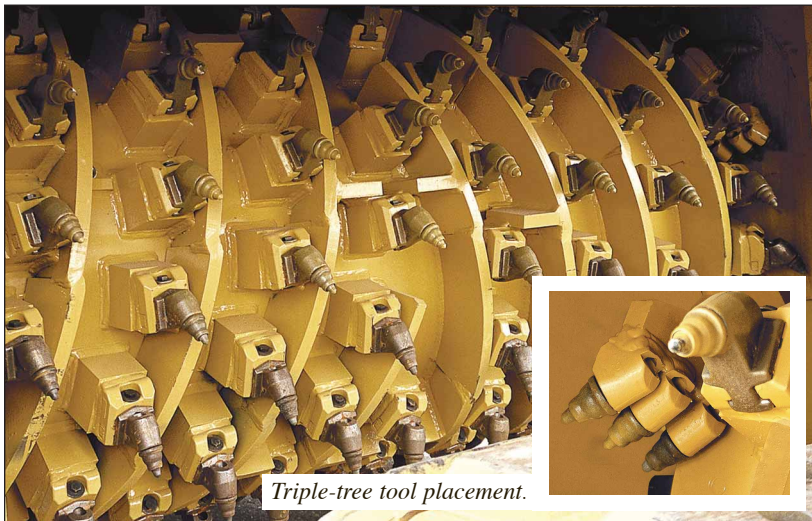
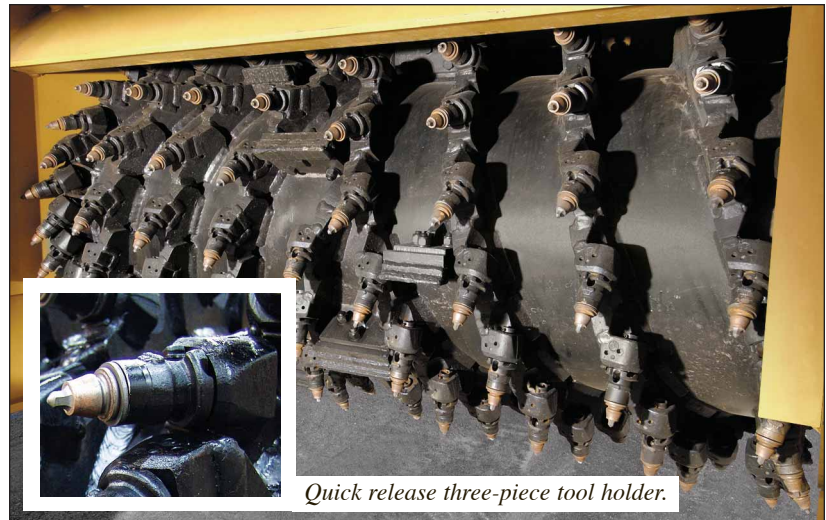

Breakaway Tool Holder Rotor

170 point-attack carbide-tipped tools are mounted in drive-in, knock-out tool holders and arranged in a triple-wrap configuration for maximum breakout force.

Bolt-on breakaway design tool holders allow for fast replacement without welding.

Triple-wrap design provides optimum tool impact spacing for high production.

Segmented lighting is designed to help protect base blocks and effectively move milled material onto collecting conveyor.

Triple-tree tool placement on rotor ends provides optimum tool spacing to clean up loose material and reduces wear on drum when maneuvering in the cut.

Weld-on Tool Holder Rotor

147 point-attack carbide-tipped tools are mounted in drive-in, knock-out tool holders and arranged in a triple-wrap configuration for maximum breakout force.

Triple-wrap design provides optimum tool impact spacing allows higher working speeds and high production.

One-piece lighting has a thickness of 51 mm (2") to provide optimum material movement onto collecting conveyor and minimum wear.

Large loading paddles welded to the drum helps move material onto the collecting conveyor.

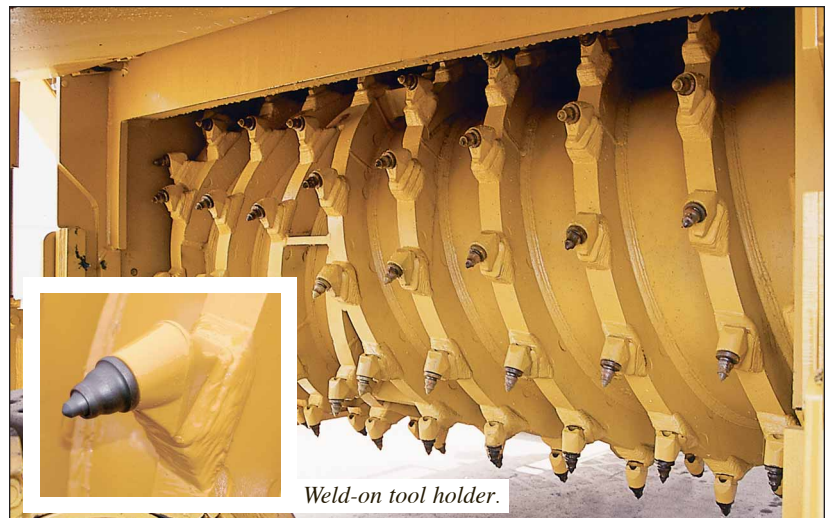

Primary Collecting Conveyor

A large discharge opening and wide collecting conveyor belt clears out the cutter box fast for increased production. Water spray system provides lubrication and controls dust.

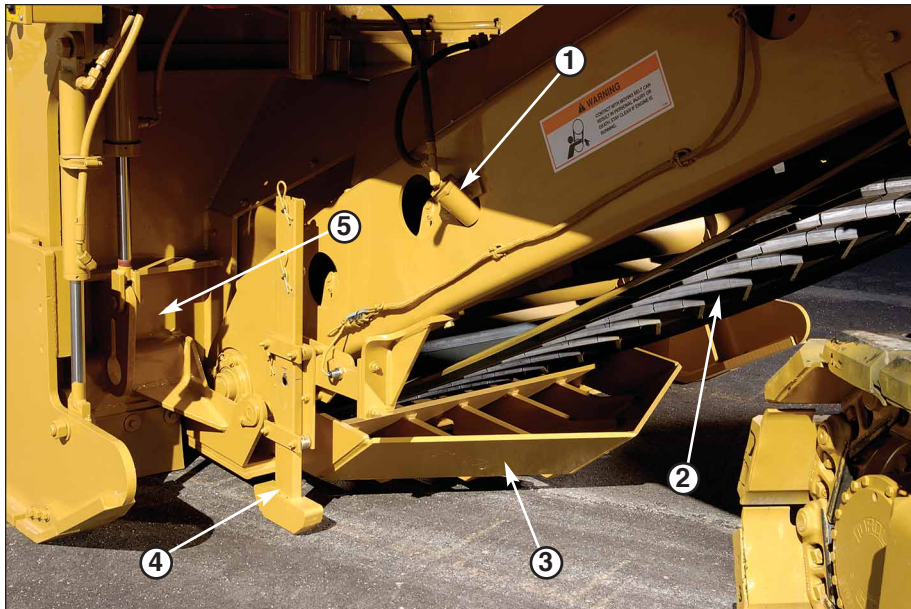

- 1 Water Spray Nozzles
- 2 Seamless Belt
- 3 Anti-Slab Device
- 4 Anti-Kickback Device
- 5 Hydraulic Front Door

Large discharge opening clears out the cutter box fast for increased production.

1020 mm (40") wide collecting conveyor is driven by two high torque hydraulic motors provides maximum efficiency.

Seamless belt features 25 mm (1") high cleats to clear out the cutter box effectively and provides better control of fine particles.

Standard water spray lubricates and controls dust on collecting belt. Water spray nozzles are easily removed for inspection and replacement without the need for tools.

The optional hydraulically operated front door provides an adjustable down pressure to prevent slabbing of the road surface resulting in optimum sizing and gradation.

Anti-kickback device automatically deactivates the rotor drive and propel systems if a kickback is detected.

Front Loading Conveyor

High capacity and versatility adds to productivity. Momentary boost function increases material handling to load long tractor trailers from the rear.



915 mm (36") wide upper conveyor with hydraulically controlled height adjustment and two cylinders for a 45 degree swing to the left and right.

Seamless belt features 25 mm (1") high cleats, offers long service life and provides better control of fine particles.

Variable belt speed controls upper belt loading to match milled material type and amount.

Conveyor boost function increases material handling to load long tractor trailers from the rear.

Conveyor raise, lower and swing controlled from the operator's station and at two ground level control stations.

Operator's Station

Designed for efficiency, productivity and simple operation from either side of the console. Easy to reach controls minimize operator fatigue.

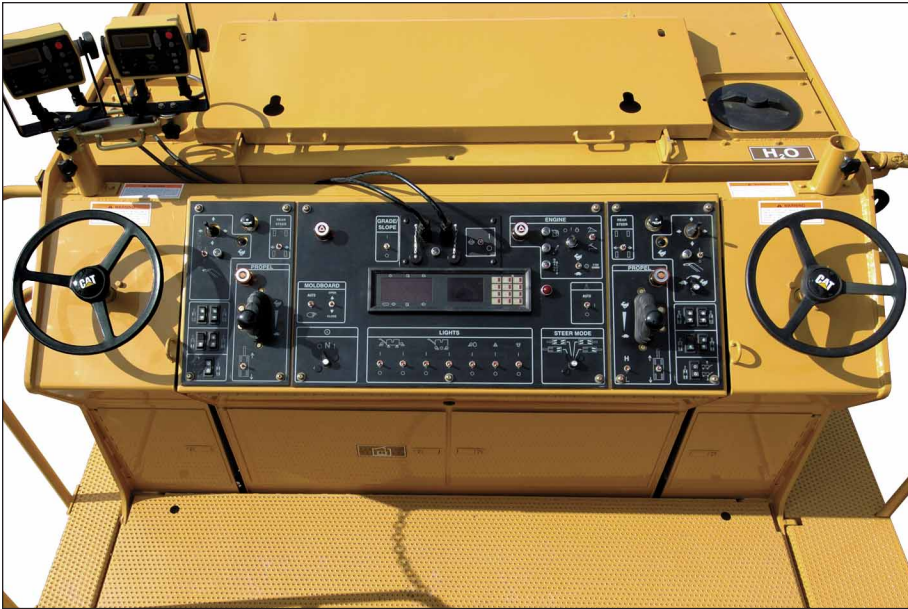

Dual operating controls including steering wheels, propel levers, upper conveyor, machine elevation and rear track steering functions.

Computerized Monitoring System (CMS) constantly monitors system pressures and engine condition with six modes of operation. Alerts the operator if a problem does occur with three levels of warning.

Clear control and instrumentation layout designed for ease of use. All gauges and displays are easily visible in direct sunlight or low light conditions.

Isolated platform with four heavy-duty rubber mounts to reduce machine vibration transmitted to the operator.

Low sound levels help the operator and ground crew communicate effectively.

Warning horns and shut down buttons located on the operator's station and at five ground level control stations.

Electronic Control Module

Reliable Caterpillar® technology that makes machine operation simple and self-diagnostics simplifies troubleshooting.

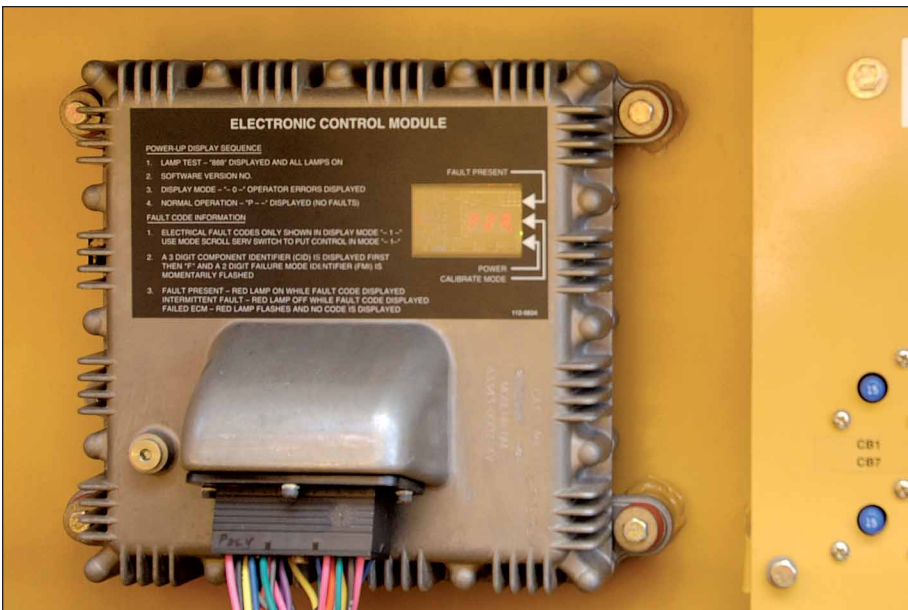

Reliable Caterpillar® technology achieves maximum productivity and simplifies troubleshooting.

Electronic Control Module (ECM) receives input signals from sensors in the engine, propel, steering and rotor drive systems which monitor current operating conditions.

Self-diagnostics provides information for troubleshooting and alerts the operator of potential system problems.

Automatic load control adjusts propel speed so that engine speed is maintained at no less than 1900 rpm. Machine always works at peak efficiency for maximum production.

Steering control provides four steering modes for maneuvering in tight quarters: front steer only, crab steer, coordinated steer and rear steer only.

Automatic Grade and Slope Control

The optional contacting or non-contacting grade controls provide precise control of the machine to a preset cutting depth. System can be configured to control grade or cross slope.

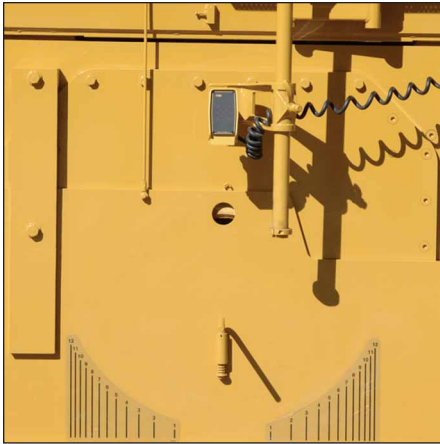

Non-contacting grade sensor.



Contacting grade sensor.



Remote mounted control boxes.

Contact or non-contact grade sensors can be positioned on each side are easy to position and provides a consistent accuracy to ± 3 mm (1/8"). Cross slope sensor adds to system versatility.

Contacting wire rope grade sensor measures side plate movement that enables the entire length of the side plate to become an averaging device for extremely accurate grade matching.

Remote mounted control boxes allow manual or automatic operation from either the operator's station or at ground level. Constant read-out for rotor depth and cross slope are easily visible in direct sunlight or low light conditions.

Sonic Averaging System features three non-contacting grade sensors or a combination of one contacting and two non-contacting sensors that mount on the side of the machine. Enables the entire length of the machine to become an averaging device.

Maneuverability

Four steering modes provide excellent handling for precise control and production.



Steering control provides four steering modes for maneuvering in tight quarters: front steer only, crab steer, coordinated steer and rear steer only.

Standard reinforced polyurethane track pads provides good traction, added stability and improved durability against track pad separation.

Visibility to the cutter box side plates is exceptional. Excellent visibility increases productivity and allows the operator to precisely place the rotor against gutter pans or when working near obstructions.

Dual propel levers provide infinitely variable machine speeds for moving around the job site quickly.

Reliability and Serviceability

Reliability and serviceability are integrated into every Caterpillar machine. These important features keep your machine investment profitable.

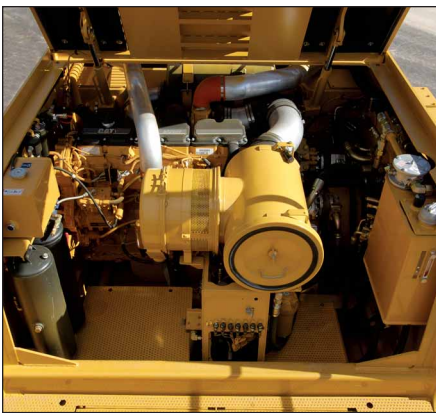

The power-assist engine hood opens wide to provide walk-in access to the engine, air filter, hydraulic components and daily service points.

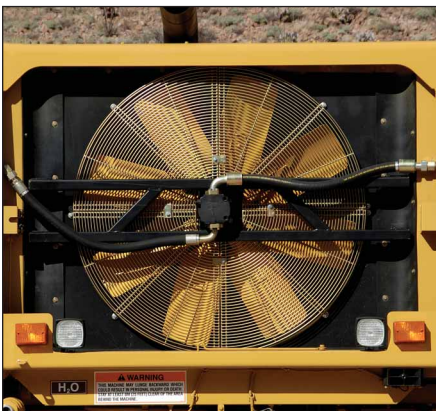

Electronically controlled on-demand variable speed cooling fan provides the lowest overall noise levels and high ambient operation capability.

Hydraulic rotor service door opens wide for convenient access to rotor for inspection and tool maintenance.

Engine mounted air compressor and cutting bit removal tools makes changing cutting tools quick and easy.

Chrome leg cylinders slide through leg barrel equipped with a lip seal and a replaceable nylon sleeve-type bearing.

Electronic Control Module (ECM) monitors machine systems and provides self-diagnostics for operator or service personnel.

Three warning levels alert operator to conditions on the machine that require attention. Encourages repair before major failure.

Level One – a flashing gauge indicator and a flashing alert indicator light.

Level Two – level one warning plus the warning action lamp flashing.

Level Three – level two warning plus the warning action horn sounds.

Visual indicators allow easy check of radiator coolant, water spray tank level, hydraulic oil tank level and air restriction indicator.

Quick-connect hydraulic test ports simplify system diagnostics.

Ecology drains provide an environmental method to drain fluids. They are included on the radiator, engine oil pan and hydraulic tank.

S•O•SSM ports allow for simple fluid collection of engine oil, engine coolant and hydraulic oil.

Secure hose routing with polyethylene routing blocks to reduce rubbing and increase service life.

Nylon braided wrap and all-weather connectors ensure electrical system integrity. Electrical wiring is color-coded, numbered and labeled with component identifiers to simplify troubleshooting.

Maintenance-free Caterpillar batteries are mounted on the top of the machine and are accessible through a bolt-on cover. Cat batteries are specifically designed for maximum cranking power and protection against vibration.

Cooling package is a multi-row modular design, stacked in series for easy access for cleaning and service. A modular stacked cooling system provides more efficient cooling of individual systems and makes replacement and routine cleaning easier.

Engine

The Caterpillar® C18 engine with ACERT® Technology is a six cylinder, turbocharged air-to-air after-cooled diesel engine. The engine meets U.S. EPA Tier 3 and European EU Stage IIIa engine emission regulations.

Engine	Cat® C18	
	kW	hp
Gross Power		
	485	650
SAE J1995	483	648
Net Power		
ISO 9249	466	625
EEC 80/1269	466	625
SAE J1349	461	618

Specifications

Bore	145 mm	5.7"
Stroke	183 mm	7.2"
Displacement	18.1 liters	1105 in ³

- The power ratings apply at a rated speed of 2100 RPM when tested under the reference conditions for the specific standard.
- The net power advertised is the power available at the flywheel when the engine is equipped with an alternator, air cleaner, muffler and fan at minimum speed.
- The net power at the flywheel when the fan is at maximum speed is 445 kW (597 hp) per the SAE J1349 reference standards.
- Derating is not required up to an altitude of 2134 m (7000').
- Dual fuel filters with water separator and air compressor are standard.

Rotor Options

Three rotor styles are available. All mount to the standard rotor chamber.

Rotor	Width	Diameter	Tools	Max. Depth
Conical	2100 mm (83")	1168 mm (46")	190	305 mm (12")
Breakaway	2100 mm (83")	1168 mm (46")	170	305 mm (12")
Weld-on	2100 mm (83")	1168 mm (46")	147	305 mm (12")

Propel System

Hydrostatic drive with hydraulic flow provided by a variable displacement piston-type pump. Drive motors with planetary gear reduction on each track provides balanced tractive effort.

Features

- A variable displacement, piston-type pump with electronic displacement control supplies pressurized flow.
- Positive traction control valve provides equal hydraulic oil flow to each drive motor to increase tractive effort in hard or deep cuts. Operator can activate by a switch on the operator's console.
- Drive motors have two swashplate positions allowing operation at either maximum torque for work or greater speed for moving around the job site.
- Gear selection controlled electrically by a two-position switch on the operator's console.
- Infinitely variable machine speed and direction of travel controlled by propel lever.
- Load sensing system, controlled by Electronic Control Module (ECM), matches propel speed to load on the engine.
- Tracks are 2045 mm (80.5") long, 348 mm (14") wide and feature replaceable, steel reinforced polyurethane track pads for long life.

Max. Speeds (forward and reverse):

Operating	40 mpm - 132 fpm
Travel	6.0 km/h - 3.7 mph

Rotor Drive System

Operates direct through a hydraulically actuated, Caterpillar wet clutch driving a Caterpillar planetary gear reducer located inside the rotor mandrel.

Features

- Heavy-duty wet clutch mounts directly to the engine. Hydraulically actuated by a ON/OFF switch on the operator's console.
- The rotor clutch system has a separate oil sump, pump, filter, clutch control valve and oil cooler to provide continuous cooling and lubrication.
- Upper and lower sheave bearings are continuously lubricated with oil from the clutch sump to provide long life.
- One eleven-rib high tensile strength drive belt drives the rotor through a drum drive gear reducer located inside the rotor mandrel.
- The Caterpillar D8 Track-type-Tractor drum drive gear reducer provides reliability and long service life.
- The rotor mandrel is partially liquid-filled to dissipate heat and cools the drum drive gear reducer.
- Input shear shaft protects rotor drive components from severe shock loads.
- Hydraulically powered automatic drive belt tensioner prevents slipping and reduces maintenance.
- Single caliper with dual disc brake installed on PTO output drive shaft.

Rotor Speed:

@ 2100 engine rpm	98 rpm
-------------------	--------

Rotor Housing

- Large discharge opening clears out the rotor housing fast for increased production and reduced tool wear.
- Side plates have replaceable bolt-on carbide wear strips front and rear and features wear-resistant skis for reduced wear and longer service life.
- Floating moldboard with adjustable down pressure is standard and features a carbide replaceable cutting edge.
- A panel on the rear door can be removed to windrow the milled material directly behind the machine.
- Height control for rotor door located at operator's station and at two ground level control stations.

Steering

Hydraulic power-assist steering with two steering wheels on operator's console. Four steering modes with automatic realignment of rear tracks through ECM is standard.

Features

- Double-acting steering cylinders control the front and rear tracks and are powered by a pressure-compensated, piston-type pump. Constant pressure is assured in the steering system.
- Switch on operator's console provides four steering modes.

Steering Modes

- Front steer only—controlled by a hand metering unit, maintained by closed-loop control. The ECM automatically aligns rear tracks to the center position for straight tracking.
- Rear steer—controlled by a toggle switch on operator's console, maintained by closed-loop control.
- Crab—front and rear tracks turn simultaneously in the same direction.
- Coordinated—front and rear tracks turn simultaneously in the opposite direction.

Turning Radius:

Minimum 4.66 m (15' 4")

Dimensions

Operating

A Overall length (conveyor up)	15.1 m	49' 5"
B Overall machine width	2.81 m	9' 2"
C Maximum height	5.04 m	16' 6"
D Minimum height	3.22 m	10' 7"
E Maximum truck clearance	4.75 m	15' 7"
Rotor ground clearance	305 mm	12"
Conveyor swing	45 degrees left or right of center	
Collecting conveyor width	1020 mm	40"
Upper conveyor width	915 mm	36"
Inside turning radius	4.66 m	15' 4"

Shipping

F Length of base machine	8.25 m	27'
Length (conveyor down)	15.7 m	51' 6"
G Maximum height	2.98 m	9' 9"
H Maximum width	2.58 m	8' 5"

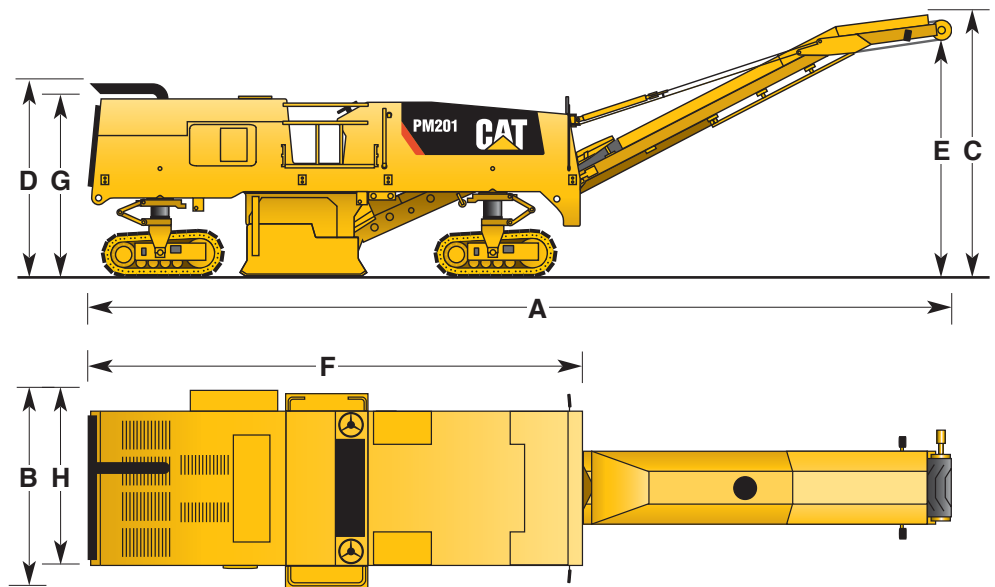

Brakes

Primary Brake Features

- Closed-loop hydrostatic drive provides dynamic braking during normal operation.

Parking Brake Features

- Spring-applied/hydraulically-released multiple disc type brake mounted on each gear reducer. Secondary brakes are activated by a button on the operator's console, loss of hydraulic pressure in the brake circuit or when the engine is shut down.
- Propel pump is destroyed when parking brake is engaged. Propel lever must be returned to neutral after brake is released before machine will propel.

Weights

Operating Weights*

Machine	35 110 kg	77,420 lb
on front tracks	19 310 kg	42,580 lb
on rear tracks	15 800 kg	34,840 lb

Weights shown are approximate and include coolant, lubricants, full fuel tank, full water tank and a 75 kg (165 lb) operator.

Shipping Weights*

Machine	30 840 kg	68,000 lb
on front tracks	16 655 kg	36,720 lb
on rear tracks	14 185 kg	31,280 lb

Weights shown are approximate and include coolant, lubricants, 50% fuel level and empty water tank.

*Weights do not include rotor. Include the appropriate rotor below to get the total weight required.

Rotor Configurations (add to above figures)

Conical	4055 kg	8942 lb
Breakaway	3035 kg	6687 lb
Weld-on	2945 kg	6488 lb

Rotor weights include cutting tools.

Grade and Slope Control

Machine elevation – rotor depth and cross slope controlled manually by operator is standard. Automatic rotor depth and slope control is optional and features electronic over hydraulic control. System can be configured with contacting or non-contacting grade sensors. Slope sensor adds versatility.

Features

- Machine elevation controls located on the operator's console and at ground level allows rotor depth and cross slope to be controlled manually. Visual depth gauge displays depth of cut.
- The optional AUTOMATIC grade and slope control automatically controls rotor depth and cross slope to a preset cutting depth. Setting cutting depth is easily accomplished first in manual mode by using the adjustment knob on the controller.
- Remote mounted control boxes allow manual or automatic operation from either the operator's station or at ground level. A cross communication function allows the operator to view and change settings of control boxes located on the opposite side of the machine. This allows operators a means to control both sides of a job from a single location. Constant read-out for rotor depth and cross slope are easily visible in direct sunlight.
- Sonic grade control sensors can be positioned on each side are easy to position and provides a consistent accuracy to ± 3 mm (1/8").
- Wire rope contacting grade sensor measures side plate movement that enables the entire length of the side plate to become a mini averaging ski for optimum grade matching.
- Sonic Averaging System features three non-contacting grade sensors or a combination of one contacting and two non-contacting sensors that mount on the side of the machine. Enables the entire length of the machine to become an averaging device. Eliminates the need for a contact type ski for greater machine maneuverability.
- Remote mounted control boxes and sonic grade sensors can be easily removed and securely stowed to prevent damage or theft.

Conveyor System

- Collecting conveyor is driven by two high torque hydraulic motors to ensure even belt tracking and clears out the rotor housing effectively.
- Variable belt speed for front loading conveyor controls loading of milled materials to closely match material type and amount.
- Boost function increases material handling to load long tractor trailers.
- Raise, lower and swing controlled from the operator's station and at two ground level control stations.

Collecting Conveyor

Length	3.74 m	12' 3"
Width	1020 mm	40"
Speed	189 mpm	620 fpm

Upper Conveyor

Length	8.31 m	27' 3"
Width	915 mm	36"
Max. speed	231 mpm	760 fpm
Speed w/boost	293 mpm	960 fpm
Swing (from center)	45 degrees	

Hydraulic System

- Pumps for propel, rotor drive, collecting and upper conveyors, auxiliary hydraulics and cooling fan are installed on the engine mounting pad.
- Hydraulic oil cooler located at the rear of the machine and arranged in a modular stacked design for efficient cooling and easy access for cleaning.
- Three-micron filtration on pressure side of auxiliary flow, seven-micron filtration on return side.
- Quick-connect hydraulic test ports simplify system diagnostics.

Service Refill Capacities

	Liters	Gallons
Fuel tank (useable)	946	250
Cooling system	80	21.1
Engine oil w/filter	64	17
Propel planetary gear reducer (each)	4.2	1.1
Rotor planetary gear reducer	14	3.7
Rotor mandrel coolant	307	81
Hydraulic tank	180	47.5
Rotor clutch sump	45	11.9
Water spray system	3787	1000

Water Spray System

- Hydraulically-driven centrifugal pump supplies water to spray nozzles for dust control and collecting belt lubrication.
- Centrifugal pump is rated at 206 L/min (55 gpm) at 276 kPa (40 psi).
- Water spray nozzles focuses the water spray in a flat fan pattern to the rotor for better cooling of cutting tools.
- Nozzles are easily removed for inspection and replacement without the need for tools.
- Automatic water spray system operates only when the rotor is engaged and machine is moving forward to conserve water.
- System includes gauges to monitor water pressure, replaceable filters, a low water level indicator and water control valves to conserve water usage.
- Water tank can be filled from the top of the machine or at ground level.

Electrical

The 24-volt electrical system consists of two maintenance-free Cat batteries. Electrical wiring is color-coded, numbered, wrapped in vinyl-coated nylon braid and labeled with component identifiers. The starting system provides 1365 cold cranking amps (cca). The system includes a 100-amp alternator.

Frame

Fabricated from heavy gauge steel plates and structural steel tubing. Track assembly features track frame stops to limit track angles to provide machine's ability to propel up inclines and out of deep cuts. Top of deck and steps features non-skid treads for sure footing.

Optional Equipment

Note: Some options listed may be an option in some areas and standard in others. Consult your dealer for specifics.

Hydraulically Operated Front Door provides an adjustable down pressure to prevent slabbing of the road surface in front of the machine resulting in optimum sizing and gradation.

Hydraulically Operated Side Plates allow ground personnel to raise/lower side plates to precisely place the rotor against gutter pans or when working near obstructions. Side plate features replaceable bolt-on carbide wear strips front and rear and a wear-resistant ski for reduced wear and long service life.

Upper Conveyor Cover helps avoid material spillage and blowing of fine materials.

Auxiliary Rotor Drive easily rotates the rotor for easy tool inspection and replacement. System includes a high torque motor and hydraulic hoses with quick-connect couplers. A ground level control box equipped with a toggle switch controls the direction of rotor rotation.

Automatic Grade and Slope System automatically controls rotor depth and cross slope to a preset cutting depth. System can be configured with contacting or non-contacting grade sensors. System also includes a cross slope sensor to meet slope applications/requirements in job specifications.

Contacting wire rope grade sensor measures side plate movement that enables the entire length of the side plate to become a mini averaging ski for optimum grade matching.

Non-contacting sonic grade sensors can be configured using one sensor per side or the Sonic Averaging System (SAS).

The Sonic Averaging System features three non-contacting grade sensors or a combination of one contacting and two non-contacting sensors that mount on the side of the machine. Enables the entire length of the machine to become an averaging device.

High Pressure Washdown System uses water from the water spray system tank to help with machine clean-up at the end of each day's operation. System includes a spray wand and 15.2 m (50 ft) of hose with a quick-connect coupler.

Conical Rotor features 190 point-attack carbide-tipped tools mounted in durable three-piece, patented quick release tool holders. Quick release conical tool holders have a tapered fit maintaining tightness in holder base. Mandrel has 12 carbide-faced replaceable loading paddles.

Breakaway Rotor features 170 point-attack carbide-tipped tools mounted in drive-in, knock-out tool holders. Bolt-on breakaway design tool holders allow for fast replacement without welding.

Weld-on Rotor features 147 point-attack carbide-tipped tools mounted in drive-in, knock-out tool holders. One-piece flighting has a thickness of 51 mm (2") to provide optimum material movement onto collecting conveyor and minimum wear.

PM201 Specifications

Operating Weights (with conical rotor)

Machine	39 165 kg	86,360 lb
on front tracks	21 540 kg	47,500 lb
on rear tracks	17 625 kg	38,860 lb

Shipping Weights (with conical rotor)

Machine	34 900 kg	76,950 lb
on front tracks	18 845 kg	41,550 lb
on rear tracks	16 055 kg	35,400 lb

Machine Dimensions (operating)

Overall length (conveyor up)	15.1 m	(49' 5")
Overall machine width	2.81 m	(9' 2")
Maximum height	5.04 m	(16' 6")
Minimum height	3.22 m	(10' 7")
Maximum truck clearance	4.75 m	(15' 7")
Rotor ground clearance	305 mm	(12")
Conveyor swing	45 degrees left or right of center	
Collecting conveyor width	1020 mm	(40")
Upper conveyor width	915 mm	(36")
Inside turning radius	4.66 m	(15' 4")

Machine Dimensions (shipping)

Overall length of base machine	8.25 m	(27')
Overall length (conveyor down)	15.7 m	(51' 6")
Maximum height	2.98 m	(9' 9")
Maximum width	2.58 m	(8' 5")

Power Train

Engine	C18 with ACERT® Technology	
Gross power	485 kW	650 hp
Speeds		
Operating	40 mpm	132 fpm
Travel	6.0 km/h	3.7 mph
Drive train (propel)	Hydrostatic w/planetary	
Track length	2045 mm	(80.5")
Track width	348 mm	(14")

Rotor Drive System

Rotor drive	Eleven-rib high tensile belt	
Transmission	Mechanical	
Clutch	Hydraulic/wet multi-disc	
Gear reduction	Caterpillar D8	
Speed	98 rpm	

Rotor

Cutting width	2100 mm	(83")
Cutting depth	305 mm	(12")
Number of tools		
Conical	190	
Breakaway	170	
Weld-on	147	
Tool spacing (tip)	15 mm	(0.6")

Miscellaneous

Electrical system	24 VDC	
Steering system	Front/Rear	
Water tank capacity	3787 liters	1000 gal
Fuel capacity	946 liters	250 gal

Caterpillar offers a comprehensive line of profilers.

The PM102 and PM200 are designed to have the best productivity, reliability, versatility, visibility and ease of operation in their class.

Contact your local Caterpillar® dealer to learn more about the complete line of Caterpillar Paving Products.



PM102

Operating Weight	17 600 kg	38,810 lb
Gross Power (SAE J1995)	168 kW	225 hp
Cutting Width	1000 mm	40"
Cutting Depth	305 mm	12"
Propel Speeds		
Operating	27 mpm	89 fpm
Travel	4.1 km/h	2.5 mph
Rotor Drive	Six-rib high tensile belt	
Clutch	Hydraulic/dry multi-disc	



PM200

Operating Weight	30 900 kg	68,135 lb
Gross Power (SAE J1995)	429 kW	575 hp
Cutting Width	2010 mm	79"
Cutting Depth	320 mm	12.6"
Propel Speeds		
Operating	38 mpm	125 fpm
Travel	5.9 km/h	3.6 mph
Rotor Drive	Two six-rib high tensile belts	
Clutch	Hydraulic/wet multi-disc	

© 2008 Caterpillar
All Rights Reserved.
www.cat.com
SAFETY.CAT.COM™

Featured machines in photography may include optional equipment.
Materials and specifications are subject to change without notice.

QEHQ1146-01 (03/08)

CAT, CATERPILLAR, their respective logos, "Caterpillar Yellow" and the POWER EDGE trade dress, as well as corporate and product identity used herein, are trademarks of Caterpillar and may not be used without permission.

CATERPILLAR®