

**PK 40002 EH**

**THE POWER LINK  
CABLE WINCH OFFERS  
INCREASED OPERATOR  
FRIENDLINESS**

**LIFETIME EXCELLENCE**



# LIFETIME EXCELLENCE

PALFINGER loader cranes are convincing due to their superior life-cycle performance. They are the most economical and also the most reliable over the entire product life. From solution finding to resale.

- **Better solutions**
- **Better efficiency**
- **Better ergonomics**
- **Higher availability**
- **More reliability**
- **Better ecology**
- **Higher serviceability**
- **Higher value retention**



# NEW CONTEMPORARY DESIGN

- More efficiency with fly jib thanks to DPS Plus
- Perfect appearance and extremely high value retention thanks to coating technology
- Additional applications thanks to Power Link Plus
- More lifting power due to E-HPLS
- Increased operating times due to low-maintenance extension system





# FIRST-RATE IN DESIGN AND PERFORMANCE

## 12 Highlights



### Continuous slewing system

Unrestricted movement

More efficient in operation due to faster loading cycles, since the crane can be slewed over a shorter distance. The crane works more efficiently and faster.



### Power Link Plus

High variety of uses

With the 15-degree reverse linkage system, you can reach through low door openings and also work inside buildings. Heavy crane work – even in difficult conditions.



### Low-maintenance extension system

Reduces service time

With sliding elements made of synthetic material and the high-quality KTL coating, this boom system significantly simplifies service performed by the operator. This saves time and money – and protects the environment.

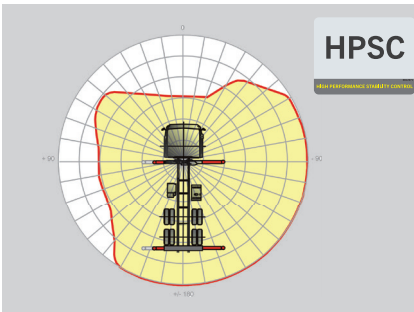

### HPSC

Maximum utilisation of the working range

The variable stabiliser positioning of the High Performance Stability Control System makes it possible to utilise the lifting capacity to the maximum. It enables working within tight spaces.

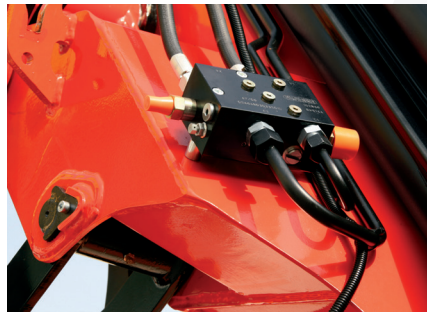

### High Speed Extension

For efficient assignments

The High Speed Extension speeds up the extension boom system. Crane works faster and more efficiently.



### Radio remote control

Dialogue with the operator

PALFINGER radio remote controls are equipped with linear lever or cross lever and provide the greatest possible comfort for the operator. All EH models with LED-Display inform the crane operator about the different operating conditions.



**Power Link cable winch**

More comfort in cable winch operation

Characterised by low installation height, it is ideal for working inside buildings and transports with the crane boom unfolded. The Comfort Cable Routing reduces set-up times to a minimum.



**Functional design**

Practical and attractive

Robust plastic covers protect crane parts against dirt and damage. Better appearance and increased operational comfort – during the entire lifetime.



**Coating technology**

Top quality surface protection at a glance

The KTL coating lays the foundation for a perfect surface protection. Afterwards the components are either coated in the powder-coating facility or are finished with a two-components-topcoat. High value retention and excellent corrosion protection for the whole life of a crane.



**Hose equipment for attachments**

Versatile and user-friendly

The hose equipment offers an easy means of connecting auxiliary equipment. The hose equipment is guided in hose trays for protection.

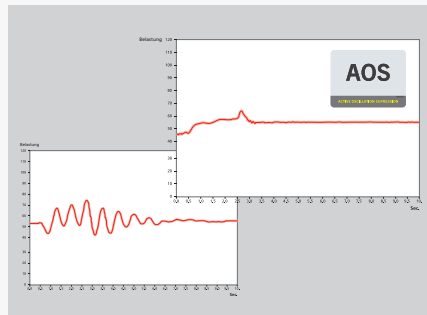

**AOS**

Maximum precision and safety

The active oscillation suppression system prevents „post-oscillation“ in the event of rapid braking or load changes. The stress peaks on the extension boom system are reduced and material fatigue and wear are minimised. This increases the resale value.



**DPS Plus**

More efficient fly-jib operation

The Dual Power System allows multiple uses of the crane both for large outreaches as well as for heavy load operation.



\*Optional features / country-specific equipment

PK 40002

# HIGH PERFORMANCE

Perfect for high outreaches.

C

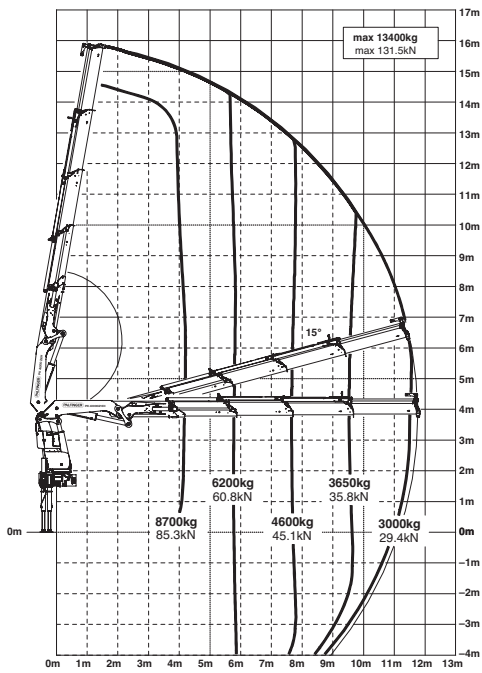

E

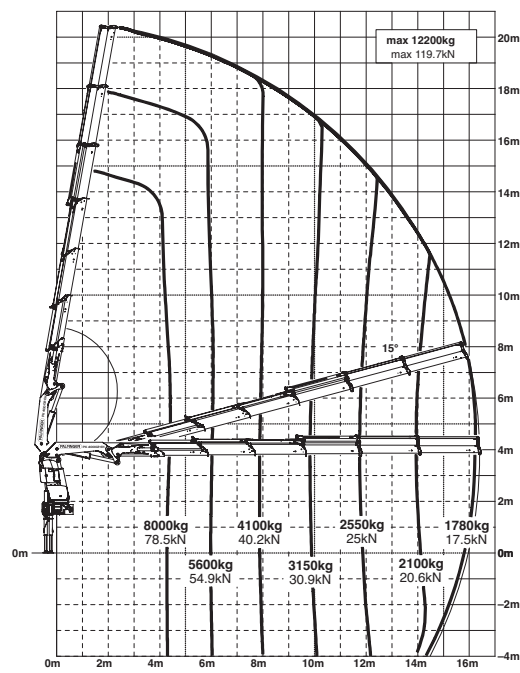

D PJ 125 E JV1 DPS Plus

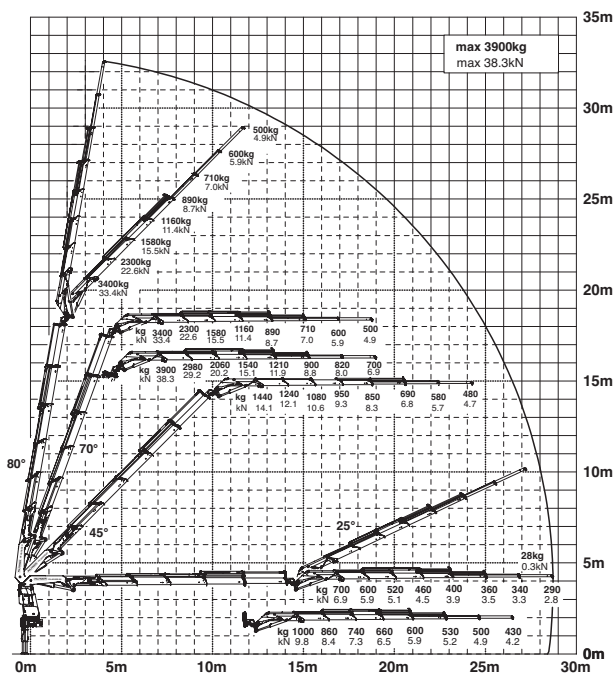

E PJ 080C JV2 DPS Plus

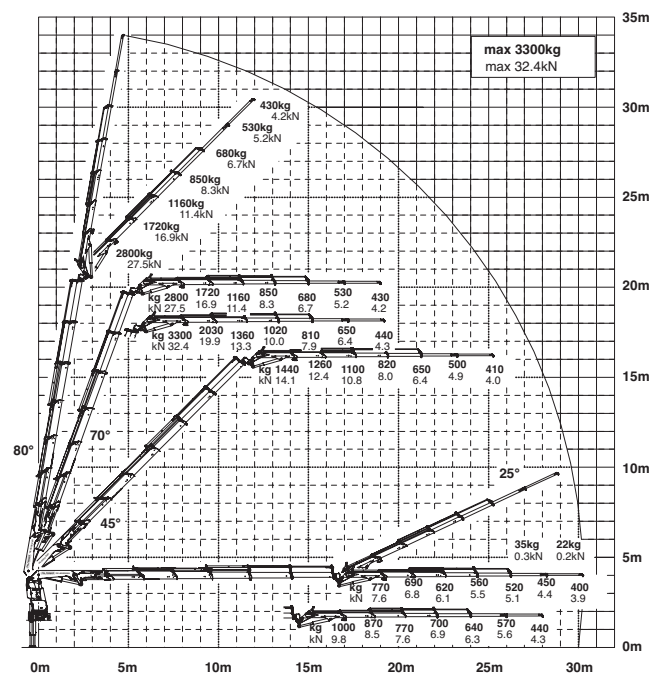

The outreaches stated are with a boom angle of 20° and are therefore not the maximum.



## Lifting capacities

**G**

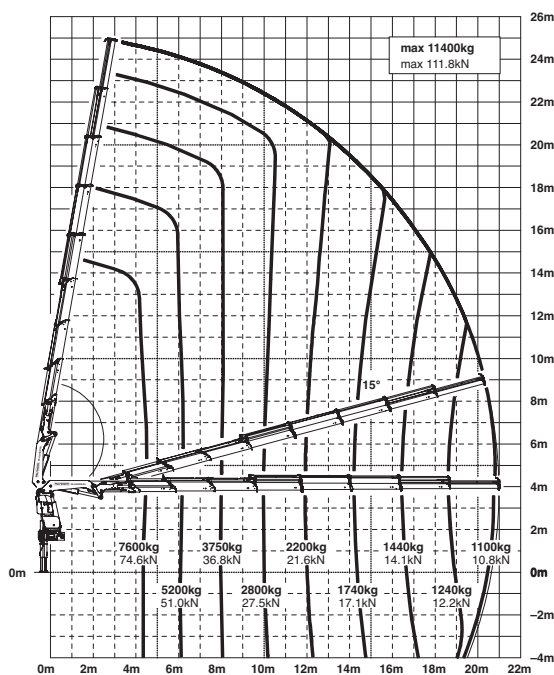

## F PJ 060B JV2 DPS Plus

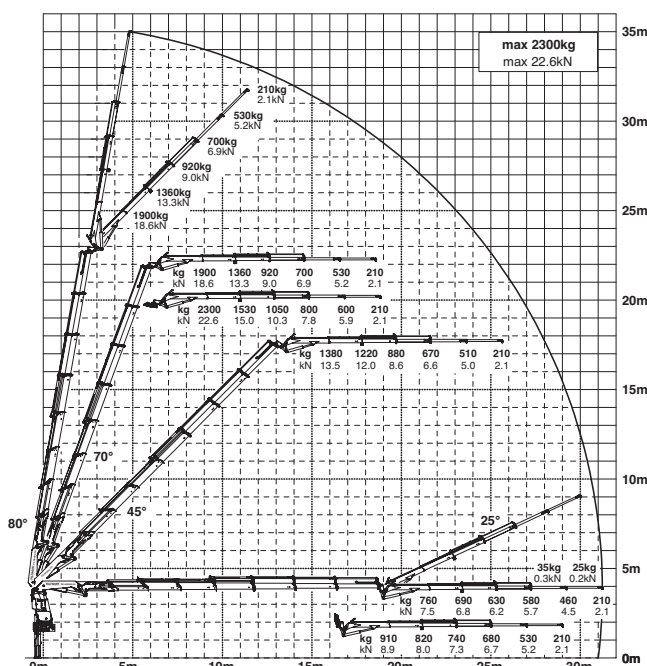

max.		14300 kg	31500 lbs	A
4.1 m	13' 5"	9300 kg	20500 lbs	
5.8 m	19' 0"	6700 kg	14700 lbs	
7.6 m	24' 11"	5100 kg	11200 lbs	

max.		13900 kg	30640 lbs	B
4.1 m	13' 5"	9100 kg	20000 lbs	
5.8 m	19' 0"	6400 kg	14100 lbs	
7.6 m	24' 11"	4850 kg	10700 lbs	
9.5 m	31' 2"	3900 kg	8600 lbs	

max.		13400 kg	29540 lbs	C
4.2 m	13' 9"	8700 kg	19300 lbs	
5.8 m	19' 0"	6200 kg	13500 lbs	
7.6 m	24' 11"	4600 kg	10200 lbs	
9.6 m	31' 6"	3650 kg	8000 lbs	
11.6 m	38' 1"	3000 kg	6600 lbs	

max.		12700 kg	27990 lbs	D
4.3 m	14' 1"	8400 kg	18400 lbs	
6.0 m	19' 8"	5900 kg	12900 lbs	
7.8 m	25' 7"	4350 kg	9600 lbs	
9.7 m	31' 10"	3400 kg	7500 lbs	
11.7 m	38' 5"	2750 kg	6100 lbs	
13.9 m	45' 7"	2300 kg	5100 lbs	

max.		12200 kg	26890 lbs	E
4.4 m	14' 5"	8000 kg	17700 lbs	
6.1 m	20' 0"	5600 kg	12300 lbs	
7.9 m	25' 11"	4100 kg	9100 lbs	
9.8 m	32' 2"	3150 kg	7000 lbs	
11.8 m	38' 9"	2550 kg	5600 lbs	
14.0 m	45' 11"	2100 kg	4600 lbs	
16.3 m	53' 6"	1780 kg	3950 lbs	

max.		11700 kg	25790 lbs	F
4.5 m	14' 9"	7700 kg	17000 lbs	
6.2 m	20' 4"	5400 kg	11800 lbs	
8.0 m	26' 3"	3900 kg	8600 lbs	
9.9 m	32' 6"	3000 kg	6600 lbs	
11.9 m	39' 1"	2350 kg	5200 lbs	
14.1 m	46' 3"	1900 kg	4200 lbs	
16.4 m	53' 10"	1600 kg	3550 lbs	
18.6 m	61' 0"	1400 kg	3100 lbs	

max.		11400 kg	25130 lbs	G
4.5 m	14' 9"	7600 kg	16700 lbs	
6.2 m	20' 4"	5200 kg	11500 lbs	
8.0 m	26' 3"	3750 kg	8300 lbs	
9.9 m	32' 6"	2800 kg	6200 lbs	
12.0 m	39' 4"	2200 kg	4850 lbs	
14.2 m	46' 7"	1740 kg	3850 lbs	
16.4 m	53' 10"	1440 kg	3200 lbs	
18.6 m	61' 0"	1240 kg	2750 lbs	
20.8 m	68' 3"	1100 kg	2450 lbs	
23.0 m*	75' 6"	900 kg	1980 lbs	
25.0 m*	82' 0"	600 kg	1320 lbs	

\*mechanical extension

# PERFECT DIMENSIONS

## EXTENSION BOOM VARIATIONS

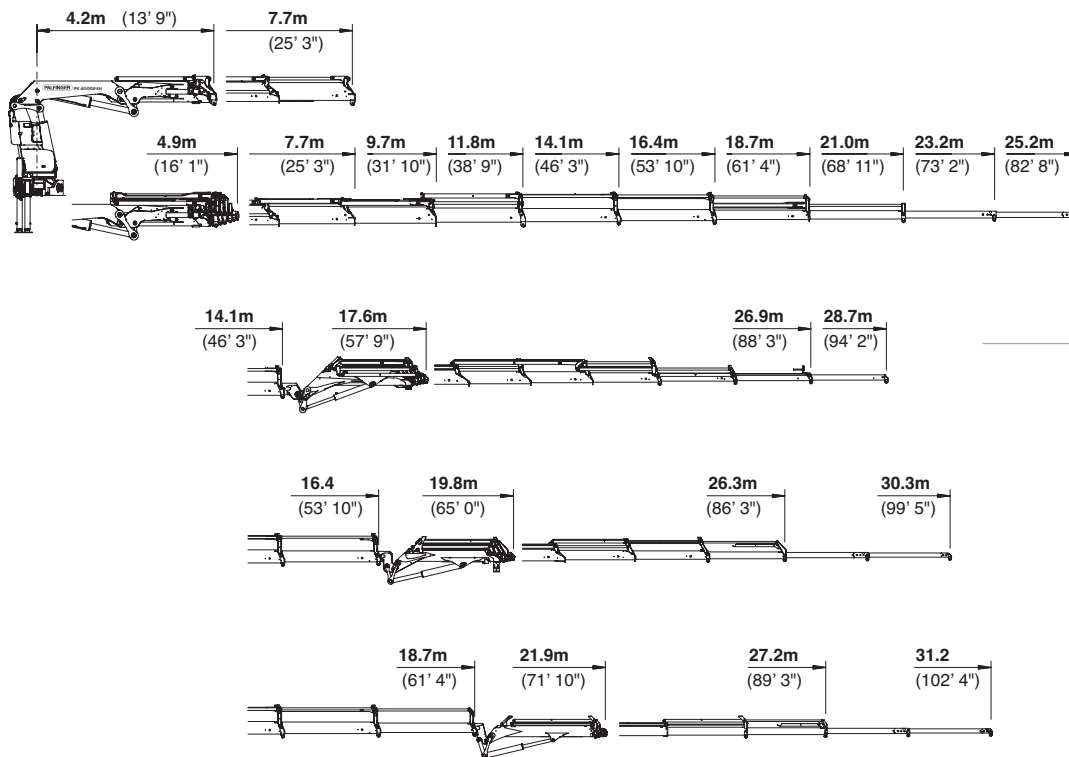

## DIMENSIONS

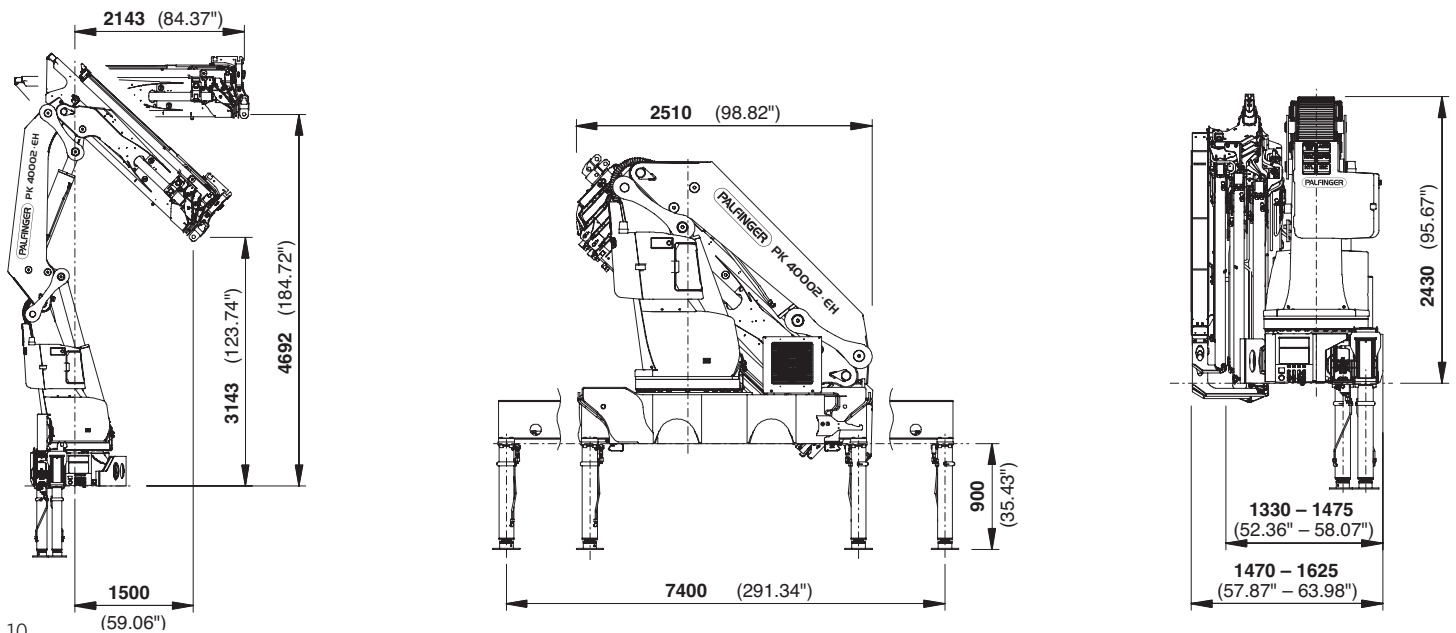

## Technical specifications

### EN 12999 HC1 HD4/B3

#### PK 40002 EH

Max. lifting moment	39.3 mt/385.5 kNm	284330 ft.lbs
Max. lifting capacity	14600 kg/143.2 kN	32190 lbs
Max. hydraulic outreach	21.0 m	68' 11"
Max. manual outreach	25.2 m	82' 8"
max. outreach (with fly-jib)	31.2 m	102' 4"
Slewing angle	endless	

#### D PJ125E JV1

Slewing torque with 1 gear	3.8 mt/37.3 kNm	27510 ft.lbs
Slewing torque with 2 gears	5.0 mt/49.1 kNm	36210 ft.lbs
Stabiliser spread	7.4 m	24' 3"
Fitting space required (min./max.)	1.33 m / 4' 4"	1.47 m / 4' 10"
Width folded	2.51 m	8' 3"

#### E PJ080C JV2

Max. operating pressure	350 bar	5075 psi
Recommended pump capacity	from 80 l/min to 100 l/min	21.1 US gal./min 26.4 US gal./min
Dead weight (std.)	3851 kg	8490 lbs

#### F PJ060B JV2

## Package model

- E-HPLS
- Paltronic 50
- Radio remote control with LED display
- Danfoss control valve or PVG2000
- 10.5 kW oil cooler



KP-HPK4002EM3+EN

Cranes shown in the leaflet are partially optional equipped and do not always correspond to the standard version. Country-specific regulations must be observed. Dimensions may vary. Subject to technical changes, errors and translation mistakes.