

# KOMATSU

## PC228USLC-11

EU Stage V Engine

HYDRAULIC EXCAVATOR

PC228



**ENGINE POWER**

123 kW / 165 HP @ 2.000 rpm

**OPERATING WEIGHT**

23.460 - 26.050 kg

**BUCKET CAPACITY**

max. 1,49 m<sup>3</sup>

# Walk-Around

PC228USLG-11



**ENGINE POWER**

123 kW / 165 HP @ 2.000 rpm

**OPERATING WEIGHT**

23.460 - 26.050 kg

**BUCKET CAPACITY**

max. 1,49 m<sup>3</sup>



## EXCEPTIONAL WORKABILITY AND ENVIRONMENTAL PERFORMANCE

### ***Powerful and Environmentally Friendly***

- EU Stage V engine
- Adjustable idle shutdown
- Komatsu fuel-saving technology
- Viscous engine fan clutch
- Up to 21% higher lifting capacity

### ***Maximised Efficiency***

- Increased productivity
- Built-in versatility and superior productivity
- Short tail swing and exceptional stability
- Enhanced engine management
- Improved hydraulic efficiency
- Komatsu Integrated Attachment Control (KIAC)

### ***First-Class Comfort***

- Fully air-suspended operator seat
- Low-noise design
- Widescreen monitor with evolutionary interface
- Improved operator convenience

### ***Safety First***

- Komatsu SpaceCab™
- Improved monitoring system
- Neutral position detection system
- KomVision surround view system

### ***Quality You Can Rely On***

- Komatsu-quality components
- Extensive dealer support network

### ***KOMTRAX***

- Komatsu Wireless Monitoring System
- 3G mobile communications
- Integrated communication antenna
- Increased operational data and reports



A maintenance program  
for Komatsu customers



# Powerful and Environmentally Friendly



## Higher productivity

The PC228USLC-11 is quick and precise. It features a powerful Komatsu EU Stage V engine, Komatsu's Closed Center Load Sensing (CLSS) hydraulic system and first-class Komatsu comfort to provide a fast response and unrivalled productivity for its class.

## Komatsu fuel-saving technology

Fuel consumption on the PC228USLC-11 is lower by up to 6%. Engine management is enhanced. The variable speed matching of the engine and hydraulic pump and a viscous fan clutch guarantee efficiency and precision during single and combined movements.

## Adjustable idle shutdown

The Komatsu auto idle shutdown automatically turns off the engine after it idles for a set period of time. This feature can easily be programmed from 5 to 60 minutes, to reduce unnecessary fuel consumption and exhaust emissions, and to lower operating costs. An Eco-gauge and the Eco guidance tips on the cab monitor further encourage efficient operations.

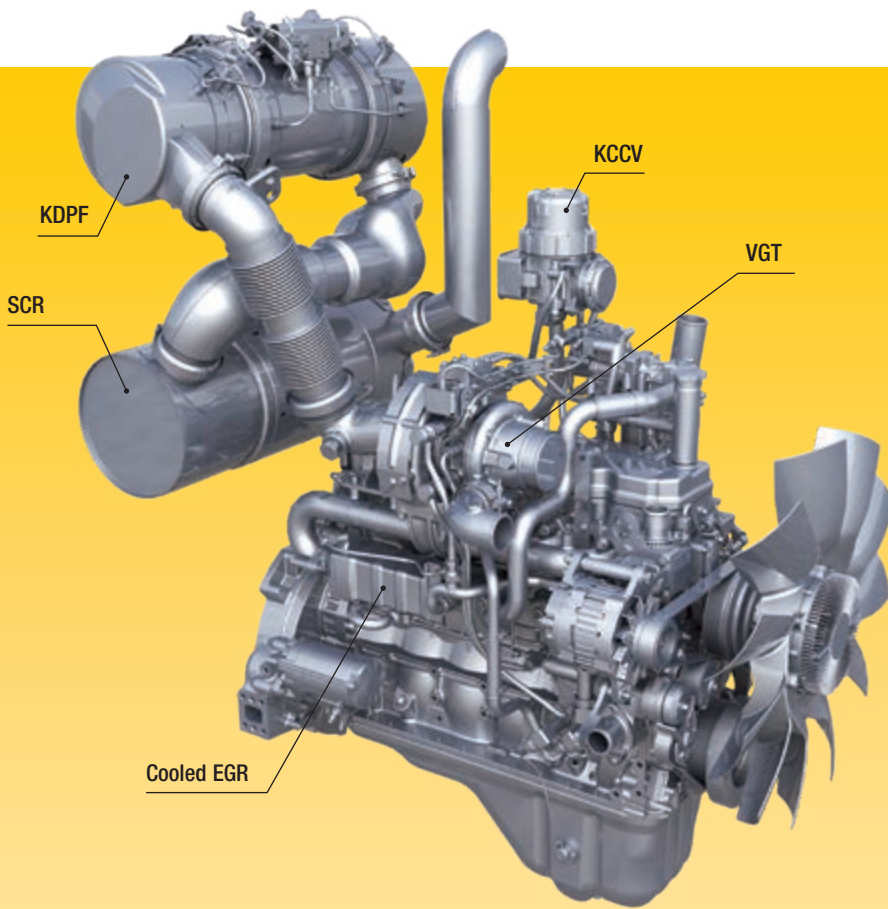

### Komatsu EU Stage V

The Komatsu EU Stage V engine is productive, dependable and efficient. With ultra-low emissions, it provides a lower environmental impact and a superior performance to help reduce operating costs and lets the operator work in complete peace of mind.

### Heavy-duty aftertreatment

The aftertreatment system combines a Komatsu Diesel Particulate Filter (KDPF) and Selective Catalytic Reduction (SCR). The SCR injects the correct amount of AdBlue® into the system at the proper rate to break down NOx into water (H<sub>2</sub>O) and non-toxic nitrogen gas (N<sub>2</sub>). NOx emissions are reduced by 80% vs. EU Stage IIIB engines.

#### Exhaust Gas Recirculation (EGR)

Cooled EGR is a technology well-proven in current Komatsu engines. The increased capacity of the EGR cooler now ensures very low NOx emissions and a better engine performance.

#### Komatsu Closed Crankcase Ventilation (KCCV)

Crankcase emissions (blow-by gas) are passed through a CCV filter. The oil mist trapped in the filter is returned back to the crankcase while the filtered gas is returned to the air intake.

#### High-Pressure Common Rail (HPCR)

To achieve complete fuel burn and lower exhaust emissions, the heavy-duty High-Pressure Common Rail fuel injection system is computer controlled to deliver a precise quantity of pressurised fuel into the redesigned engine combustion chamber by multiple injections.

#### Variable Geometry Turbo (VGT)

The VGT provides optimal airflow to the engine combustion chamber under all speed and load conditions. Exhaust gas is cleaner, fuel economy is improved while machine power and performance are maintained.

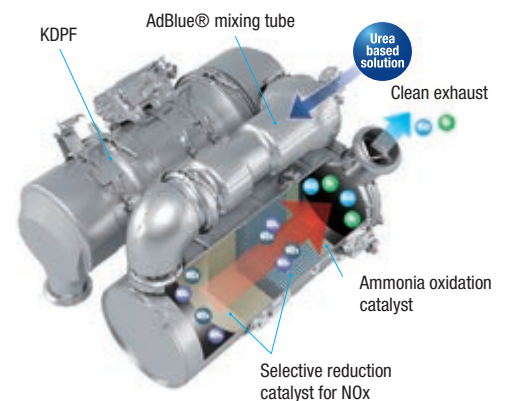

Eco-gauge, Eco guidance and fuel consumption gauge



ECO guidance record

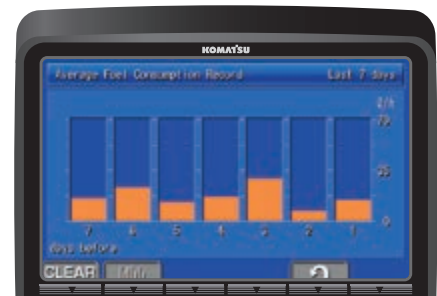

Fuel consumption history



# Maximised Efficiency

## Short tail swing and exceptional stability

The PC228USLC-11 has a rounded profile with minimal protrusions at both the front and the rear. Its ultra-short tail swing radius is perfect for work in tight spaces, particularly in urban areas, or for road construction, logging and demolition. Thanks to optimised packaging, the PC228USLC-11 is exceptionally stable.

Coupled with the machine's wide working range, this stability makes it ideal for any work requiring long reach, such as demolition jobs and slope cutting. With ample dumping reach available for loading operations, the operator can always work easily, efficiently and with absolute confidence.

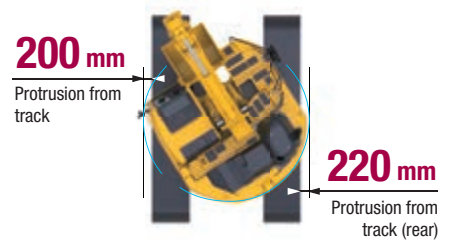
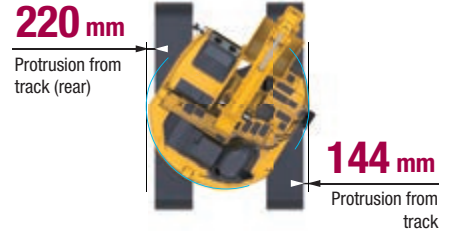

Two optional hydraulic lines to mount a variety of attachments



Full length track roller guards (optional)



Versatility at your fingertips: select the perfect setting for each job

## Built-in versatility

Powerful and precise, the Komatsu PC228USLC-11 is equipped to efficiently carry out any task your business requires. On all jobsites, big or small, for digging, trenching, landscaping or site preparation, the Komatsu hydraulic system always provides maximum productivity and control.

## A wide choice of options

Two optional attachment lines are available and 15 attachment memory settings are simply customised. Combined with a standard-fit hydraulic quick coupler power circuit, it's easier than ever to switch working styles. With a choice of arms and undercarriages, you can configure the PC228USLC-11 to match specific demands for transport, working envelope or duty.

## 6 working modes

The PC228USLC-11 delivers the power required with the lowest fuel usage. 6 working modes are available: Power, Lifting/Fine Operation, Breaker, Economy, Attachment Power and Attachment Economy. The operator can ideally balance the Economy mode between power and economy to match the work at hand. The oil flow delivered to hydraulic attachments is also adjustable directly on the class-leading widescreen monitor panel.

PC228USLC-11





Two-piece boom (option)



Komatsu Integrated Attachment Control (KIAC) for up to 15 tool presets for oil flow and pressure (option)



Dozer blade (option)



# First-Class Comfort

## Increased comfort

In the wide Komatsu SpaceCab™, a standard air-suspended high-back seat, heated for improved comfort and with fully adjustable armrests, is the centre of a comfortable and low-fatigue working environment. High visibility and ergonomic controls further assist to maximise the operator's productivity.

## Perfect operator convenience

In addition to the standard radio, the PC228USLC-11 has an auxiliary input for connecting external devices and play music through the cab speakers. Two 12-volt power ports are also incorporated in the cab. Proportional controls are fitted as standard for safe and precise operation of attachments.

## Low-noise design

Komatsu crawler excavators have very low external noise levels and are especially well-suited for work in confined spaces or urban areas. The optimal usage of sound insulation and of sound absorbing materials helps to make noise levels inside the cab comparable to those of an executive car.



Convenient, ergonomic and precise control: joysticks with proportional control button for attachments



Automatic air conditioner



Magazine box



# Information & Communication Technology



## Lower operating costs

Komatsu ICT contributes to the reduction of operating costs by assisting to comfortably and efficiently manage operations. It raises the level of customer satisfaction and the competitive edge of our products.

## Widescreen monitor

Installed with a choice of 26 languages, the widescreen monitor with simple switches and multifunction keys gives fingertip access to a large range of functions and operating info.

## An evolutionary interface

Helpful information is now easier than ever to find and understand with the upgraded monitor interface. An optimal main screen for the ongoing work can be selected simply by pressing the F3 key.

Operation Records (1Day)	
Working Hours (Engine On)	0.2 h
Average Fuel Consumption	23.0 l/h
Actual Working Hours	0.1 h
Avg Fuel Consumption (Actual Working)	23.0 l/h
Fuel Consumption	7. l
Idling Hours	0.1 h

Quick view on the operation logs



With KomVision, various camera view options are available whilst maintaining constant "birdview" from above the machine

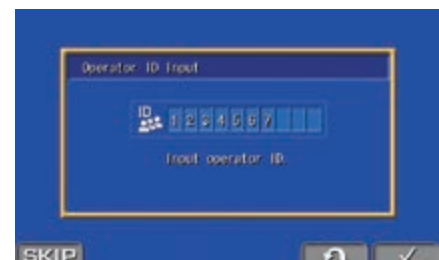

Operator identification function

# Safety First

## Optimal jobsite safety

Safety features on the Komatsu PC228USLC-11 comply with the latest industry standards and work in synergy to minimise risks to people in and around the machine. A neutral detection system for travel and work equipment levers increase jobsite safety, along with a seat belt caution indicator and an audible travel alarm. Highly durable anti-slip plates – with additional high friction covering – maintain long term traction performance.

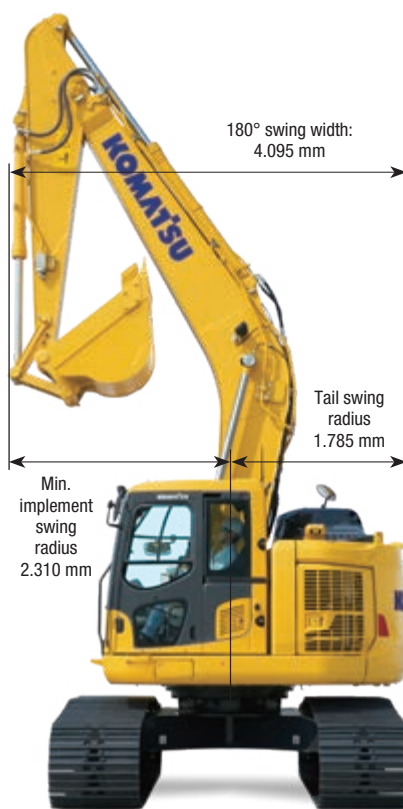

## Short tail swing radius

1,79 m – Because the tail of the PC228USLC-11 is more compact than conventional models, the operator's need to check behind him for movement.

## Short implement swing radius

2,31 m – Boom raising angle of the PC228USLC-11 is larger than the PC210-11, while front implement protrusion is lessened.



*KomVision cameras*



*Exceptional operator protection*



*Hand rails and anti-slip plates*

## KomVision

KomVision machine visibility gives the operator a constant clear view of the safety zone around the machine. This allows the operator to focus on the work at hand even in low light conditions.

## Komatsu SpaceCab™

The ROPS cab has a tubular steel frame and provides high shock absorbency, impact resistance and durability. The seat belt is well designed to keep the operator in the safety zone of the cab in the event of a rollover. Optionally the cab can be fitted with a Falling Object Protective System (FOPS) with openable front guard.

## Safe maintenance

Thermal guards around high temperature areas of the engine, protected fan belt and pulleys, a pump/engine partition that prevents hydraulic oil from spraying onto the engine, and exceptionally sturdy handrails: in Komatsu tradition, the highest safety level is provided for a fast and smooth maintenance.



# Quality You Can Rely On

## Komatsu-quality

With the latest computer techniques and a thorough test programme, Komatsu produces equipment to meet your highest standards.

All major components of the PC228USLC-11 are designed and directly manufactured by Komatsu, and essential machine functions are perfectly matched for a highly reliable and productive excavator.

## Rugged design

Maximum toughness and durability are the cornerstones of Komatsu's philosophy – along with safety and top class customer service. Single piece plates and castings are used in key areas of the machine's structure for good load distribution. Highly durable rubbing strips on the underside of the arm protect the structure against impact damage.

## Extensive support network

The extensive Komatsu distribution and dealer network is standing by to help keep your fleet in optimum condition. Customised servicing packages are available, with express availability of spare parts, to make sure that your Komatsu equipment continues to perform at its peak.



*The sliding door facilitates easy entrance in confined areas while reducing the risk of damage on roadways.*



*Durable and reliable undercarriage design for maximum protection*



*Cast boom foot and single piece boom plates*

# Easy Maintenance



## Central service points

Komatsu designed the PC228USLC-11 with centralised and conveniently located service points to make necessary inspections and maintenance quick and easy.

## Komatsu CARE™

Komatsu CARE™ is a maintenance program that comes as standard with your new Komatsu machine. It covers factory-scheduled maintenance, performed with Komatsu Genuine parts by Komatsu-trained technicians. Depending on your machine's engine, it also offers extended coverage of the Komatsu Diesel Particulate Filter (KDPF) and of the Selective Catalytic Reduction (SCR). Please contact your local Komatsu distributor for terms and conditions.



## Long-life oil filters

The Komatsu Genuine hydraulic oil filter uses high-performance filtering material for long replacement intervals, which significantly reduces maintenance costs.



## AdBlue® tank

For simple access, the AdBlue® tank is installed on the front stairway.

## Flexible warranty

When you purchase Komatsu equipment, you gain access to a broad range of programmes and services that have been designed to help you get the most from your investment. For example, Komatsu's Flexible Warranty Programme provides a range of extended warranty options on the machine and its components. These can be chosen to meet your individual needs and activities. This programme is designed to help reduce total operating costs.

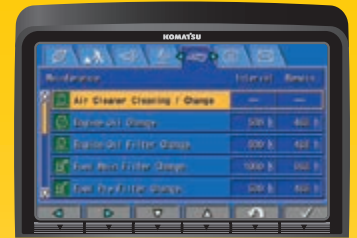

Basic maintenance screen

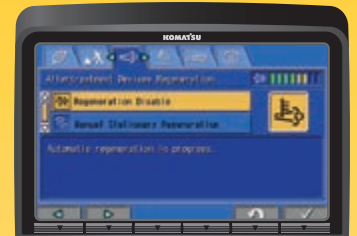

Aftertreatment device regeneration screen for the KDPF

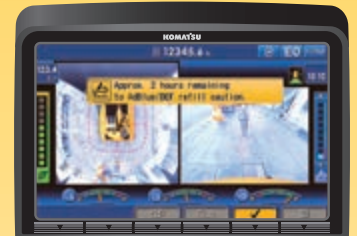

AdBlue® level and refill guidance





# KOMTRAX

## The way to higher productivity

KOMTRAX uses the latest wireless monitoring technology. Compatible on PC, smartphone or tablet, it delivers insightful and cost saving information about your fleet and equipment, and offers a wealth of information to facilitate peak machine performance. By creating a tightly integrated web of support it allows proactive and preventive maintenance and helps to efficiently run a business.



## Knowledge

You get quick answers to basic and critical questions about your machines – what they're doing, when they did it, where they're located, how they can be used more efficiently and when they need to be serviced. Performance data is relayed by wireless communication technology (satellite, GPRS or 3G depending on model) from the machine to a computer and to the local Komatsu distributor – who's readily available for expert analysis and feedback.

## Power

The detailed information that KOMTRAX puts at your fingertips 24 hours a day, 7 days a week gives the power to make better daily and long-term strategic decisions – at no extra cost. Problems can be anticipated, maintenance schedules customised, downtime minimised and machines kept where they belong: working on the jobsite.

## Convenience

KOMTRAX enables convenient fleet management on the web, wherever you are. Data is analysed and packaged specifically for effortless and intuitive viewing in maps, lists, graphs and charts. You can foresee eventual maintenance issues and required spare parts, and troubleshoot a problem before Komatsu technicians arrive on site.



# Specifications

## ENGINE

Model	Komatsu SAA6D107E-3
Type	Common rail direct injection, water-cooled, emissionised, turbocharged, after-cooled diesel
Engine power	
at rated engine speed	2.000 rpm
ISO 14396	123 kW/165 HP
ISO 9249 (net engine power)	123 kW/165 HP
No. of cylinders	6
Bore × stroke	107 × 124 mm
Displacement	6,69 l
Air filter type	Double element type with monitor panel dust indicator and auto dust evacuator
Cooling	Suction type cooling fan with radiator fly screen
Fuel	Diesel fuel, conforming to EN590 Class 2/Grade D. Paraffinic fuel capability (HVO, GTL, BTL), conforming to EN 15940:2016

## HYDRAULIC SYSTEM

Type	HydrauMind. Closed-centre system with load sensing and pressure compensation valves
Additional circuits	2 additional circuits with proportional control can be installed
Main pump	2 variable displacement piston pumps supplying boom, arm, bucket, swing and travel circuits
Maximum pump flow	490 l/min
Relief valve settings	
Implement	380 kg/cm <sup>2</sup>
Travel	380 kg/cm <sup>2</sup>
Swing	300 kg/cm <sup>2</sup>
Pilot circuit	33 kg/cm <sup>2</sup>

## SERVICE REFILL CAPACITIES

Fuel tank	290 l
Radiator	30 l
Engine oil	23,1 l
Swing drive	6,5 l
Hydraulic tank	126 l
Final drive (each side)	5,0 l
AdBlue® tank	13 l

## OPERATING WEIGHT (APPR.)

	MONO BOOM		TWO-PIECE BOOM	
	Operating weight	Ground pressure	Operating weight	Ground pressure
Triple grouser shoes				
600 mm (with optional dozer blade)	23.600 (26.050) kg	0,50 (0,55) kg/cm <sup>2</sup>	24.440 kg	0,52 kg/cm <sup>2</sup>
700 mm	23.870 kg	0,43 kg/cm <sup>2</sup>	24.710 kg	0,45 kg/cm <sup>2</sup>
800 mm	24.150 kg	0,38 kg/cm <sup>2</sup>	24.990 kg	0,40 kg/cm <sup>2</sup>
600 mm road liner	23.460 kg	0,49 kg/cm <sup>2</sup>	24.300 kg	0,51 kg/cm <sup>2</sup>

Operating weight, including specified work equipment, 2,9 m arm, 650 kg bucket, operator, lubricant, coolant, full fuel tank and the standard equipment.

## SWING SYSTEM

Type	Axial piston motor driving through planetary double reduction gearbox
Swing lock	Electrically actuated wet multidisc brake integrated into swing motor
Swing speed	0 - 11 rpm
Swing torque	65 kNm

## DRIVES AND BRAKES

Steering control	2 levers with pedals giving full independent control of each track
Drive method	Hydrostatic
Travel operation	Automatic 3-speed selection
Gradeability	70%, 35°
Max. travel speeds	
Lo / Mi / Hi	3,0 / 4,1 / 5,5 km/h
Maximum drawbar pull	20.600 kg
Brake system	Hydraulically operated discs in each travel motor

## UNDERCARRIAGE

Construction	X-frame centre section with box section track frames
Track assembly	
Type	Fully sealed
Shoes (each side)	49
Tension	Combined spring and hydraulic unit
Rollers	
Track rollers (each side)	9
Carrier rollers (each side)	2

## ENVIRONMENT

Engine emissions	Fully complies with EU Stage V exhaust emission regulations
Noise levels	
LwA external	100 dB(A) (2000/14/EC Stage II)
LpA operator ear	71 dB(A) (ISO 6396 dynamic test)
Vibration levels (EN 12096:1997)	
Hand/arm	≤ 2,5 m/s <sup>2</sup> (uncertainty K = 0,51 m/s <sup>2</sup> )
Body	≤ 0,5 m/s <sup>2</sup> (uncertainty K = 0,30 m/s <sup>2</sup> )
Contains fluorinated greenhouse gas HFC-134a (GWP 1430). Quantity of gas 0,8 kg, CO <sub>2</sub> equivalent 1,14 t	



# Dimensions & Performance Figures

## MACHINE DIMENSIONS

A	Overall width of upper structure	2.980 mm
B	Overall height (top of cab)	3.065 mm
B'	Overall height (top of handrail)	3.255 mm
C	Overall length of basic machine	4.450 mm
D	Tail length	1.785 mm
	Tail swing radius	1.785 mm
E	Clearance under counterweight	1.075 mm
F	Machine tail height	2.915 mm
G	Ground clearance	440 mm
H	Tumbler centre distance	3.655 mm
I	Track length	4.450 mm
J	Track gauge	2.380 mm
K	Track shoe width	600, 700, 800 mm
L	Overall track width with 600 mm shoes	2.980 mm
	Overall track width with 700 mm shoes	3.080 mm
	Overall track width with 800 mm shoes	3.180 mm
Q	Distance, swing center to blade	3.040 mm
R	Blade, max. lifting height	635 mm
S	Height of blade	745 mm
T	Blade, max. digging depth	390 mm
	Blade width	2.985 mm

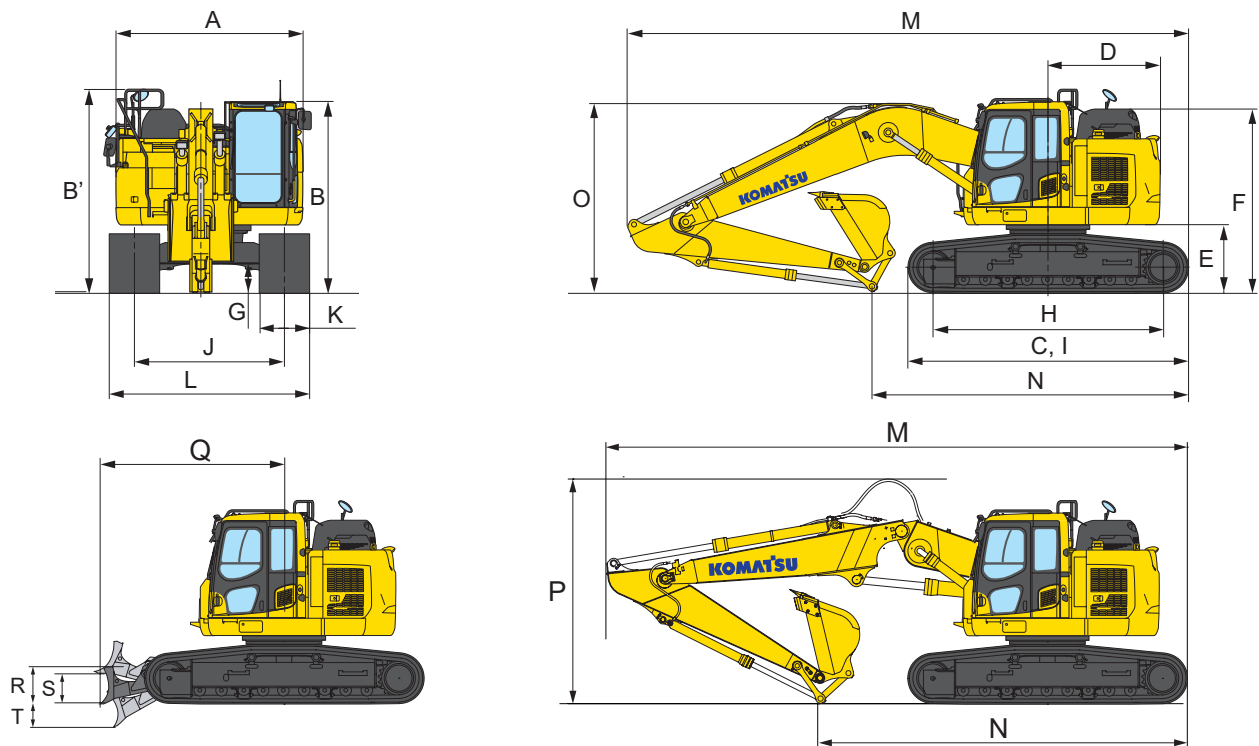

## TRANSPORT DIMENSIONS

	MONO BOOM		TWO-PIECE BOOM	
Arm length	2,4 m	2,9 m	2,4 m	2,9 m
M Transport length	8.980 mm	8.920 mm	9.190 mm	9.285 mm
N Length on ground (transport)	5.890 mm	5.050 mm	6.595 mm	5.855 mm
O Overall height (to top of boom)	3.165 mm	3.040 mm	-	-
P Overall height (to top of hose)	-	-	3.610 mm	3.575 mm

# Dimensions & Performance Figures

## MAX. BUCKET CAPACITY AND WEIGHT

	MONO BOOM	
Arm length	2,4 m	2,9 m
Material weight up to 1,2 t/m <sup>3</sup>	1,49 m <sup>3</sup> 1.100 kg	1,37 m <sup>3</sup> 1.000 kg
Material weight up to 1,5 t/m <sup>3</sup>	1,36 m <sup>3</sup> 1.100 kg	1,26 m <sup>3</sup> 950 kg
Material weight up to 1,8 t/m <sup>3</sup>	1,18 m <sup>3</sup> 900 kg	1,10 m <sup>3</sup> 875 kg

## MAX. BUCKET CAPACITY AND WEIGHT

	TWO-PIECE BOOM	
Arm length	2,4 m	2,9 m
Material weight up to 1,2 t/m <sup>3</sup>	1,43 m <sup>3</sup> 1.025 kg	1,32 m <sup>3</sup> 975 kg
Material weight up to 1,5 t/m <sup>3</sup>	1,22 m <sup>3</sup> 925 kg	1,12 m <sup>3</sup> 875 kg
Material weight up to 1,8 t/m <sup>3</sup>	1,06 m <sup>3</sup> 850 kg	0,97 m <sup>3</sup> 800 kg

Max. capacity and weight have been calculated according to ISO 10567:2007.  
Please consult with your distributor for the correct selection of buckets and attachments to suit the application.

## BUCKET AND ARM FORCE

Arm length	2,4 m	2,9 m
Bucket digging force	16.500 kg	14.100 kg
Bucket digging force at PowerMax	17.500 kg	15.200 kg
Arm crowd force	12.200 kg	10.300 kg
Arm crowd force at PowerMax	13.000 kg	11.000 kg





# Working Range

## MONO BOOM

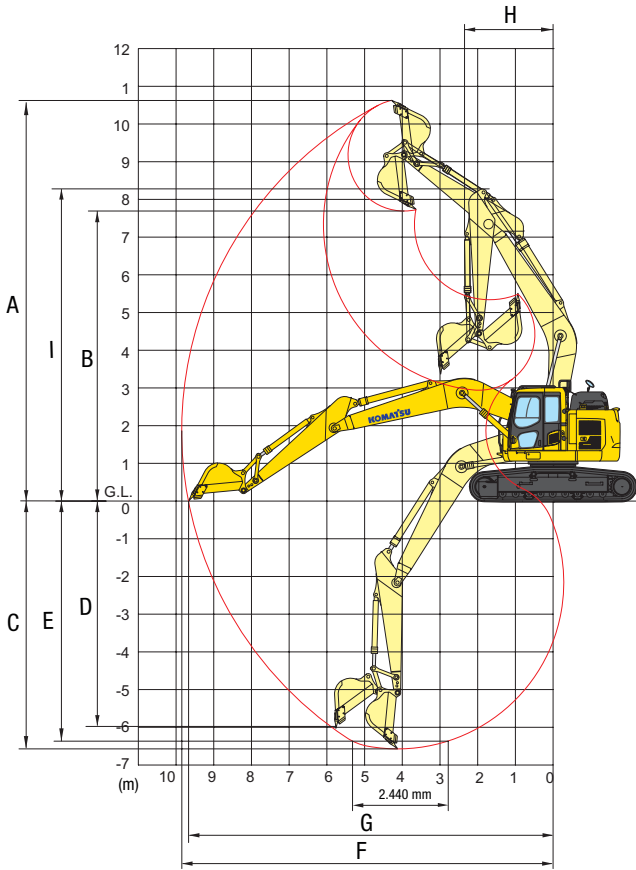

## TWO-PIECE BOOM

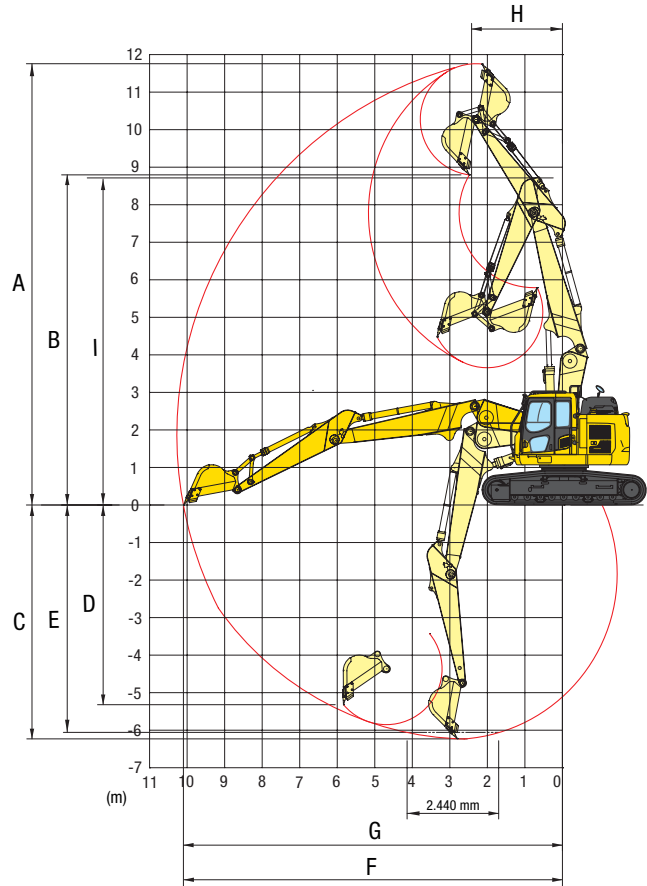

### WORKING RANGE

	MONO BOOM		TWO-PIECE BOOM	
	2,4 m	2,9 m	2,4 m	2,9 m
Arm length	2,4 m	2,9 m	2,4 m	2,9 m
A Max. digging height	10.380 mm	10.700 mm	11.305 mm	11.790 mm
B Max. dumping height	7.470 mm	7.825 mm	8.380 mm	8.830 mm
C Max. digging depth	6.095 mm	6.620 mm	5.725 mm	6.225 mm
D Max. vertical wall digging depth	5.315 mm	5.980 mm	4.750 mm	5.350 mm
E Max. digging depth of cut for 2,44 m level	5.840 mm	6.370 mm	5.535 mm	6.050 mm
F Max. digging reach	9.395 mm	9.875 mm	9.775 mm	10.270 mm
G Max. digging reach at ground level	9.205 mm	9.700 mm	9.595 mm	10.095 mm
H Min. swing radius	2.700 mm	2.310 mm	2.570 mm	2.370 mm
I Max. height at min. swing radius	8.340 mm	8.250 mm	8.735 mm	8.755 mm

# Lifting Capacity

## MONO BOOM

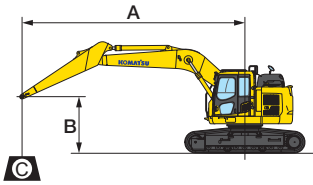

- A – Reach from swing center
- B – Bucket hook height
- C – Lifting capacities

- Rating over front
- Rating over side
- Rating at maximum reach

Weights:

With 2,4 m arm: bucket linkage and bucket cylinder: 360 kg

With 2,9 m arm: bucket linkage and bucket cylinder: 335 kg

With 700 mm shoes

Arm length	A				7,5 m		6,0 m		4,5 m		3,0 m		1,5 m	
	B													
 2,4 m	6,0 m	kg	*5.155	4.275			*6.615	5.385						
	4,5 m	kg	*5.215	3.615	5.675	3.725	*7.305	5.185	*8.385	7.895				
	3,0 m	kg	5.035	3.285	5.535	3.605	7.675	4.875	*11.055	7.295				
	1,5 m	kg	4.875	3.155	5.385	3.465	7.395	4.625	11.455	6.695				
	0,0 m	kg	4.975	3.185	5.275	3.365	7.175	4.425	11.075	6.385	*8.265	*8.265		
	-1,5 m	kg	5.405	3.435	5.255	3.345	7.085	4.345	10.985	6.305	*10.565	*10.565	*8.975	*8.975
 2,9 m	-3,0 m	kg	6.495	4.055			7.155	4.405	6.425	*18.305	12.285	*13.825	*13.825	
	-4,5 m	kg	*9.715	5.885					*10.945	6.735	*15.005	12.525		
	6,0 m	kg	*3.640	*3.640	*3.990	3.860								
	4,5 m	kg	*3.660	3.330	5.760	3.800	*6.740	5.290						
	3,0 m	kg	*3.810	3.060	5.600	3.660	7.810	4.990	*10.090	7.510	*14.590	14.010		
	1,5 m	kg	*4.100	2.940	5.430	3.500	7.490	4.700	11.680	6.890	*7.740	*7.740		
 2,9 m	0,0 m	kg	4.590	2.960	5.300	3.380	7.230	4.480	11.200	6.490	*6.080	*6.080		
	-1,5 m	kg	4.930	3.150	5.230	3.320	7.090	4.360	11.010	6.330	*10.190	*10.190	*6.060	*6.060
	-3,0 m	kg	5.730	3.610			7.100	4.370	11.080	6.390	*17.170	12.150	*10.620	*10.620
	-4,5 m	kg	7.840	4.810							*11.300	6.600	*16.750	12.550

## TWO-PIECE BOOM

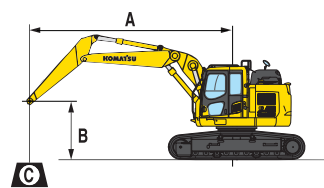

- A – Reach from swing center
- B – Bucket hook height
- C – Lifting capacities

- Rating over front
- Rating over side
- Rating at maximum reach

Weights:

With 2,4 m arm: bucket linkage and bucket cylinder: 360 kg

With 2,9 m arm: bucket linkage and bucket cylinder: 335 kg

With 600 mm shoes

Arm length	A				7,5 m		6,0 m		4,5 m		3,0 m		1,5 m	
	B													
 2,4 m	6,0 m	kg	*5.470	3.580			*7.200	4.850						
	4,5 m	kg	4.850	3.010	5.220	3.250	7.510	4.640	*9.520	7.220				
	3,0 m	kg	4.440	2.730	5.100	3.140	7.180	4.360	11.370	6.520				
	1,5 m	kg	4.320	2.630	4.960	3.020	6.890	4.100	10.760	6.010				
	0,0 m	kg	4.430	2.690	4.880	2.940	6.710	3.950	10.540	5.830				
	-1,5 m	kg	4.870	2.940	4.900	2.960	6.680	3.910	10.550	5.840				
 2,9 m	6,0 m	kg	*3.600	3.190	*4.910	3.400	*6.700	4.990						
	4,5 m	kg	*3.520	2.750	5.310	3.340	*7.380	4.770	*8.780	7.460				
	3,0 m	kg	*3.560	2.520	5.170	3.200	7.300	4.460	*10.860	6.760				
	1,5 m	kg	*3.730	2.430	5.010	3.060	6.980	4.180	10.960	6.170				
	0,0 m	kg	*4.050	2.470	4.900	2.960	6.760	3.990	10.610	5.890				
	-1,5 m	kg	4.400	2.670	4.870	2.930	6.680	3.910	10.540	5.830				

\* Load is limited by hydraulic capacity rather than tipping. Ratings are based on SAE Standard No. J1097. Rated loads do not exceed 87% of hydraulic lift capacity or 75% of tipping load. Lifting capacity stated is based on lifting with bare arm. When lifting with additional equipment installed to the arm, please subtract the weight of all additional equipment from the values stated.



# Lifting Capacity

## MONO BOOM - WITH DOZER BLADE

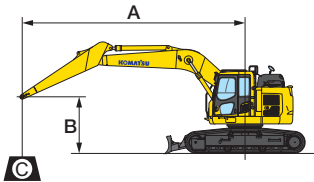

- A – Reach from swing center
- B – Bucket hook height
- C – Lifting capacities

- Rating over front
- Rating over side
- Rating at maximum reach

Weights:

With 2,4 m arm: bucket linkage and bucket cylinder: 360 kg

With 2,9 m arm: bucket linkage and bucket cylinder: 335 kg

With 600 mm shoes and dozer blade DOWN

Arm length	A		7,5 m		6,0 m		4,5 m		3,0 m		1,5 m	
	B											
<p>2,4 m</p>	6,0 m	kg	*5.630	4.490		*6.950	5.360					
	4,5 m	kg	*5.620	3.740		*7.560	5.200	*8.770	8.050			
	3,0 m	kg	*5.860	3.380	*7.510	3.570	*8.590	4.950	*11.100	7.440		
	1,5 m	kg	*6.370	3.250	*7.960	3.470	*9.600	4.710	*13.050	6.950		
	0,0 m	kg	*7.310	3.320	*8.230	3.400	*10.250	4.550	*13.910	6.720		
	-1,5 m	kg	*8.530	3.650			*10.300	4.510	*13.770	6.690	*12.720	*12.720
	-3,0 m	kg	*9.000	4.470			*9.320	4.600	*12.620	6.800	13.120	
-4,5 m	kg		7.050						7.140			
<p>2,9 m</p>	6,0 m	kg	*3.780	*3.780								
	4,5 m	kg	*3.760	3.410	*5.730	3.750	*7.020	5.310				
	3,0 m	kg	*3.880	3.120	*7.150	3.640	*8.120	5.050	*10.270	7.650		
	1,5 m	kg	*4.160	3.010	*7.720	3.510	*9.260	4.790	*12.480	7.100		
	0,0 m	kg	*4.670	3.050	*8.150	3.410	*10.090	4.600	*13.720	6.800	*7.150	*7.430
	-1,5 m	kg	*5.570	3.300	*7.380	3.380	*10.370	4.510	*13.950	6.700	*11.640	*11.640
	-3,0 m	kg	*7.460	3.900			*9.850	4.540	*13.190	6.760	*17.880	13.000
-4,5 m	kg		5.480						6.980		13.400	

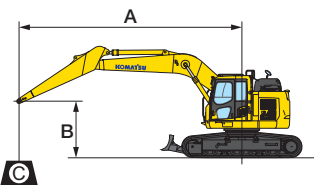

- A – Reach from swing center
- B – Bucket hook height
- C – Lifting capacities

- Rating over front
- Rating over side
- Rating at maximum reach

Weights:

With 2,4 m arm: bucket linkage and bucket cylinder: 360 kg

With 2,9 m arm: bucket linkage and bucket cylinder: 335 kg

With 600 mm shoes and dozer blade UP

Arm length	A		7,5 m		6,0 m		4,5 m		3,0 m		1,5 m	
	B											
<p>2,4 m</p>	6,0 m	kg	*5.630	4.490		*6.950	5.360					
	4,5 m	kg	5.260	3.740		7.420	5.200	8.770	8.050			
	3,0 m	kg	4.770	3.380	5.050	3.570	7.140	4.950	11.100	7.440		
	1,5 m	kg	4.620	3.250	4.940	3.470	6.870	4.710	10.780	6.950		
	0,0 m	kg	4.740	3.320	4.860	3.400	6.690	4.550	10.510	6.720	*12.720	
	-1,5 m	kg	5.250	3.650			6.640	4.510	10.470	6.690	13.120	
	-3,0 m	kg		4.470				4.600		6.800		
-4,5 m	kg		7.050						7.140			
<p>2,9 m</p>	6,0 m	kg	*3.780	*3.780								
	4,5 m	kg	*3.760	3.410	5.240	3.750	*7.020	5.310				
	3,0 m	kg	*3.880	3.120	5.120	3.640	7.250	5.050	*10.270	7.650		
	1,5 m	kg	*4.160	3.010	4.980	3.510	6.960	4.790	10.970	7.100		
	0,0 m	kg	4.340	3.050	4.880	3.410	6.740	4.600	10.600	6.800	*7.150	*7.150
	-1,5 m	kg	4.720	3.300	4.840	3.380	6.650	4.510	10.480	6.700	*11.640	*11.640
	-3,0 m	kg		3.900			6.680	4.540	10.550	6.760	13.000	*12.050
-4,5 m	kg		5.480						6.980		13.400	

\* Load is limited by hydraulic capacity rather than tipping. Ratings are based on SAE Standard No. J1097. Rated loads do not exceed 87% of hydraulic lift capacity or 75% of tipping load. Lifting capacity stated is based on lifting with bare arm. When lifting with additional equipment installed to the arm, please subtract the weight of all additional equipment from the values stated.

# Standard and Optional Equipment

## ENGINE

Komatsu SAA6D107E-3 turbocharged common rail direct injection diesel engine	●
EU Stage V compliant	●
Suction type cooling fan with radiator fly screen	●
Automatic engine warm-up system	●
Engine overheat prevention system	●
Fuel control dial	●
Auto-deceleration function	●
Adjustable idle shutdown	●
Engine key stop	●
Engine ignition can be password secured on request	●
Alternator 24 V/60 A	●
Starter motor 24 V/5,5 kW	●
Batteries 2 × 12 V/120 Ah	●

## HYDRAULIC SYSTEM

Electronic closed-centre load sensing (E-CLSS) hydraulic system (HydrauMind)	●
Pump and engine mutual control (PEMC) system	●
6-working mode selection system; Power mode, Economy mode, Breaker mode, Attachment Power and Attachment Economy mode, and Lifting/Fine Operation mode	●
PowerMax function	●
PPC wrist control levers for arm, boom, bucket and swing, with sliding proportional control for attachments and 3 auxiliary buttons	●
Prepared for hydraulic quick-coupler	●
Additional hydraulic functions	○
Komatsu Integrated Attachment Control (KIAC)	○

## UNDERCARRIAGE

Track frame under-guards	●
600 mm triple grouser shoes	●
700, 800 mm triple grouser shoes	○
600 mm road-liner (rubber) shoes	○
Full length track roller guards	○
Dozer blade (with 600 mm shoes only)	○

## CABIN

Reinforced safety SpaceCab™; Highly pressurised and tightly sealed hyper viscous mounted cab with tinted safety glass windows, large roof hatch, pull-up type front window with locking device, removable lower window, front window wiper with intermittent feature, cigarette lighter, ashtray, luggage shelf, floor mat	●
Heated, high-back air-suspended seat with lumbar support, console mounted height adjustable arm rests, and retractable seat belt	●
Automatic climate control system	●
12/24 Volt power supplies	●
Beverage holder	●
Radio	●
Auxiliary input (MP3 jack)	●
Lower wiper	○
Rain visor (not with OPG)	○

## SERVICE AND MAINTENANCE

Automatic fuel line de-aeration	●
Double element type air cleaner with dust indicator and auto dust evacuator	●
KOMTRAX – Komatsu wireless monitoring system (3G)	●
Komatsu CARE™ – a maintenance program for Komatsu customers	●
Multifunction video compatible colour monitor with Equipment Management and Monitoring System (EMMS) and efficiency guidance	●
Toolkit	●
Service points	○

## DRIVES AND BRAKES

Hydrostatic, 3-speed travel system with automatic shift and planetary gear type final drives, and hydraulic travel and parking brakes	●
PPC control levers and pedals for steering and travel	●

## LIGHTING SYSTEM

Working lights: 2 revolving frame, 1 boom (l.h.)	●
Additional working lights: 5 cab roof, 1 boom (r.h.), 1 counterweight (rear), additional revolving frame (l.h.), beacon and harness for 2 lamps (not included) in boom foot area	○

## SAFETY EQUIPMENT

KomVision surround view system	●
Electric horn	●
Overload warning device	●
Audible travel alarm	●
Boom safety valves	●
Large handrails, rear-view mirrors	●
Battery main switch	●
ROPS compliant to ISO 12117-2:2008	●
Emergency engine stop switch	●
Seat belt caution indicator	●
Neutral position detection system	●
Arm safety valve	●
OPG Level II front guard (FOPS), hinged type	○
OPG Level II top guard (FOPS)	○

## WORK EQUIPMENT

Mono boom	○
Two-piece boom	○
Bucket linkage with lifting eye	○
2,4 m; 2,9 m arms	○
Komatsu buckets	○
Komatsu breakers	○

## OTHER EQUIPMENT

Standard counterweight	●
Remote greasing for swing circle and pins	●
Electric refuelling pump with automatic shut-off function	●

Further equipment on request

- standard equipment
- optional equipment

Your Komatsu partner:

# KOMATSU

**Komatsu Europe  
International N.V.**

Mechelsesteenweg 586  
B-1800 VILVOORDE (BELGIUM)  
Tel. +32-2-255 24 11  
Fax +32-2-252 19 81  
[www.komatsu.eu](http://www.komatsu.eu)

UENSS18803 04/2020

**KOMATSU** is a trademark of Komatsu Ltd. Japan.

PG228USLG-11