

KOMATSU®

PC2000-11

Tier 4 Final Engine

HYDRAULIC EXCAVATOR

PC2000



Photos may include optional equipment.

HORSEPOWER

Gross: 1065 HP 794 kW @ 1800 rpm
Net: 1046 HP 780 kW @ 1800 rpm

OPERATING WEIGHT

445,179 – 456,926 lb
201930 – 207258 kg

STANDARD BUCKET CAPACITY

15.7–17.9 yd³
12.0–13.7 m³

WALK-AROUND

MORE PRODUCTIVE AND EFFICIENT

The PC2000-11 can load more trucks per shift. Increased engine power, a more efficient hydraulic system, and new engine-pump control logic provide faster cycle times and improved multifunction performance.

PC2000-11



Photos may include optional equipment.

HORSEPOWER

Gross: 1065 HP 794 kW @ 1800 rpm
Net: 1046 HP 780 kW @ 1800 rpm

OPERATING WEIGHT

445,179 – 456,926 lb
201930 – 207258 kg

STANDARD BUCKET CAPACITY

15.7–17.9 yd³
12.0–13.7 m³

Productivity, Efficiency, and Multifunction Performance

- **Faster cycle times and improved multifunction performance** **NEW**
- **Tier 4 Final emission-compliant engine with 1,046 net horsepower** **NEW**
- **Four selectable working modes to tailor machine performance to operating conditions** **NEW**
- **Power Plus (P+) mode increases productivity up to 12%** **NEW**
- **Redesigned hydraulic system monitors work equipment loads and optimizes hydraulic flow, based on operating conditions** **NEW**
- **Swing priority valve makes sure swing speed is available when needed** **UPGRADE**
- **Auto idle, auto-low idle, and auto engine shutdown reduce nonproductive idle time and reduces operating costs.** **NEW**

Reliability and Durability

- **Thicker, stronger boom plates and castings, highly resistant to bending and torsional stresses** **UPGRADE**
- **Strengthened center frame and track frame** **UPGRADE**
- **Larger diameter carrier rollers for extended service life** **UPGRADE**
- **New sealing package on work equipment cylinders to withstand the most abrasive applications** **UPGRADE**
- **Power module makes installation and removal of components easier, and reduces overhaul hours and cost.**

Accessibility and Operator Comfort

- **Operator's cab OPG level 2 (ISO 10262)**
- **Hydraulically operated stairway with 45° access** **NEW**
- **Secondary engine stop switches located at ground level, along walkway, and in cabin**
- **Fuel shut off valves located at ground level and along walkway**
- **Air-suspension seat, heated, with console-mounted arm rests** **NEW**
- **Two automatic, large capacity air conditioning units** **UPGRADE**
- **Extremely quiet, air pressurized cab, with a dynamic noise of 64.1 dB(A)** **UPGRADE**

Information, Communication, and Technology

- **7-inch, advanced, machine monitoring system with onboard diagnostics, no laptop required** **UPGRADE**
- **KomVision, bird's-eye view, 7-camera system with dedicated 10-inch display** **NEW**
- **Operator Identification System records KOMTRAX[®] machine operation and application data for up to 100 individual codes**
- **KOMTRAX Plus[®], for immediate diagnostics of machine health and performance** **NEW**
- **Wireless LAN communication, for near real-time transmission of machine data**
- **Fleet Management via KOMTRAX[®] Plus and/or available integration with 3rd party telematics systems** **UPGRADE**

*All comparisons are to prior model in power mode, unless otherwise stated.

PERFORMANCE FEATURES

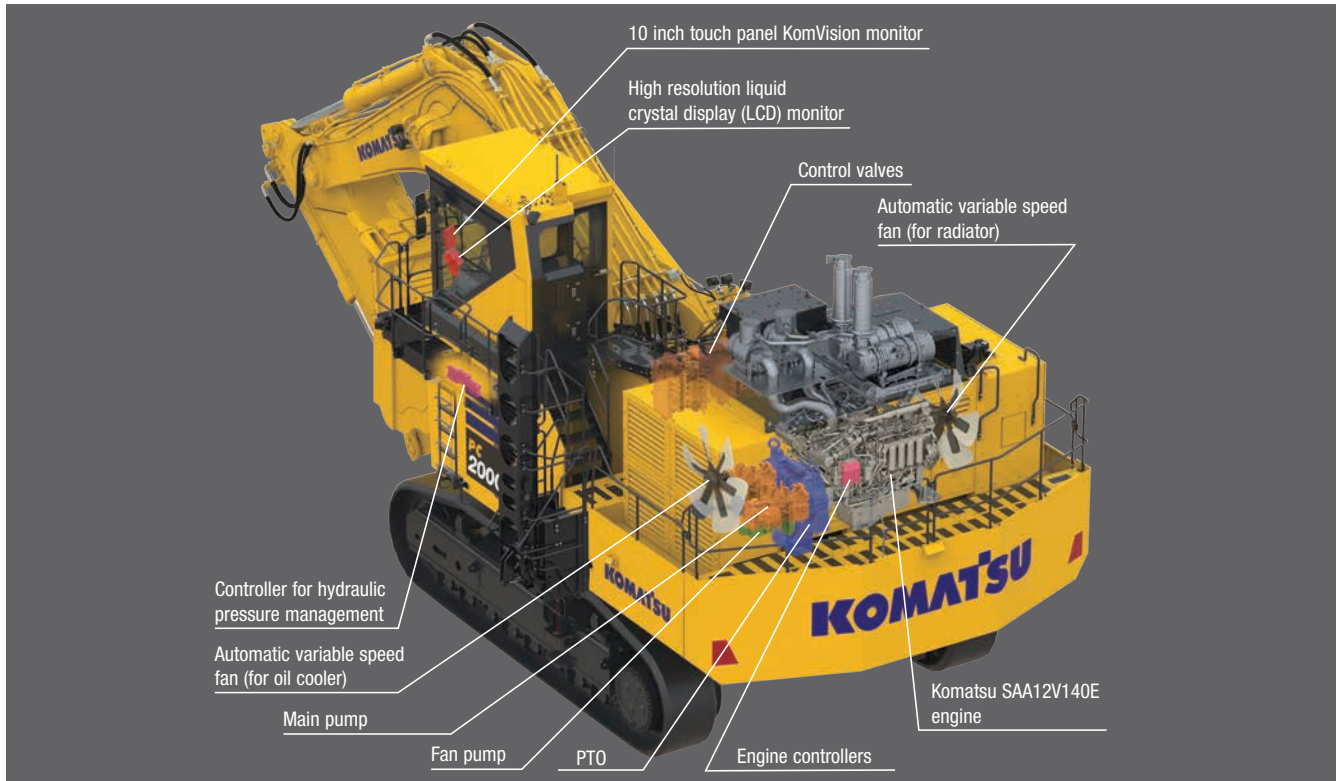

Powerful and Fuel Efficient

PC2000-11 is equipped with the new Komatsu SAA12V140E-7 engine that features clean, fuel efficient and powerful performance. The hydraulic system was designed to be more efficient and in combination with an on-demand power control system, fuel efficiency is significantly improved. Production costs are reduced and the PC2000-11 moves more material per unit of fuel. PC2000-11 is a new generation of Powerful, Clean and Economical machines.

Selectable Working Modes

The PC2000-11 features four different working modes to cater machine performance to application demands and working conditions. Working mode options of Power Plus (P+), Power (P), and two Economy modes (E0 and E1) can be selected using a shortcut button on the machine monitor. With the selectable working modes, operators can ensure that the machine is working to deliver the best combination of productivity and fuel efficiency.

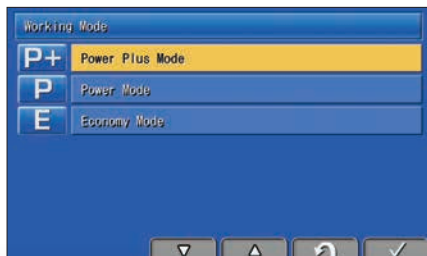

High Productivity with Power Plus Mode

The introduction of the new Power Plus (P+) mode yields productivity gains of 12%.

P+ mode productivity

increased by **12%**

VS PC2000-8 P mode (90° swing and loading onto truck)

P mode fuel efficiency

increased by **7%**

VS PC2000-8 P mode (90° swing and loading onto truck)

E0 mode fuel consumption

Reduced by up to **8%**

VS PC2000-8 P mode (90° swing and loading onto truck)

This fuel consumption data is the result of using a prototype

PC2000-11

Shockless Boom Control

The PC2000-11 boom circuit features a double-check slow return valve that provides a boom cylinder cushion to improve operator comfort, reduce shock and reduce material spillage during the loading process.

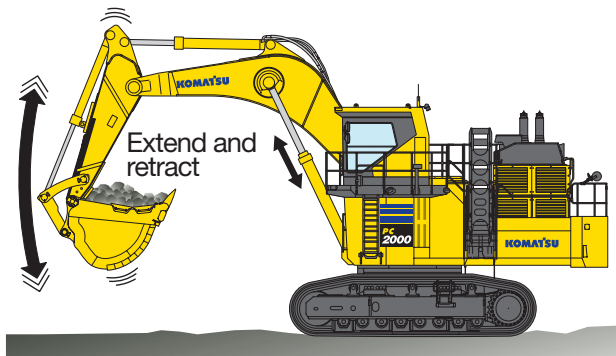

Multiple Boom Settings

Smooth mode is designed for gathering blasted rock or during scraping operations. When maximum digging force is needed, switch to Power mode for more effective excavating.

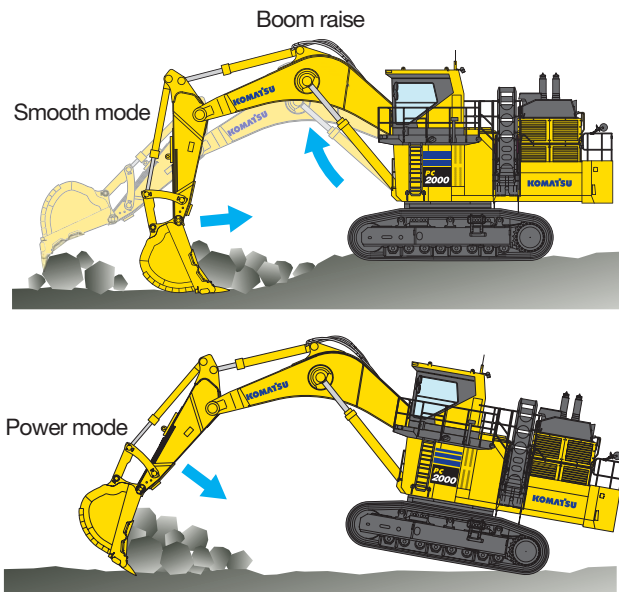

The PC2000-11 features four different working modes to cater machine performance to application demands and working conditions. Working mode options of Power Plus (P+), Power (P), and two Economy modes (E0 and E1) can be selected using a shortcut button on the machine monitor. With the selectable working modes, operators can ensure that the machine is working to deliver the best combination of productivity and fuel efficiency.

Heavy Lift Mode

Turning the heavy lift mode switch on activates the all-out power delivery system to increase the lifting force of the boom by 10%. This is beneficial when handling rock and during heavy lifting applications.

Optimized Electrical Valve Control Improvement of work equipment speed

Digging speed is improved by reduction of hydraulic loss when arm digging.



Improvement of operability

Optimized spool control by electronic pilot control provides smoother compound movement.

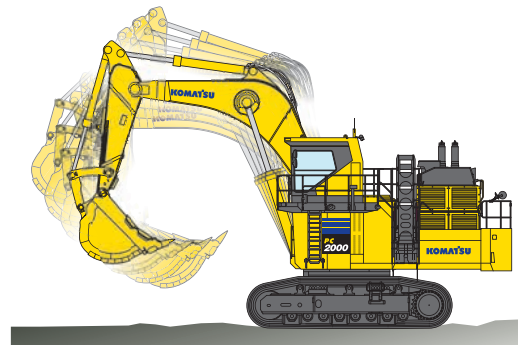

Swing Priority Mode Settings

Swing Priority mode increases boom raise speed in small swing angle applications or increases swing speed in large swing angle applications to reduce cycle times. By altering the oil flow priority, this setting sets either boom or swing as the priority for increased production.

PERFORMANCE FEATURES

KOMATSU NEW ENGINE TECHNOLOGIES

Komatsu's New Emission Regulations-compliant Engine

Komatsu provides a powerful and economical U.S. EPA Tier 4 Final compliant engine with latest emission control technologies and fuel saving features.

New Engine Technology

Heavy-duty aftertreatment system

Komatsu Diesel Particulate Filter (KDPF) reduces Particulate Matter (PM) by more than 80% when compared to Tier 2 levels. Special oxidation catalyst and extra fuel injection in the exhaust stream can decompose accumulated soot in the KDPF filter by either active or passive regeneration. This system does not require any additional operator's action or interrupt normal operation.

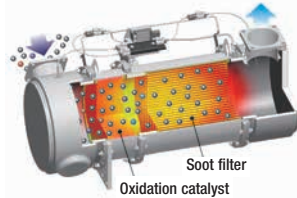

Heavy-duty cooled Exhaust Gas Recirculation (EGR)

The system recirculates a portion of exhaust gas into air intake and lowers combustion temperatures, thereby reducing NOx emissions. Furthermore, while EGR gas flow is increased, by incorporating a high-efficiency and compactly designed cooling system, the system achieves a dynamic reduction of NOx, while helping reduce fuel consumption.

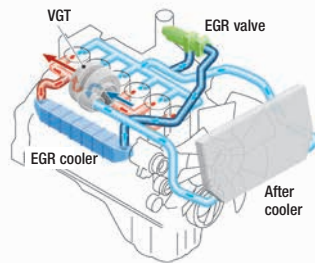

High Pressure Common Rail (HPCR) fuel injection

The system is designed to achieve an optimal injection of high-pressure fuel by means of computerized control, thereby bringing close to complete combustion to reduce Particulate Matter (PM) emissions.

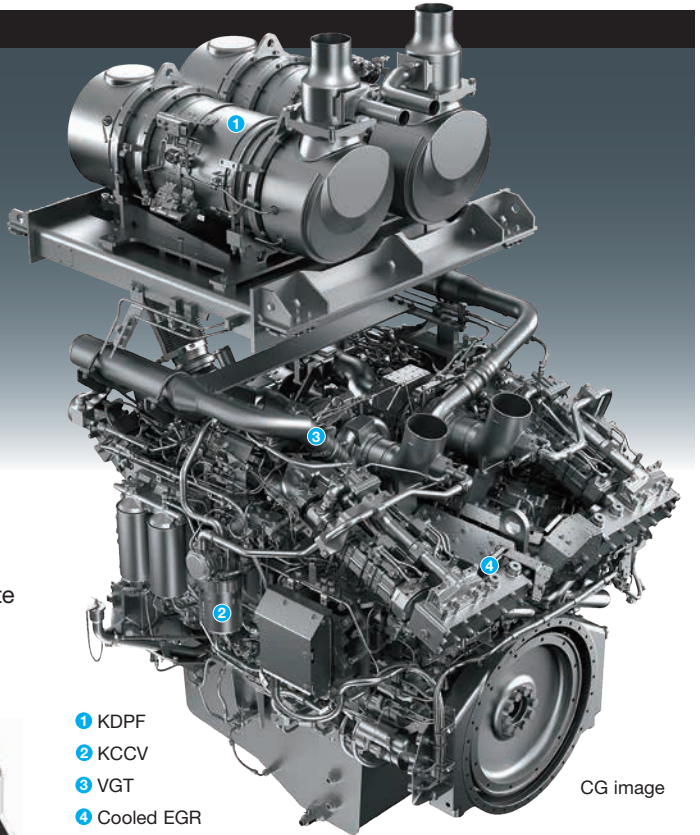
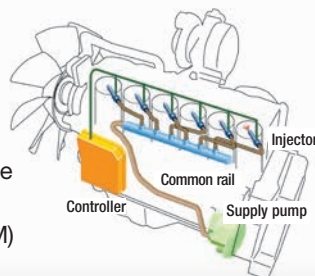

- 1 KDPF
- 2 KCCV
- 3 VGT
- 4 Cooled EGR

Variable Geometry Turbocharger (VGT)

The VGT system features Komatsu design hydraulic technology for variable control of air-flow and supplies optimal air according to load conditions. The upgraded version realizes better exhaust temperature management.

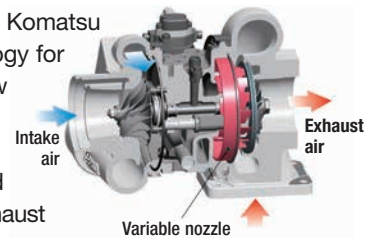

Komatsu Closed Crankcase Ventilation (KCCV)

Crankcase emissions (blow-by gas) are passed through a KCCV filter. The oil mist trapped in the filter is returned back to the crankcase while the filtered gas is returned to the air intake.

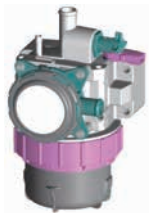

Electronic control system

Conditions of the engine are displayed via an on-board network on the monitor inside the cab. Furthermore, managing the information via KOMTRAX Plus® helps customers engage in appropriate maintenance.

Optimization of Environmental and Operational Efficiencies

Ecology guidance

While the machine is in operation, the monitor panel provides guidance to the operator to help promote efficient machine operation.

Ecology & fuel consumption gauge

The monitor screen is equipped with an ecology gauge and a fuel consumption gauge representative of momentary fuel rate. The operator can set a fuel consumption target (within the range of the green display), enabling the machine to be operated more efficiently.



Operation record, fuel consumption history, and Ecology guidance record.

The Ecology guidance menu enables the operator to check the operation record, fuel consumption history and Ecology guidance record from the Ecology guidance menu, with a single touch, thus assisting operators with reducing total fuel consumption.

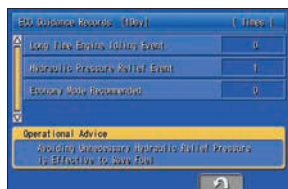

Ecology guidance record



Operation record



Fuel consumption history

Auto idle shutdown (Adjustable)

When the engine has been idling for an operator defined interval, the engine stops automatically to reduce unnecessary fuel consumption and exhaust emissions. The duration before the engine shutdown can be easily programmed.

Auto deceleration and auto idling system

The PC2000-11 is equipped with an auto deceleration system that reduces the engine speed to 1400 rpm after four continuous seconds with no operator inputs to the work equipment controls. When enabled, the auto idling system can further reduce engine speed after an additional 30 seconds with no input to the work equipment controls.

Power Module for Low Ambient Noise Levels

Noise sources such as the engine, cooling fan, and hydraulic pumps are packaged within the power module. Large sound absorbing blades attached to the air intake and exhaust outlet block noise transmission. This sound suppression in combination with the hydraulically-driven, variable speed cooling fans with unique "hybrid" blade geometry help the PC2000-11 to achieve extremely low ambient noise levels.



RELIABILITY

POWER MODULE

Reduced Inspection/ maintenance and Overhaul Man-hours contribute to lower the Total Cost of Ownership.

Power Module Packaging

Engine, radiator, oil cooler, hydraulic pumps and PTO are packaged within the power module. This design facilitates installation and removal of components, contributing to the reduction of maintenance transportation and overhaul hours.

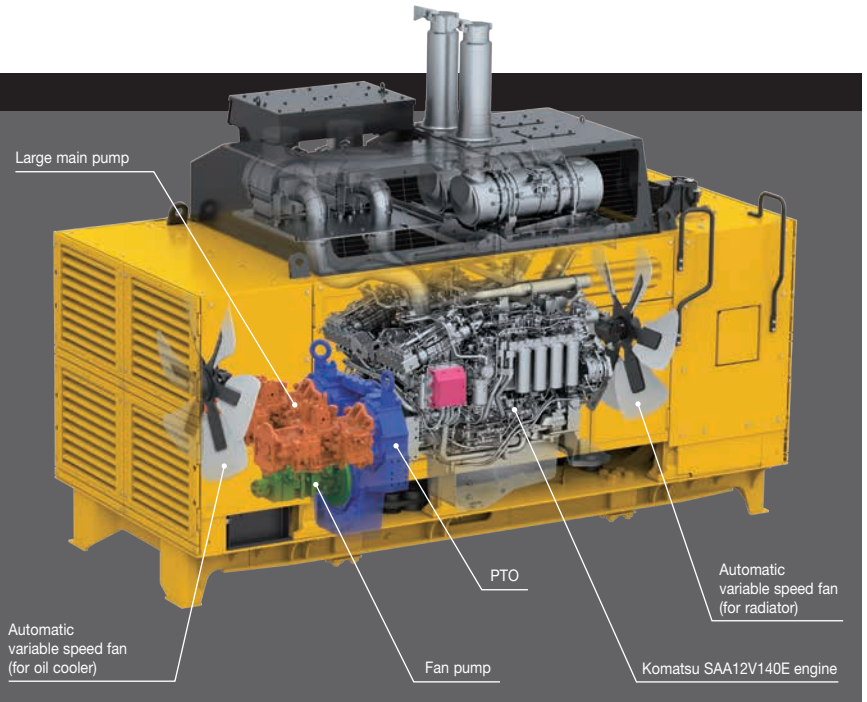

Simplified construction and component layout facilitates maintenance and inspections.

The use of a single-engine, the location and orientation of hydraulic pumps and simplified hydraulic circuit enables reduced hours required for inspection and maintenance.

High cooling efficiency

Increased oil cooler capacity lowers the heat balance temperature of hydraulic oil to realize lower operating temperatures. Heat-resistant rubber seals are used in hydraulic pumps and cylinders to achieve high durability of components. These improvements dramatically extend the service life of the hydraulic system.

Durable Swing Circle with Triple-roller Bearing

Large capacity triple-roller bearing is used for the swing circle. The swing circle exhibits excellent durability despite the high loads created during heavy excavation.

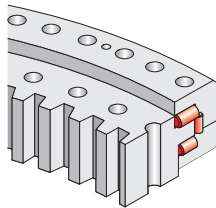

Strengthened Frame Structure

Revolving frame, center frame and crawler frame have been strengthened to exhibit excellent durability in the most challenging applications.

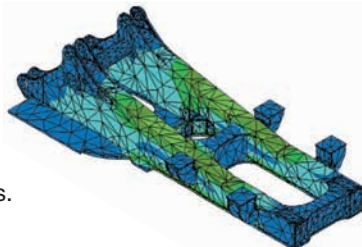

Strengthened Boom

Thanks to the integration of newly designed side plates and the shape change of the boom's top casting, the boom exhibits excellent durability and is highly resistant to bending and torsional stress.

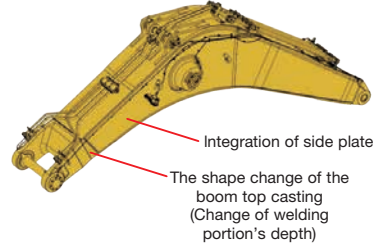

Rock Protector Guards

Arm rock protector is equipped as standard. The protector guards the arm greasing piping against impact.



Arm rock protector

Wear-resistant Floating Pin

Boom top pin and arm top pin are floating type. Since the pin can freely rotate, it receives less friction load and exhibits excellent reliability and durability.

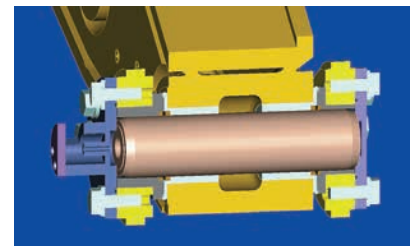

Double Sealing Structure for Hydraulic Cylinders

With the additional scraper and a sub dust seal, the work equipment cylinders can prevent dust entry and keep the hydraulic system free of contamination, extending the service interval of the work equipment cylinders.

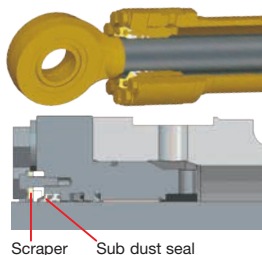

Extended Life Carrier Rollers

Larger diameter carrier rollers for extended service life and lower maintenance costs. Extending the service interval aligns replacement schedule with that of other undercarriage components.

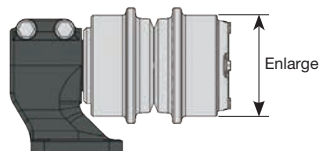

Travel Motor Guards

Travel motors are shielded by sturdy guards. They prevent the motors from being damaged by the thrust of rocks.



Photos may include optional equipment.

ACCESSIBILITY

Operator Cab Specially Designed for Mining

Operator cab provides a comfortable working environment. Sturdy cab of solid construction, with top guard conforms to OPG level 2 (ISO 10262).



45° Access Stairway

The machine is equipped with a hydraulic operated stairway. All stairways of this machine are 45° so that operators can easily access the cab from ground-level.



45° access hydraulically operated stairway

Seat Belt Caution Indicator

Visible on the monitor panel when operator seat belt is not fastened.



Lock Lever Auto Lock Function

If the work equipment lever is not in the neutral position when the hydraulic lock lever is released, the equipment is automatically stopped. The auto stop state is shown on the monitor screen.

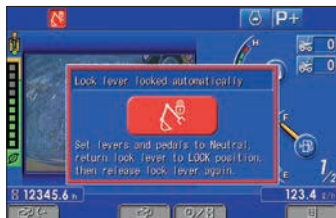

Secondary Engine Shutdown

Equipped at the console to shutdown the engine.



Emergency Engine Stop Device & Fuel Cut-off Lever

North American standard equipment includes five emergency stop devices. Emergency stop devices are located in the cabin (1), on the power module (2), on the boarding ladder (1), and beneath the revolving frame (1). In addition, a fuel cut-off lever on the revolving frame stops the engine from the ground.

Emergency engine stop switch



Fuel cut-off lever

Emergency engine stop switch

Accessibility Equipment

Slip-resistant plates



LED working light (Optional) (2 lamps)



Interconnected horn and flashing light

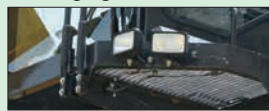

Rope ladder for emergency egress



Lock lever

Dual rearview mirror

Wide catwalk with handrail

Hammer for emergency escape

Fire extinguisher (Optional)

Travel alarm

Seat belt retractable

Beacon

OPERATOR ENVIRONMENT

COMFORTABLE WORKING SPACE

Excellent Operational Visibility

Visibility around the machine is improved by integrating the console. Large cab designed for exclusive use in mining shovels.



Low Noise and Low Vibration with Cab Damper Mounting

Integrated structure of cab and damper mounts, in combination with power module packaging, contribute to low vibration and noise levels (*dynamic noise levels of 64.1 dB(A) in the cab*).

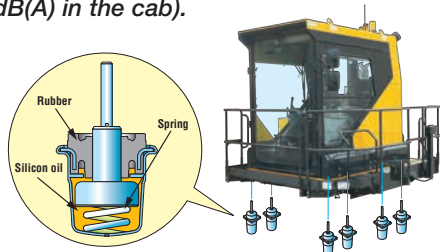

Spacious and Comfortable Cab Design Pressurized Cab

The large operator's cabin is designed exclusively for use in mining shovels. The improved, air-tight cabin is pressurized to prevent dust intrusion. A redesigned twin air conditioning system efficiently cools and heats the cab to keep operators comfortable in the most challenging environments.

Comfortable Air Suspension Seat with Heater

The seat with air suspension minimizes and softens vibrations transmitted to the operator. Depending on the operator's weight and physique, the cushion can be adjusted and the seat can slide fore/aft and vertically. The work equipment control consoles are integrated into the seat suspension for additional operator comfort and to reduce fatigue.

Standard Equipment



- 1 Cup holder
- 2 Air conditioner control panel
- 3 Cigarette lighter (24 V)
- 4 2 x 12 V socket
- 5 Magazine box
- 6 Handling radio
- 7 Ashtray
- 8 Auxiliary input jack

Trainer's seat diagonally behind the operator



Floor mat

Dual rear view mirror



High back air suspension seat with heater

Sun shield

Defroster (Conform to ISO 10263-5)

LED room light

Sliding window glass (left side)

Utility box

Large twin wiper

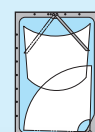

OPERATOR ENVIRONMENT

LARGE HIGH RESOLUTION LIQUID CRYSTAL DISPLAY (LCD) MONITOR



Machine Monitor

The interface has been redesigned to enable the necessary information to be read and understood more easily, while retaining the maneuverability of previous model. A rear view camera image has been added to the default main screen. The interface has a function that allows the main screen to be switched, therefore operators will have visibility to the most appropriate data for the task at hand.



Indicators

- | | | |
|----------------------------|------------------------------------|------------------------------|
| 1 Auto-decelerator | 7 Engine coolant temperature gauge | 12 Engine oil pressure gauge |
| 2 Working mode | 8 Hydraulic oil temperature gauge | 13 Service meter / Clock |
| 3 Camera direction display | 9 Fuel gauge | 14 Fuel consumption gauge |
| 4 Camera display | 10 PTO oil temperature gauge | 15 Guidance icon |
| 5 Truck counter | 11 Engine oil temperature gauge | 16 Function switches |
| 6 ECO gauge | | |

Basic operation switches

- | | | |
|-------------------------|-----------------|-----------------|
| 1 Auto-decelerator | 3 Heavy lift | 5 Wiper |
| 2 Working mode selector | 4 Buzzer cancel | 6 Window washer |

Operator's Menu

Pressing the F6 key (shortcut) on the main screen displays the user menu screen. The menus, data, and selectable options are grouped based on functionality, and easy-to-understand icons are intuitive for users.



- 1 Energy saving 2 Machine settings
- 3 Aftertreatment devices regeneration 4 Maintenance
- 5 Monitor setting 6 Mail check

Switchable Main Screen

The main display can be cycled by pressing the F3 key.

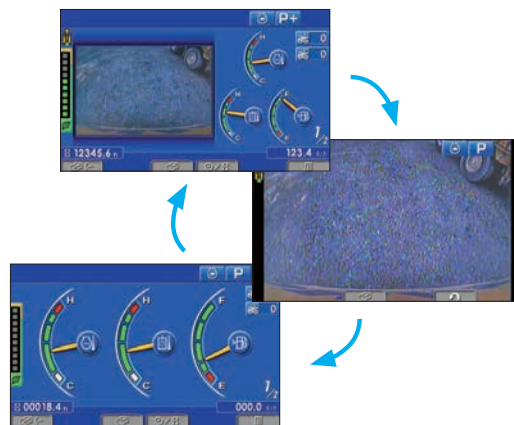

Operator Identification Function

An operator identification ID can be set for each operator, and used to manage operation information using KOMTRAX Plus® data. Data sent from KOMTRAX Plus® can be used to analyze operation status by operator as well as by machine.

10 INCH TOUCH PANEL KOMVISION MONITOR



- Indicators**
- ① System status lamp
 - ② Camera display
 - ③ Camera direction display
 - ④ Menu icon

KomVison, All Round Monitoring System

KomVison is included as standard equipment and is a seven-camera system that provides the operator with a bird's eye view of the machine and surrounding working area. This system improves situational awareness on the jobsite.

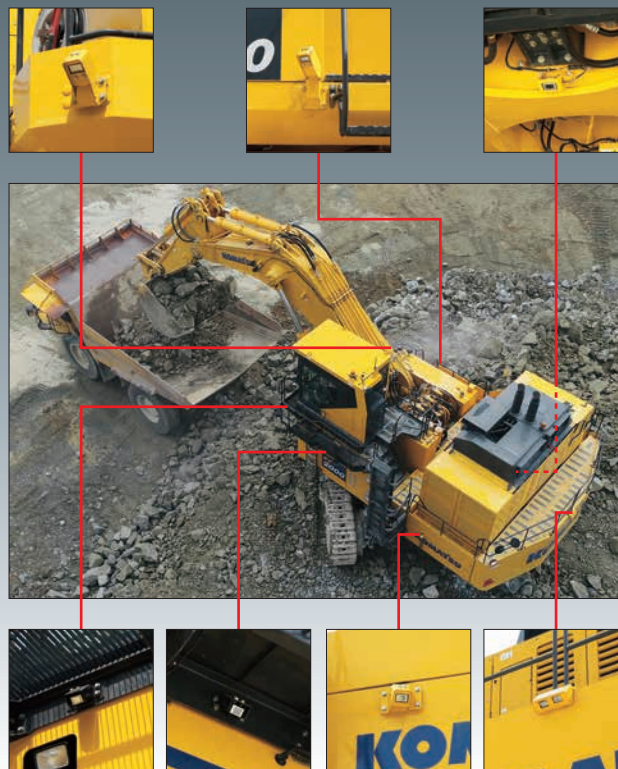

KOMTRAX Plus®

KOMTRAX Plus

Assists Customer's Equipment Management and Contributes to Efficient Operation

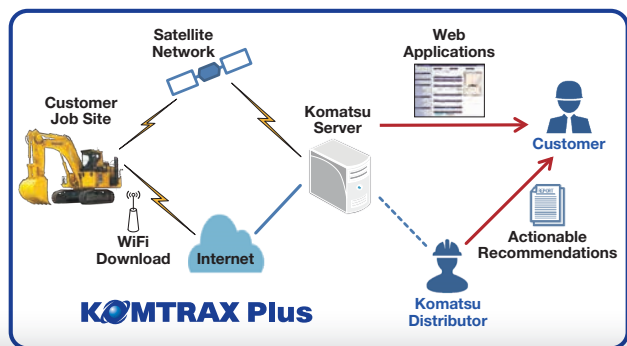

Equipment Management Support

KOMTRAX Plus® enables expanded monitoring of the fleet via satellite and wireless LAN. Users can analyze "machine health" and performance from a remote location, on a near-real time basis. This includes component condition and trend data. By making this critical information readily accessible, KOMTRAX Plus® is an effective tool in maximizing productivity and lowering operating costs



MAINTENANCE FEATURES

Advanced Layout for Facilitating Inspection and Maintenance

Catwalk surrounding the power module and center walkway provides easy access to the inspection and maintenance points.

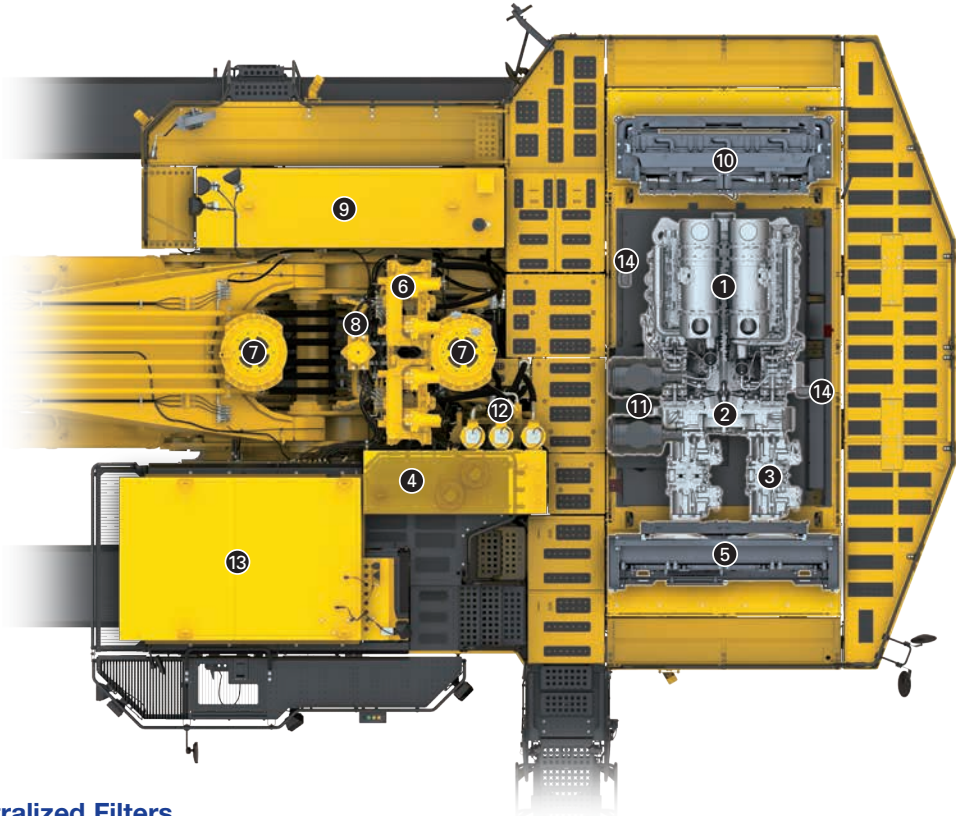

- ❶ Engine
- ❷ PTO
- ❸ Hydraulic pump
- ❹ Hydraulic tank
- ❺ Oil cooler
- ❻ Control valve
- ❼ Swing motor
- ❽ Swivel joint
- ❾ Fuel tank
- ❿ Radiator
- ⓫ Air cleaner
- ⓬ Hydraulic oil filter
- ⓭ Cab
- ⓮ Maintenance light

Centralized Filters

Centralized filters contribute to easy maintenance.

Ground-level, Remote Service

Remote drain piping provided for hydraulic oil, PTO oil, engine oil and coolant enable ground-level service.

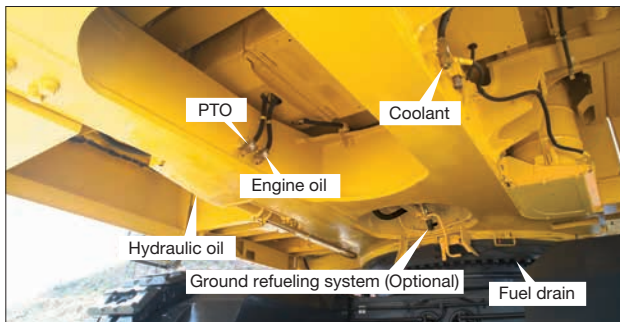

Service Center

Collective arrangement of drain and filler ports for fuel, oil, grease and coolant on the service center, which is hydraulically actuated up and down, enable ground-level service.



Automatic Greasing System

Greasing work equipment and bucket is fully automated. Since the system carries out automatic greasing at regular time intervals, greasing is hassle-free.

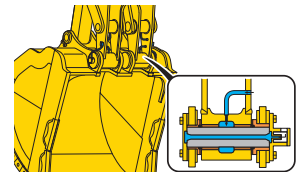

Large Fuel Tank

900 gallon large fuel tank enables continuous operation for 24 hours.

Large Capacity Grease Tank with Remote Fill

The machine is equipped with a 50 gallon, large capacity grease tank to perform 24 hours of operation. A remote fill allows the grease tank to be serviced from ground-level.



Access Light with Timer and Maintenance Light

An access light with timer provides light for 90 seconds to allow the operator to get off the machine. This light can be used as a continuous maintenance light.



Battery Isolator and Starting Motor Isolator

During inspection and maintenance or long-term storage, the isolators serve to isolate both positive and negative terminals of the battery and starting motor.



Jump Start Receptacle

Jump start receptacle allows starting engine from external power source.

Reversible Cooling Fans

The hydraulically driven fan can be reversed to facilitate cleaning of the cooling unit. In addition, this feature contributes to reducing warm-up time in low temperatures.

Easy Maintenance of Air Conditioner Units

Enlarged unit space, easy to check and exchange air conditioner units.



Long-life Filters

Hydraulic oil and fuel filter service intervals of 1,000 hours.



Hydraulic filter

Fuel Pre-filter (with Water Separator)

Removes water and contaminants from fuel to enhance the fuel system reliability.



Hydraulic Return Filter Restriction Detection

Recommends filter exchange and prevents catastrophic damage of hydraulic system by informing operator the restriction of hydraulic return filter. The signal can be monitored via the KOMTRAX Plus®.



Monitor Function

Controller monitors engine oil level, coolant temperature, battery charge and intake restriction, etc. If controller senses any abnormality. It is displayed on the LCD.

Abnormality Memory Function

Monitor stores abnormalities for effective troubleshooting.



Maintenance Information

“Maintenance time caution lamp” display

When the remaining time to maintenance becomes less than 30 hours*, the maintenance time monitor appears. Pressing the F6 key switches the monitor to the maintenance screen.

* The setting can be changed within the range between 10 and 200 hours.

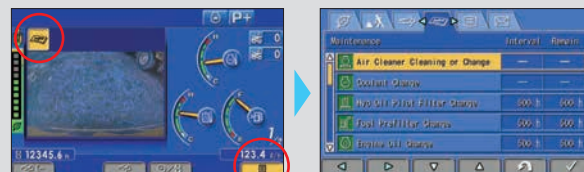

Maintenance screen

Aftertreatment devices regeneration automatic display

When it is necessary to carry out manual regeneration (the manual stationary regeneration) of the KDPF, the display automatically switches to the aftertreatment device regeneration screen to inform the operator.

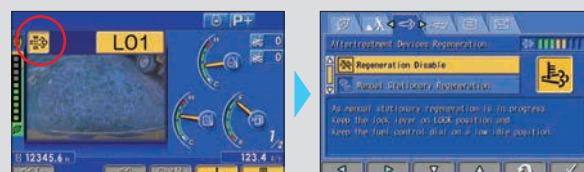

Aftertreatment device regeneration screen

SPECIFICATIONS



ENGINE

Model..... Komatsu SAA12V140E-7*
 Type..... Water-cooled, 4-cycle, direct injection
 Aspiration..... Turbocharged, aftercooled, cooled, EGR
 Number of cylinders..... 12
 Bore..... 140 mm **5.51"**
 Stroke..... 165 mm **6.50"**
 Piston displacement..... 30.48 ltr **1860 in³**
 Governor..... All-speed, electronic
 Horsepower:
 SAE J1995..... Gross 794 kW **1065 HP**
 ISO 9249 / SAE J1349..... Net 780 kW **1046 HP**
 Rated rpm..... 1800
 Fan drive method for radiator cooling..... Hydraulic

*EPA Tier 4 Final emissions certified



HYDRAULICS

Type..... Open-center load sensing system,
 3 selectable working modes
 Main pump:
 Type..... Variable capacity piston pumps
 Pumps for..... Boom, arm, bucket, swing, and travel circuits
 Maximum flow for attachment, swing and travel.... 2317 ltr/min
612 gal/min
 Maximum flow for fan drive..... 324 ltr/min **85.6 gal/min**
 Hydraulic motors:
 Travel..... 2 x axial piston motors with parking brake
 Swing..... 2 x axial piston motors with swing holding brake
 Relief valve setting:
 Attachment circuits
 Backhoe..... 29.4 MPa 300 kgf/cm² **4,270 psi**
 Travel circuit..... 32.9 MPa 335 kgf/cm² **4,760 psi**
 Swing circuit..... 29.4 MPa 300 kgf/cm² **4,270 psi**
 Pilot circuit..... 3.2 MPa 33 kgf/cm² **464 psi**
 Hydraulic cylinders:
 (Number of cylinders – bore x stroke)
 Backhoe
 Boom..... 2–300 mm x 2647 mm **11.8" x 104.2"**
 Arm..... 2–250 mm x 2134 mm **9.8" x 84.2"**
 Bucket..... 2–200 mm x 2170 mm **7.9" x 85.4"**



DRIVE SYSTEM

Travel gear..... Two levers with pedals
 Gradeability..... 70%, 35°
 Maximum travel speed..... 2.7 km/h **1.7 mph**
 Parking brakes..... Oil disc brakes



SWING SYSTEM

Swing gear..... 2 x Planetary gear
 Swing circle lubrication..... Grease-bathed
 Swing holding brakes..... Oil disc brakes
 Swing speed..... 4.8 rpm



UNDERCARRIAGE

Track adjuster..... Grease
 Number of shoes (each side)..... 49
 Number of carrier rollers (each side)..... 3
 Number of track rollers (each side)..... 8



COOLANT & LUBRICANT CAPACITY (REFILLING)

Fuel tank..... 3400 ltr **898.2 U.S. gal**
 Radiator..... 240 ltr **63.4 U.S. gal**
 Engine..... 128 ltr **33.8 U.S. gal**
 Travel gear, each side..... 85 ltr **22.5 U.S. gal**
 Swing drives..... 2 x 30 ltr **2 x 7.9 U.S. gal**
 Hydraulic tank..... 1300 ltr **343.4 U.S. gal**
 Power Take Off (PTO)..... 40 ltr **10.6 U.S. gal**



OPERATING WEIGHT (APPROXIMATE)

Backhoe:
 Operating weight, including 8700 mm **28'7"** boom, 3900 mm **12'10"** arm, SAE J 296 heaped 12.0 m³ **15.7 yd³** general purpose backhoe bucket lubricant, coolant, full fuel tank, and the standard equipment.

Shoes	PC2000-11	
	Operating Weight	Ground Pressure (ISO 16754)
Double grouser	201930 kg	1.96 kg/cm ²
810 mm 32"	445,054 lb	27.9 psi
Triple grouser	206050 kg	1.60 kg/cm ²
1010 mm 40"	454,134 lb	22.8 psi

PC2000-11



DIMENSIONS

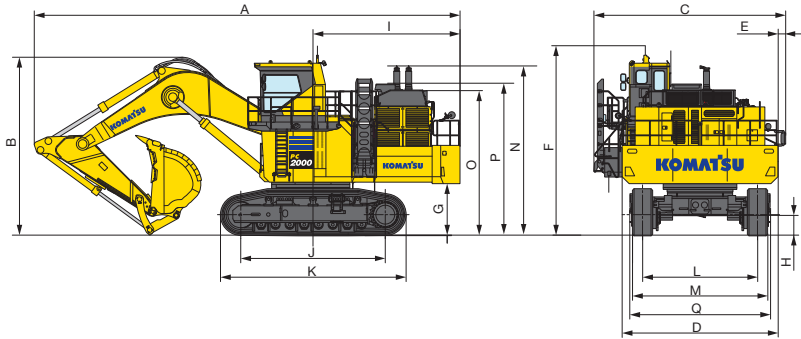

	PC2000-11	
Boom Length	8.7m	28'7"
Arm Length	3.9m	12'10"
A Overall Length	17030mm	55'10"
B Overall Height to top of boom	7135mm	23'5"
C Overall width (walkway installed)	7685mm	25'6"
D Upper width (L/R walkways walkway removed)	6240mm	20'7"
E Width of R walkway	310mm	1'0"
F Overall height to top of cab	7625mm	25'0"
G Ground clearance, counterweight	2095mm	6'10"
H Ground clearance, minimum	825mm	2'8"
I Tail swing radius	5980mm	19'7"
J Track length on ground	5780mm	18'11"
K Track length	7445mm	24'5"
L Track gauge	4600mm	15'1"
M Width over crawler	5410mm	17'9"
N Height to Exhaust Stack	6825mm	22'5"
O Height to rear walkway	4635mm	15'2"
P Height to top of engine hood	5855mm	19'3"
Q Undercarriage width	5650mm	18'6"



WORKING RANGE

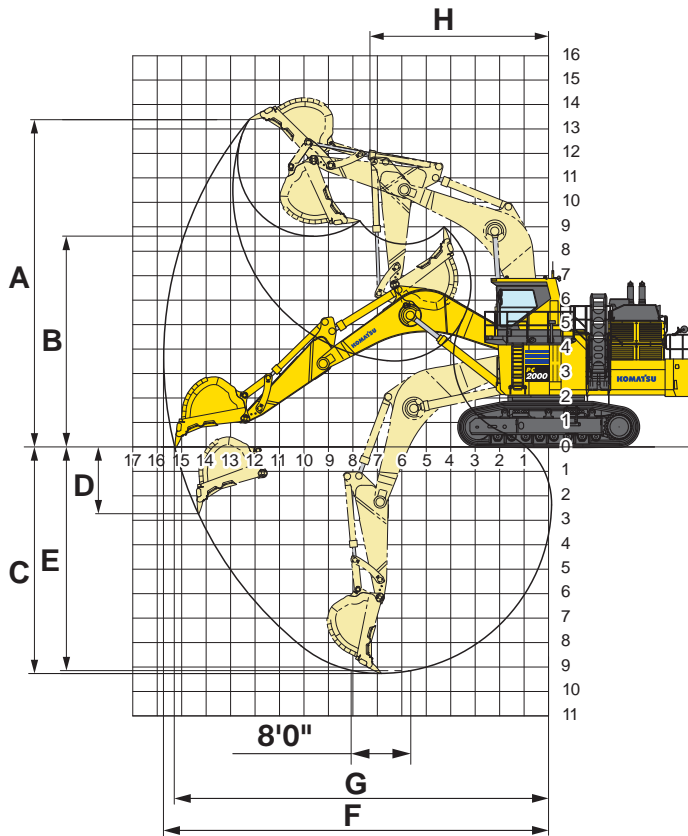

	Boom Length	8.7 m	28'7"
	Arm Length	3.9 m	12'10"
A Max. digging height		13410 mm	44'0"
B Max. dumping height		8650 mm	28'5"
C Max. digging depth		9235 mm	30'4"
D Max. vertical wall digging depth		2710 mm	8'11"
E Max. digging depth for 8'level bottom		9115 mm	29'11"
F Max. digging reach		15780 mm	51'9"
G Max. digging reach at ground level		15305 mm	50'3"
H Min. swing radius		7500 mm	24'7"
SAE rating	Bucket digging force at power max. (SAE J 1179)	626 kN	63800 kg / 140,655 lb
	Arm crowd force at power max. (SAE J 1179)	586 kN	59700 kg / 131,616 lb
	Bucket digging force at power max. (ISO 6015)	697 kN	71100 kg / 156,749 lb
ISO rating	Arm crowd force at power max. (ISO 6015)	598 kN	61000 kg / 134,482 lb



BACKHOE BUCKET REFERENCE CHART

	General Purpose Bucket		Standard Rock Bucket		Heavy Rock Bucket		Iron Ore Bucket	
	Imperial	Metric	Imperial	Metric	Imperial	Metric	Imperial	Metric
Heaped Capacity ISO 7451 (@ 1:1)	17.9 yd ³	13.7 m ³	15.7 yd ³	12 m ³	14.9 yd ³	11.4 m ³	12.0 yd ³	9.1 m ³
Bucket Payload	24.6 tons	22.3 tonnes	23.6 tons	21.4 tonnes	24.3 tons	22.0 tonnes	26 tons	23.6 tonnes
Bucket Weight	26,750 lbs	12134 kg	28,800 lbs	13063 kg	27,500 lbs	12474 kg	24,000 lbs	10886 kg
Material Density (loose)	2,750 lbs/yd ³	1.63 tonnes/m ³	3,000 lbs/yd ³	1.78 tonnes/m ³	3,250 lbs/yd ³	1.93 tonnes/m ³	4,350 lbs/yd ³	2.58 tonnes/m ³
Bucket Width Outer, without side shrouds	107 in	2720 mm	102 in	2600 mm	102 in	2600 mm	102 in	2600 mm

Note: The above chart is a guideline for bucket selection and may not represent all applications. Bucket sizes, weights, and widths will vary depending on material, fragmentation, or other digging conditions.

LIFT CAPACITIES

kg

LIFTING CAPACITY WITH LIFTING MODE

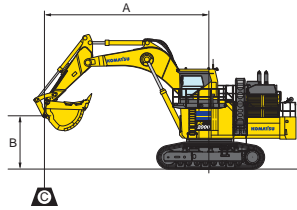

PC2000-11

Equipment:

- Boom: 28' 7" 8.7 m
- Arm: 12' 9" 3.9 m
- Bucket: 15.7 yd³ 12.0 m³
- Bucket weight: 21,385 lb 9700 kg
- Track shoe width: 31.8" 810 mm

- A: Reach from swing center
- B: Bucket hook height
- C: Lifting capacity
- Cf: Rating over front
- Cs: Rating over side
- ⊗: Rating at maximum reach

Heavy Lift: Off		Arm: 12' 9" 3.8 m				Bucket: 15.7 yd ³ 12.0 m ³				Shoes: 32" 810 m		Unit: kg lb			
B	A	3.0 m 10'		4.6 m 15'		6.1 m 20'		7.6 m 25'		9.1 m 30'		10.7 m 35'		MAX	⊗
		Cf	Cs	Cf	Cs	Cf	Cs	Cf	Cs	Cf	Cs	Cf	Cs	Cf	Cs
7.6 m	25'											*31260	*31260	*21090	*21090
												*68916	*68916	*46495	*46495
6.1 m	20'							*46650	*46650	*38660	*38660	*33080	*33080	*21970	*21970
								*102846	*102846	*85231	*85231	*72929	*72929	*48436	*48436
4.6 m	15'							*51990	*51990	*41920	*41920	*35010	*35010	*23380	*23380
								*114618	*114618	*92418	*92418	*77184	*77184	*51544	*51544
3.0 m	10'							*56490	*56490	*44870	*44870	*36810	35990	*25580	24200
								*124539	*124539	*98921	*98921	*81152	79344	*56394	53352
1.5 m	5'					*61340	*61340	*58810	*58810	*46620	45420	*37870	34570	*28540	24240
						*135231	*135231	*129654	*129654	*102779	100134	*83489	76214	*62920	53440
0 m	0'					*62440	*62440	*59070	59060	*47050	43940	*37980	33550	*29510	25110
						*137656	*137656	*130227	130205	*103727	96871	*83731	73965	*65058	55358
-1.5 m	-5'	*33170	*33170	*48950	*48950	*62960	*62960	*57220	*57220	*45860	43170	*36720	33030	*29900	27030
		*73127	*73127	*107916	*107916	*138803	*138803	*126148	*126148	*101104	95173	*80954	72819	*65918	59591
-3.0 m	-10'	*49290	*49290	*61520	*61520	*64600	*64600	*53060	*53060	*42610	*42610	*33320	33100	*30010	*30010
		*108666	*108666	*135628	*135628	*142418	*142418	*116977	*116977	*93939	*93939	*73458	72973	*66161	*66161
-4.6 m	-15'	*62010	*62010	*62290	*62290	*56230	*56230	*45270	*45270	*35680	*35680			*29310	*29310
		*136708	*136708	*137326	*137326	*123966	*123966	*99803	*99803	*78661	*78661			*64617	*64617
-6.1 m	-20'			*49660	*49660	*41470	*41470	*32720	*32720					*26520	*26520
				*109481	*109481	*91426	*91426	*72135	*72135					*58467	*58467

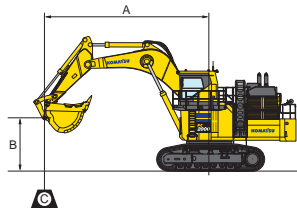

PC2000-11

Equipment:

- Boom: 28' 7" 8.7 m
- Arm: 12' 9" 3.9 m
- Bucket: 15.7 yd³ 12.0 m³
- Bucket weight: 21,385 lb 9700 kg
- Track shoe width: 31.8" 810 mm

- A: Reach from swing center
- B: Bucket hook height
- C: Lifting capacity
- Cf: Rating over front
- Cs: Rating over side
- ⊗: Rating at maximum reach

Heavy Lift: On		Arm: 12' 9" 3.8 m				Bucket: 15.7 yd ³ 12.0 m ³				Shoes: 32" 810 m		Unit: kg lb			
B	A	3.0 m 10'		4.6 m 15'		6.1 m 20'		7.6 m 25'		9.1 m 30'		10.7 m 35'		MAX	⊗
		Cf	Cs	Cf	Cs	Cf	Cs	Cf	Cs	Cf	Cs	Cf	Cs	Cf	Cs
7.6 m	25'											*35600	*35600	*23720	*23720
												*78484	*78484	*52294	*52294
6.1 m	20'							*52480	*52480	*43760	*43760	*37690	*37690	*24670	*24670
								*115698	*115698	*96474	*96474	*83092	*83092	*54388	*54388
4.6 m	15'							*58610	*58610	*47510	*47510	*39920	37780	*26190	24970
								*129213	*129213	*104741	*104741	*88008	83291	*57739	55049
3.0 m	10'							*63820	*63820	*50920	47590	*42010	35990	*28570	24200
								*140699	*140699	*112259	104918	*92616	79344	*62986	53352
1.5 m	5'					*62870	*62870	*66550	60950	*52980	45420	*43270	34570	*31770	24240
						*138604	*138604	*146717	134372	*116801	100134	*95394	76214	*70041	53440
0 m	0'					*62440	*62440	*66960	59060	*53560	43940	*43470	33550	*34090	25110
						*137656	*137656	*147621	130205	*118079	96871	*95835	73965	*75155	55358
-1.5 m	-5'	*36810	*36810	*48220	*53920	*62960	*62960	*65020	58240	*52320	43170	*42140	33030	*34580	27030
		*81152	*81152	*106307	*118873	*138803	*138803	*143344	128397	*115346	95173	*92903	72819	*76236	59591
-3.0 m	-10'	*54280	*54280	*61520	*61520	*64600	*64600	*60510	58310	*48800	43110	*38450	33100	*34790	30510
		*119667	*119667	*135628	*135628	*142418	*142418	*133402	128551	*107585	95041	*84768	72973	*76699	67263
-4.6 m	-15'	*62010	*62010	*62290	*62290	*64390	*64390	*51990	*51990	*41240	*41240			*34140	*34140
		*136708	*136708	*137326	*137326	*141955	*141955	*114618	*114618	*90919	*90919			*75266	75266
-6.1 m	-20'			*57850	*57850	*48220	*48220	*38240	*38240					*31290	*31290
				*127537	*127537	*106307	*106307	*84305	*84305					*68983	*68983

*Asterisk indicates load is limited by hydraulic capacity rather than tipping. Ratings are based on ISO standard No. 10567. Rated load capacity does not exceed 87% of hydraulic lift capacity or 75% of tipping load. Total weight of bucket and/or installed attachments must be deducted from the capacities shown above. Lift capacity chart is based on machine located on a solid, level and uniform surface. Load ratings are at the arm bucket pin location, use of any attachment point in a different location to handle objects could affect excavator lift performance.

PC2000-11

TRANSPORTATION GUIDE



MAJOR COMPONENT WEIGHTS

Backhoe: boom 28'7" 8700 mm arm 12'9" 3900 mm bucket 15.7 yd³ 12.0 m³ shoes 32" 810 mm double grouser

Work equipment assembly-backhoe

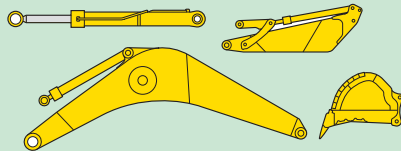

	Length		Width		Height		Weight	
Boom	30'0"	9170 mm	6'9"	2065 mm	10'6"	3195 mm	23.7 U.S. tons	21500 kg
Arm	18'0"	5495 mm	5'3"	1605 mm	6'9"	2055 mm	14.3 U.S. tons	13000 kg
Bucket	11'4"	3540 mm	9'2"	2790 mm	7'7"	2320 mm	10.7 U.S. tons	9700 kg

	Length		Weight		Quantity
Boom cylinder	14'0"	4270 mm	2.3 U.S. tons	2100 kg	2

Cab

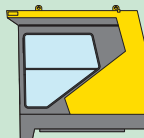

Cab base

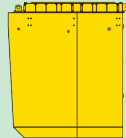

Revolving frame

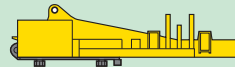

Power module

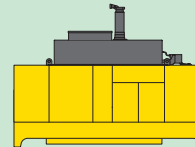

Fuel tank

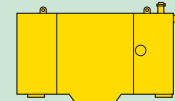

Length	9'6"	2885 mm	6'11"	2100 mm	24'10"	7575 mm	17'1"	5215 mm	10'2"	3100 mm
Width	6'2"	1880 mm	6'7"	2000 mm	10'5"	3180 mm	8'1"	2455 mm	2'10"	875 mm
Height	8'3"	2520 mm	8'10"	2700 mm	8'9"	2640 mm	10'11"	3320 mm	6'9"	2070 mm
Weight	4410 lb	2000 kg	5732 lb	2600 kg	5215 mm	26500 kg	37038 lb	16800 kg	4718 lb	2140 kg

Counter weight



Center frame

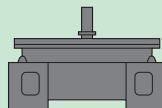

Undercarriage

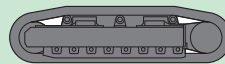

Hydraulic tank



Left floor



Length	20'6"	6240 mm	12'6"	3815 mm	24'5"	7435 mm	6'1"	1860 mm	8'3"	2510 mm
Width	3'8"	1115 mm	10'6"	3190 mm	5'8"	1720 mm	3'8"	1115 mm	10'9"	3280 mm
Height	4'11"	1505 mm	7'3"	2210 mm	6'4"	1920 mm	6'10"	2085 mm	10'4"	3150 mm
Weight	54675 lb	24800 kg	39904 lb	18100 kg	57321 lb x 2	26000 kg x 2	3858 lb	1750 kg	5071 lb	2300 kg

Others

Catwalk, step, handrail, small removed parts, etc.



STANDARD EQUIPMENT

ENGINE AND RELATED ITEMS:

- Air cleaner, double element dry
- Automatic engine warm-up system
- Electric priming pump for fuel
- Engine, Komatsu SAA12V140E-7 turbocharged, U.S. EPA Tier 4 Final certified.
- Fuel pre-filters with water separators
- Two cooling fans with fan guard (Hydraulic drive, for radiator and oil cooler), reversible

ELECTRICAL SYSTEM:

- Alternators, 24 V/2 x 90 A
- Auto decelerator and auto idling system
- Auto idle shutdown (adjustable)
- Batteries, 4 x 12 V/140 Ah
- Battery isolator and starting motor isolator
- Circuit breakers
- Electrical engine oil pan heater and coolant heater
- Horn interconnected with warning light
- Ladder operating alarm
- Lever lock auto-lock
- Lighting switches instrument panel
- Radio w/ auxiliary input (3.5 mm jack)
- Rear working light
- Secondary engine stop switch (ground access)
- Starting motors, 2 x 11 kW
- Working lights, 4 boom, 4 cab base, 3 fuel tank top front, 1 left front and 1 left under cab side catwalk, LED lamp system (2 lamps)

GUARDS AND COVERS:

- Dust resistant net for radiator and oil cooler
- Pump/engine room partition cover
- Power module under cover
- Travel motor guard

DRIVE SYSTEM:

- Planetary travel gear with axial piston motor
- Travel parking brake

HYDRAULIC SYSTEM:

- 4 variable displacement piston pumps (2 tandem pumps) for work equipment, travel and swing, 2 variable displacement piston pumps (1 tandem pump) for fan drive
- Control levers for work equipment and swing with PPC system
- Control levers and pedals for travel with PPC system
- Drain-filters for pumps & motors
- Electric open-center load sensing system
- Four control valves (two integrated valves) for work equipment, swing and travel
- Heavy lift mode
- High-pressure in-line oil filters
- Oil cooler
- One axial piston motor per track for travel with counterbalance valve
- Optimized electrical valve control for smooth and efficient compound movement
- Shockless boom control
- Two axial piston motors for swing with single stage relief valve
- Two-mode pressure setting for boom

OPERATOR'S CAB:

- Automatic air conditioners (Twin)
- Built-in top guard conforming to OPG level 2 (ISO10262)
- KomVision, all round monitoring system
- Large damper mounted and pressurized mining shovel cab with large windshield, lockable door, large twin wipers and washers, floor mats, cigarette lighter, ashtray, 12V power supply x 2, and cup holders
- Large high resolution LCD color monitor
- Lock lever
- Rearview monitoring system
- Seat belt indicator
- Seat belt, 78 mm 3"
- Seat, heated, high back, fully adjustable air suspension with retractable seat belt
- Sun shield
- Trainer's seat

OTHER:

- Automatic swing holding brake
- Beacon, 2 (Cab top, engine hood)
- Dual rearview mirrors
- Emergency engine stop switch and fuel cut-off lever
- Fuel tank, 3400 L **898.2 U.S. Gal**
- Fully-automatic greasing system with 200 L **52.8 U.S. Gal**
- Fully hydraulic operated stairway and full 45° access to cab
- General tool kit
- Jump start receptacle
- KOMTRAX Plus® (vehicle health monitoring system)
- Light in machine cab
- Maintenance light
- Manual grease gun for track adjuster
- PM tune-up service connection
- Rear reflectors
- Satellite communication system for KOMTRAX Plus® (Iridium)
- Service center system, full quick charge system (grease, oils, fuel, coolant)
- Slip-resistant plates
- Step light with timer
- Travel alarm
- Wide catwalk and large handrail

UNDERCARRIAGE:

- 810 mm **32"** double grouser shoes
- 8 track rollers/3 carrier rollers (Each side)
- Hydraulic Idler Cushion (HIC) with shock absorbing accumulator
- Track guiding guard (Separate type)



OPTIONAL EQUIPMENT

- 1010 mm **40"** triple grouser shoes
- 3900 mm **12'10"** backhoe arm assembly
- 8700 mm **28'7"** backhoe boom assembly
- Coolant heater, fuel combustion type
- Full length track guiding guards
- Heavy-duty rock bucket

AESS933-01

©2019 Komatsu America Corp.

Printed in USA

AD10(POD)OTP

10/19 (EV-1)

KOMATSU®

Note: All comparisons and claims of improved performance made herein are made with respect to the prior Komatsu model unless otherwise specifically stated.

www.komatsuamerica.com

Komatsu America Corp. is an authorized licensee of Komatsu Ltd. Materials and specifications are subject to change without notice

KOMATSU®, Komatsu Care®, KOMTRAX® and KOMTRAX Plus® are registered trademarks of Komatsu Ltd. All other trademarks and service marks used herein are the property of Komatsu Ltd., Komatsu America Corp. or their respective owners or licensees.