

SCRAP HANDLING

LET'S HANDLE IT!



FUCHS[®]

A TEREX BRAND

MHL331 & 335 F - MORE POWER AND REACH WHILE MAINTAINING COMPACT DIMENSIONS

With its substantial reach of 12 m and high load capacity, the MHL331 is one of the most popular material handlers for waste and scrap recycling. The MHL335 combines all the advantages of its little sister MHL331 and supplements it with an enlarged undercarriage. The support base of 5.1 x 4.3 metres provides extra stability when maximum loads are frequently moved at the maximum reach.

Fuchs MHL331-335 F

Engine Power: 115 kW
Operating Weight w/o Attachments MHL331: 22.8–24.2 t
Operating Weight w/o Attachments MHL335: 23.9–25.5 t
Reach: max. 12 m





MHL340 F - THE ALL-ROUNDER

With an impressive maximum reach of 13.7 m and high load capacity, the Fuchs MHL340 is one of the most versatile models in scrap and waste handling. Whether you are dealing with mixed scrap, household waste, construction waste, or biomass: our MHL340 F is the optimal machine for your needs. Our finely tuned 2-circuit hydraulics ensure fast, precise, and powerful work cycles with maximum, functional performance.

Fuchs MHL340 F

Engine Power: 129 kW
Operating Weight w/o Attachments: 28.4–30.6 t
Reach: max. 13.7 m

MHL350 F - THE BENCHMARK

State-of-the-art engine technology paired with pioneering hydraulics make the MHL350 one of the quickest and most sensitive loading machines in its class. Operating weight of up to 35.5 tonnes, maximum 16-metres reach and a 3-metres undercarriage width for a particularly secure stand: this data impressively demonstrates just what the MHL350 can do.

Fuchs MHL350 F

Engine Power: 160 kW

Operating Weight w/o Attachments: 33.0–35.5 t

Reach: max. 16 m





MHL360 - THE HIGH PERFORMANCE CLASS

➤ With state-of-the-art hydraulics, efficiency-increasing recuperation and an extremely comfortable cab, the MHL360 sets standards in modern material handling. With the combination of power and low emissions, as well as the equally high-torque and sensitive hydraulics, even the most demanding of loading tasks can be carried out efficiently.

Fuchs MHL360 F

Engine Power: 190 kW
Operating Weight w/o Attachments: 43.5–48.8 t
Reach: max. 18 m

MHL370 F - XL SINGLE SOLID RUBBER TYRES AS STANDARD

➤ MHL370 impresses with its massive undercarriage, which creates enough space for the 59" SETCO single solid rubber tyres. Counterweight, lifting cylinder, and motor power have been significantly increased. This serves a single purpose: maximum performance even in the most difficult applications. The MHL370 not only cuts a good figure on uneven terrain - the impressive load capacity and excellent stability make the 370 the first choice for large, unpaved scrapyards or steelmills.

Fuchs MHL370 F

Engine Power: 230 kW
Operating Weight w/o Attachments: 49.8–52.0t
Reach: max. 18 m



MHL375 F - THE SPECIALIST FOR DEMANDING, INDUSTRIAL MATERIAL HANDLING

Designed from the ground up to cater for the high demands of scrap and bulk goods handling, our MHL375 F is fine-tuned for maximum efficiency with great handling performance. Steelmills and inland ports in particular appreciate the solid Fuchs construction along with the efficient performance that Fuchs is renowned for.

Fuchs MHL375 F

Engine Power: 245 kW
Operating Weight w/o Attachments: 64.3–66.5 t
Reach: max. 20 m



MHL380 F - WELL-EQUIPPED FOR PORT AND SCRAP-HANDLING

➤ Regardless of whether it is multi-shift operation in steelmills or work in a harsh coastal climate, the MHL380 is the perfect and reliable tool. Thanks to our modular design principle, the MHL380 can also be individually adapted to your needs. Banana booms for unloading ships, wide crawler undercarriages for minimal ground pressure or pylons for a maximum overview – all this and much more is available for your MHL380 F.

Fuchs MHL380 F

Engine Power: 245 kW
Operating Weight w/o Attachments: 68.0–71.8 t
Reach: max. 22 m

MHL390 F - THE POWER PACK FOR THE TOUGHEST JOBS

Whether it is a diesel or electric motor, mobile, gantry or crawler undercarriage, with or without pylon – the MHL390 F can be flexibly adapted to your specific requirements. Even in the standard version, our MHL390 offers a comprehensive package of features for industrial material handling. With the powerful and fuel-efficient 300 kW diesel engine (Stage V), a maximum reach of 24.5 m, two swivel drives and the unique Fuchs service platform, the MHL390 is the perfect machine for the most demanding applications.

Fuchs MHL390 F

Engine Power: 300 kW
Operating Weight w/o Attachments: 76.2–87 t
Reach: max. 24.5 m



ATTACHMENTS AND LOADING EQUIPMENT

- Dipperstick for cactus or clamshell grab
- Banana boom for better reach into cargo holds
- Pipe rupture valves with regeneration function as standard for all MHL360 and bigger models
- Grab rotation speed and pressure regulation
- Optimally arranged hydraulic pipes and hoses

CABIN

- Hydraulically adjustable cab
- Large skylight
- Sliding window in cab door
- Safety glass
- Automatic air conditioning system

SERVICE PLATFORM

- Comfortable access to engine, main hydraulic valve block, diesel & DEF tank etc.
- Service and maintenance tasks can be performed safely and conveniently
- Unique in the market

ENGINE

Diesel engine

- Best-in-class for fuel economy in its power segment
- Latest EU-Stage V emission technology
- ROW solutions
- Covered and protected EAT system

Electric motor

- Low maintenance and operating costs
- Low noise
- Zero local emissions

UPPERCARRIAGE

- Separated cooling system for engine, hydraulic oil cooler and AC condenser
- Rear and side view camera
- Temperature-controlled fan drives
- Highly energy-efficient hydraulics

UNDERCARRIAGE

- Mobile
- Crawler
- Stationary



GREAT FEATURES COME STANDARD WITH YOUR FUCHS



FUCHS SERVICE PLATFORM

Safe place for daily checks and maintenance

HYDRAULIC PIPES

Metal pipes, great longevity



SEPARATED COOLING SYSTEM

For engine and hydraulic oil cooler



DUAL-EAR PIN CONNECTION

Optimal distribution of force, high longevity, less wear and tear



QUICK FUSE CHECK BUTTON

Fuses can be checked quickly and easily

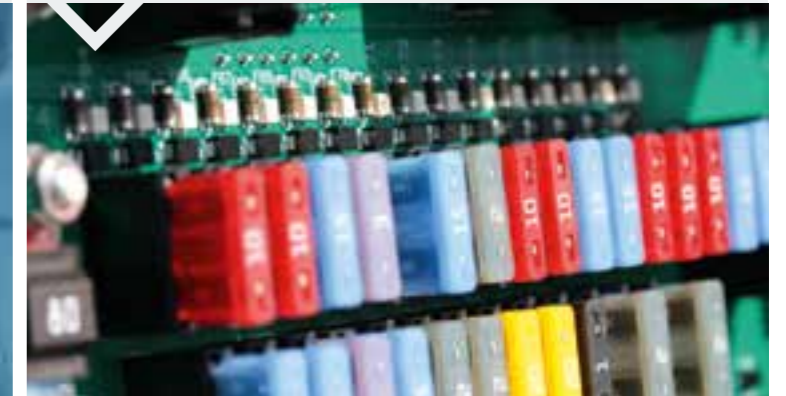

STORAGE SPACE

Air conditioned storage and cup holder



CONTROL DISPLAY

Touchscreen LCD display: the dashboard provides all important information at a glance



OIL PRESSURE AND FLOW ADJUSTMENT

Parameters can be easily fine-tuned to your personal preference



SLEWING RING

Internally geared double row slewing ring bearing, greasing via automatic lubrication system



SPECIAL OPTIONS FOR SCRAP APPLICATIONS

BOOM CYLINDER DAMPING SYSTEM

For smooth operation



CAB GUARD (FRONT & TOP)

Exceptional safety for operator



FUCHS QUICKCONNECT & CABIN WITH BULLET-PROOF GLASS

FUCHS ORANGE PEEL GRAPPLE

Specially designed for scrap handling application



MAGNET SOCKET PROTECTION

Well protected against impact



CRAWLER UNDERCARRIAGE

Minimum amount of ground pressure, suitable for challenging ground conditions



HIGH PRESSURE FILTRATION SYSTEM FOR ATTACHMENTS

Effective protection against contamination of hydraulic oil caused by damaged or leaking attachments



ELECTRIC DRIVEN MATERIAL HANDLER

Electric drives are today's forward-looking trend. This is especially the case with indoor applications, stationary machines, and machines with rail undercarriage, in which powerful zero-emission electric drives that are extremely easy to maintain have very tangible advantages. They include low operating and servicing costs, low noise emissions and heat build-up, and the extensive use of standard components from our range of diesel driven models, which ensures that spare parts are widely available.

The right connection, every single time: the cable lengths and cable reel designs of Fuchs electric machines are adapted to each customer's specific needs in line with the required reach and the available connection options on site.

Thanks to the Power Pack, users of electric driven material handlers can enjoy even greater flexibility. The Power Pack allows electric driven material handlers to be driven from one power socket to the other independently of any external electricity supply. This is made possible by an integrated diesel-powered hydraulic unit.



ZERO EMISSION

No exhaust gases, little noise and very little heat output: ideal features when operating indoors or close to residential areas.



MHL331/335

 115 kW |
  115 kW |
  90 kW |
  25.5 t |
  5.3 m

Loading equipment

- with dipperstick 11 m / 12 m
- with universal stick 10.7 m

Engine

- EU Stage V/ U.S. Tier 4
- EU Stage IIIA/ U.S. Tier 3 *)
- Deutz TCD 4.1 L4
- 4-cylinder in-line engine

Cab systems

- vertically adjustable





*) for low-regulated markets



MHL331 F MHL331 F (Pylon) RHL331 F RHL331 F (Pylon) AHL331 F AHL331 F (Pylon)



MHL335 F MHL335 F (Pylon) RHL335 F AHL335 F

 EU Stage V/ U.S. Tier 4 E |
  EU Stage IIIA/ U.S. Tier 3 |
  Electric motor |
  Max. service weight without attachments |
  Max. viewing height





MHL340

 129 kW
  128 kW
  110 kW
  30.6 t
  5.6 m

Loading equipment

- with dipperstick 12.6 m / 13.7 m
- with universal stick 12.2 m
- FQC 11.0 m

Engine

- EU Stage V/ U.S. Tier 4
- EU Stage IIIA/ U.S. Tier 3 *)
- Deutz 6.1 L6 / TCD2012 L06 2V
- 6-cylinder inline

Cab systems

- vertically adjustable

*) for low-regulated markets



MHL340 F



RHL340 F



AHL340 F







MHL340 F (Pylon)



RHL340 F (Pylon)



AHL340 F (Pylon)

 EU Stage V/ U.S. Tier 4 E
  EU Stage IIIA/ U.S. Tier 3
  Electric motor
  Max. service weight without attachments
  Max. viewing height





MHL350

 160 kW |
  148 kW |
  132 kW |
  35.5 t |
  5.6 m

Loading equipment

- with dipperstick 15 m / 16 m
- with universal stick 14.7 m
- FQC 11.0 m

Engine

- EU Stage V/ U.S. Tier 4
- EU Stage IIIA/ U.S. Tier 3 *)
- Deutz 6.1 L6 / TCD2013 L6
- 6-cylinder inline

Cab systems

- vertically adjustable

*) for low-regulated markets



MHL350 F



RHL350 F



AHL350 F



MHL350 F (Pylon)



RHL350 F (Pylon)



AHL350 F (Pylon)



EU Stage V/ U.S. Tier 4 E



EU Stage IIIA/ U.S. Tier 3



Electric motor



Max. service weight without attachments



Max. viewing height





MHL360

 190 kW
  186 kW
  160 kW
  48.8 t
  6.1 m

Loading equipment

- with dipperstick 16.5 m / 18 m
- with banana boom 18 m

Engine

- EU Stage V/ U.S. Tier 4
- EU Stage IIIA/ U.S. Tier 3 *)
- Deutz TCD 7.8 L6 4V / TCD2013 L06 2V
- 6-cylinder inline

Cab systems

- vertically adjustable
- vertically and horizontally adjustable

*) for low-regulated markets



MHL360 F



RHL360 F



AHL360 F







MHL360 F (Pylon)



RHL360 F (Pylon)



AHL360 F (Pylon)

 EU Stage V/ U.S. Tier 4 E
  EU Stage IIIA/ U.S. Tier 3
  Electric motor
  Max. service weight without attachments
  Max. viewing height





MHL370

230 kW |
 230 kW |
 200 kW |
 52.0 t |
 6.1 m

Loading equipment

- with dipperstick 16.5 m / 18 m
- with banana boom 18 m

Engine

- EU Stage V/ U.S. Tier 4
- EU Stage IIIA/ U.S. Tier 3 ^{*)}
- Deutz TCD 7.8 L6
- 6-cylinder inline

Cab systems

- vertically adjustable
- vertically and horizontally adjustable

^{*)} for low-regulated markets



MHL370 F



RHL370 F



AHL370 F



MHL370 F (Pylon)



RHL370 F (Pylon)



AHL370 F (Pylon)

EU Stage V/ U.S. Tier 4 E |
 EU Stage IIIA/ U.S. Tier 3 |
 Electric motor |
 Max. service weight without attachments |
 Max. viewing height

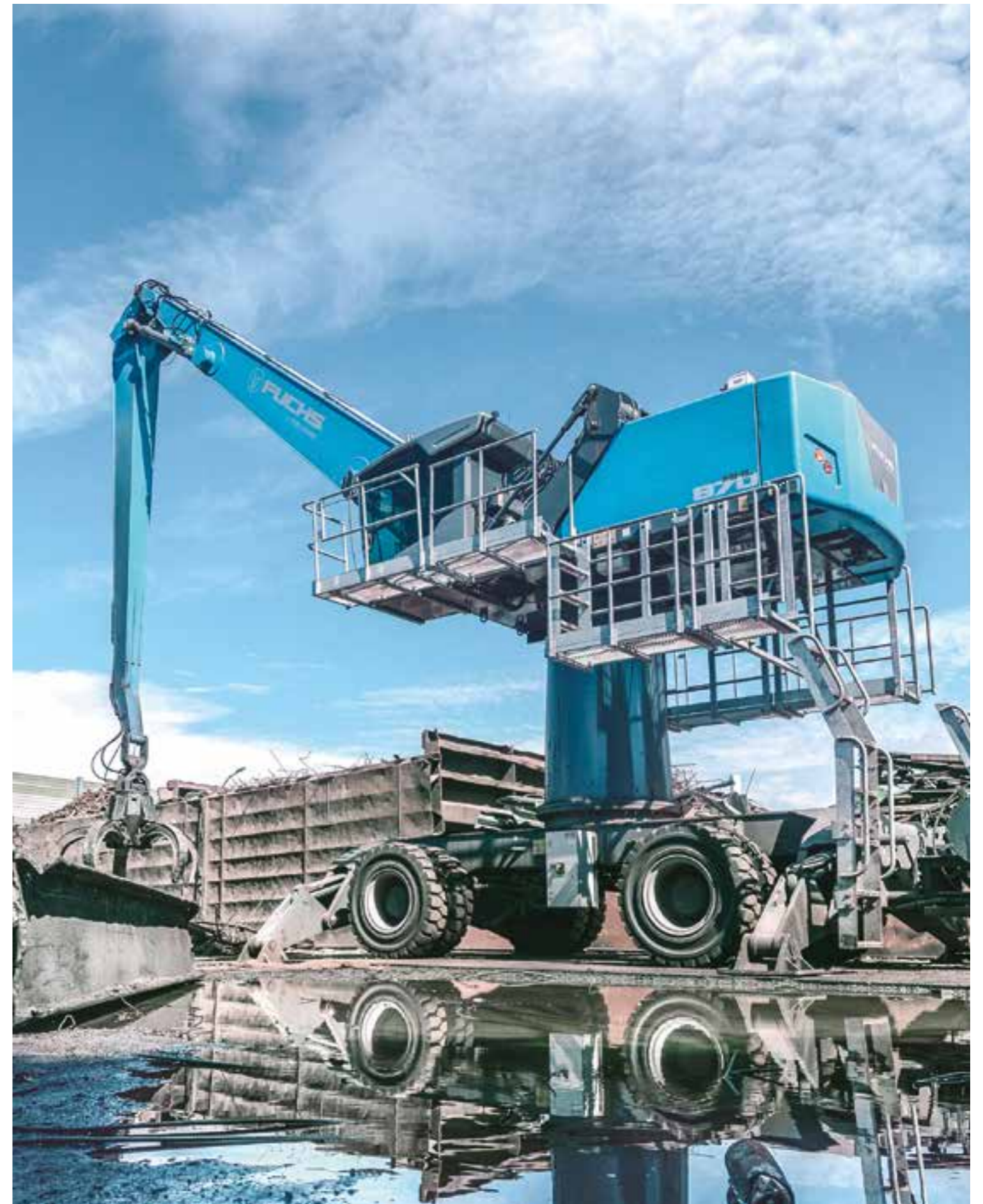



MHL375

 245 kW
  245 kW
  220 kW
  66.5 t
  6.0 m

Loading equipment

- with dipperstick 18 m / 20 m

Engine

- EU Stage V/ U.S. Tier 4
- EU Stage IIIA/ U.S. Tier 3 ^{*)}
- Deutz TCD 7.8 L6
- 6-cylinder inline

Cab systems

- vertically adjustable
- vertically and horizontally adjustable

^{*)} for low-regulated markets



MHL375 F







AHL375 F



MHL375 F (Pylon)



AHL375 F (Pylon)

 EU Stage V/ U.S. Tier 4 E
  EU Stage IIIA/ U.S. Tier 3
  Electric motor
  Max. service weight without attachments
  Max. viewing height

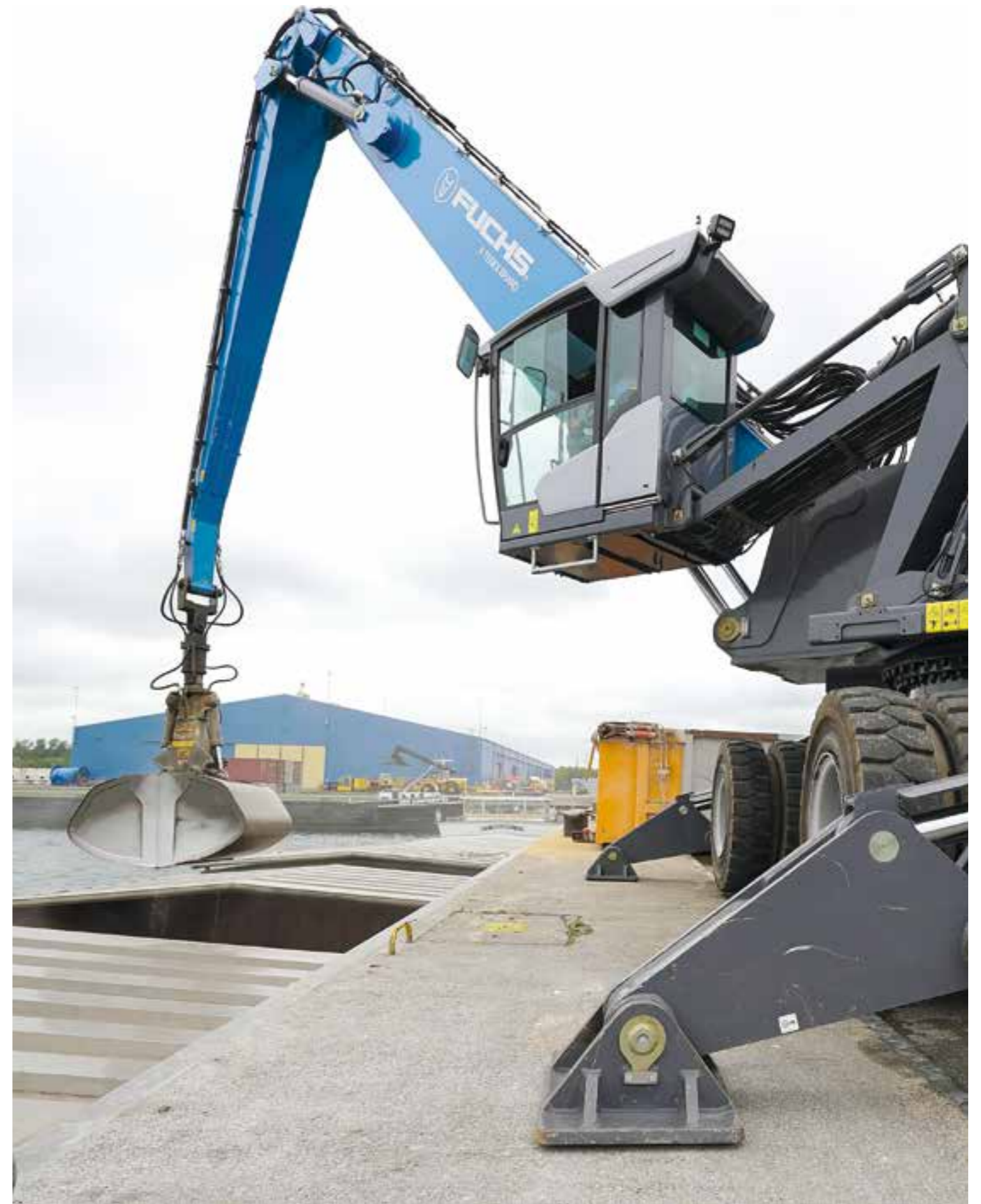



MHL380



Loading equipment

- with dipperstick 18 m / 20 m / 22 m
- with banana boom 20 m / 22 m

Engine

- EU Stage V/ U.S. Tier 4
- EU Stage IIIA/ U.S. Tier 3 *)
- Deutz TCD 7.8 L6
- 6-cylinder inline

Cab systems

- vertically adjustable
- vertically and horizontally adjustable

*) for low-regulated markets



MHL380 F



RHL380 F



AHL380 F



MHL380 F (Pylon)



RHL380 F (Pylon)



AHL380 F (Pylon)

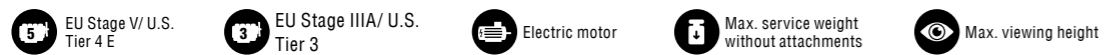



MHL390

300 kW |
 273 kW |
 250 kW |
 87 t |
 6.1 m

Loading equipment

- with dipperstick 22 m / 24 m
- with banana boom 24.5 m

Engine

- EU Stage V/ U.S. Tier 4
- EU Stage IIIA/ U.S. Tier 3 *)
- Deutz TCD 12.0 V6 / TCD2015 V06
- 6-cylinder inline

Cab systems

- vertically adjustable
- vertically and horizontally adjustable
- Cabin system „Port“

*) for low-regulated markets

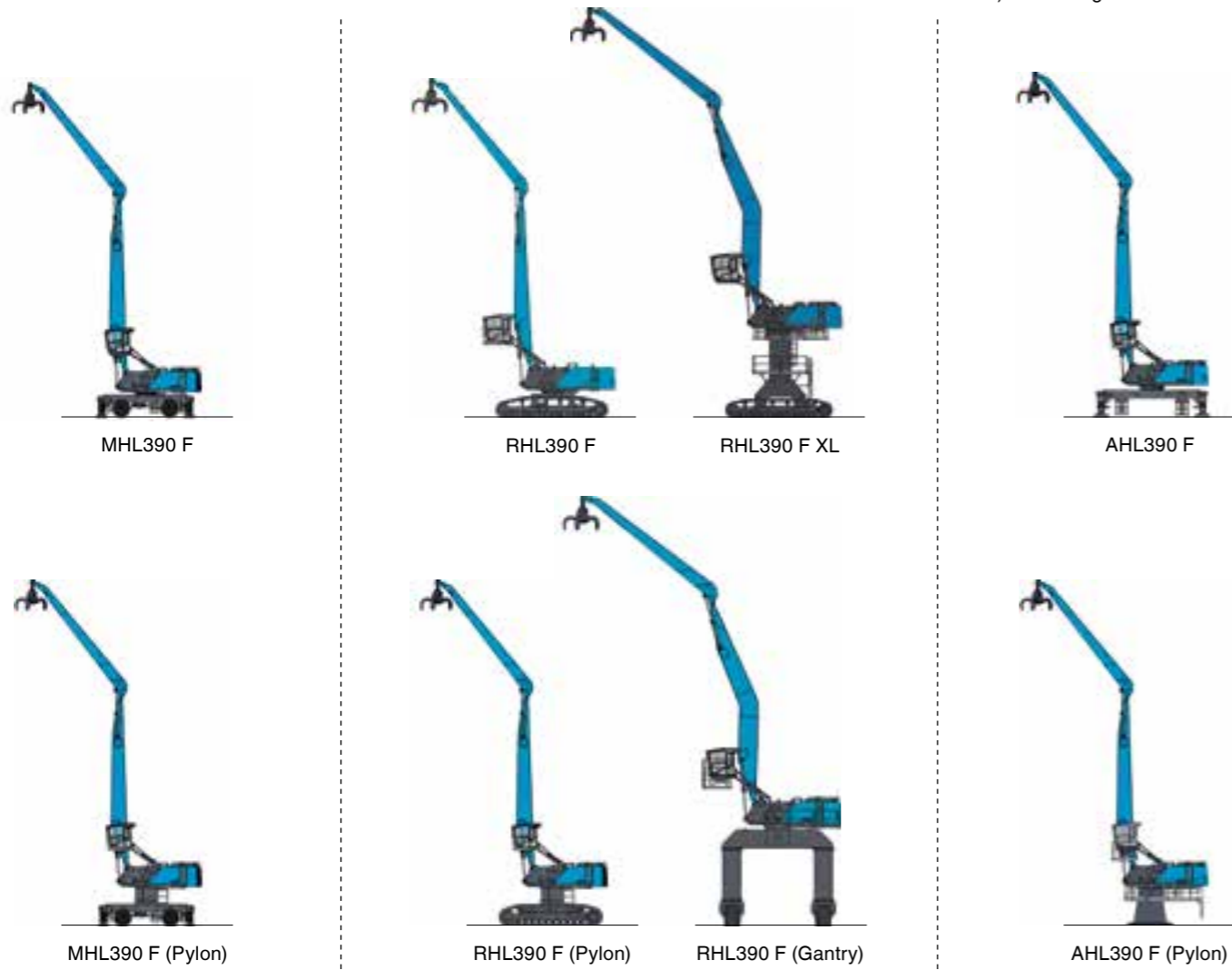

EU Stage V/ U.S. Tier 4 E |
 EU Stage IIIA/ U.S. Tier 3 |
 Electric motor |
 Max. service weight without attachments |
 Max. viewing height

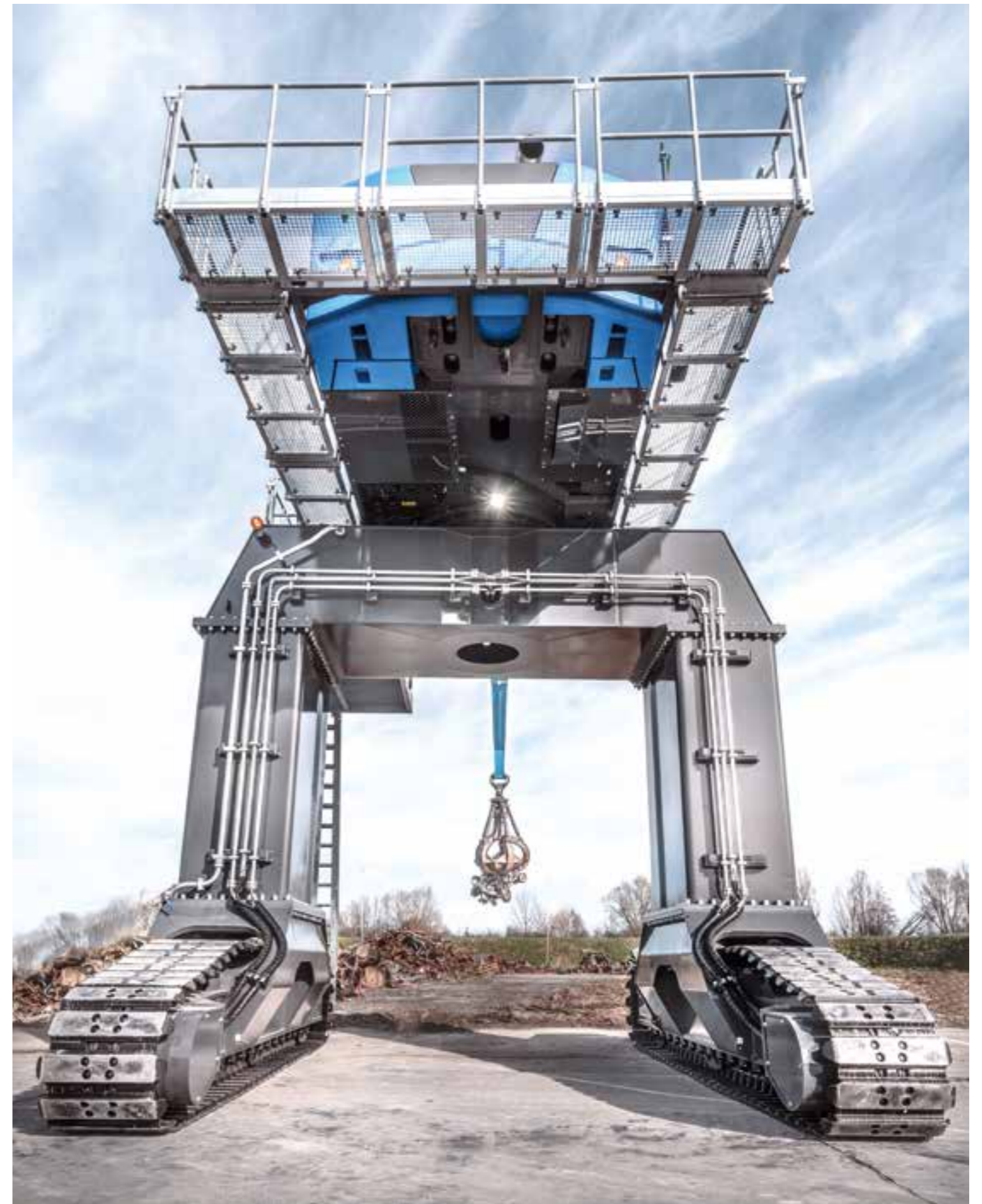



SAFETY FEATURES

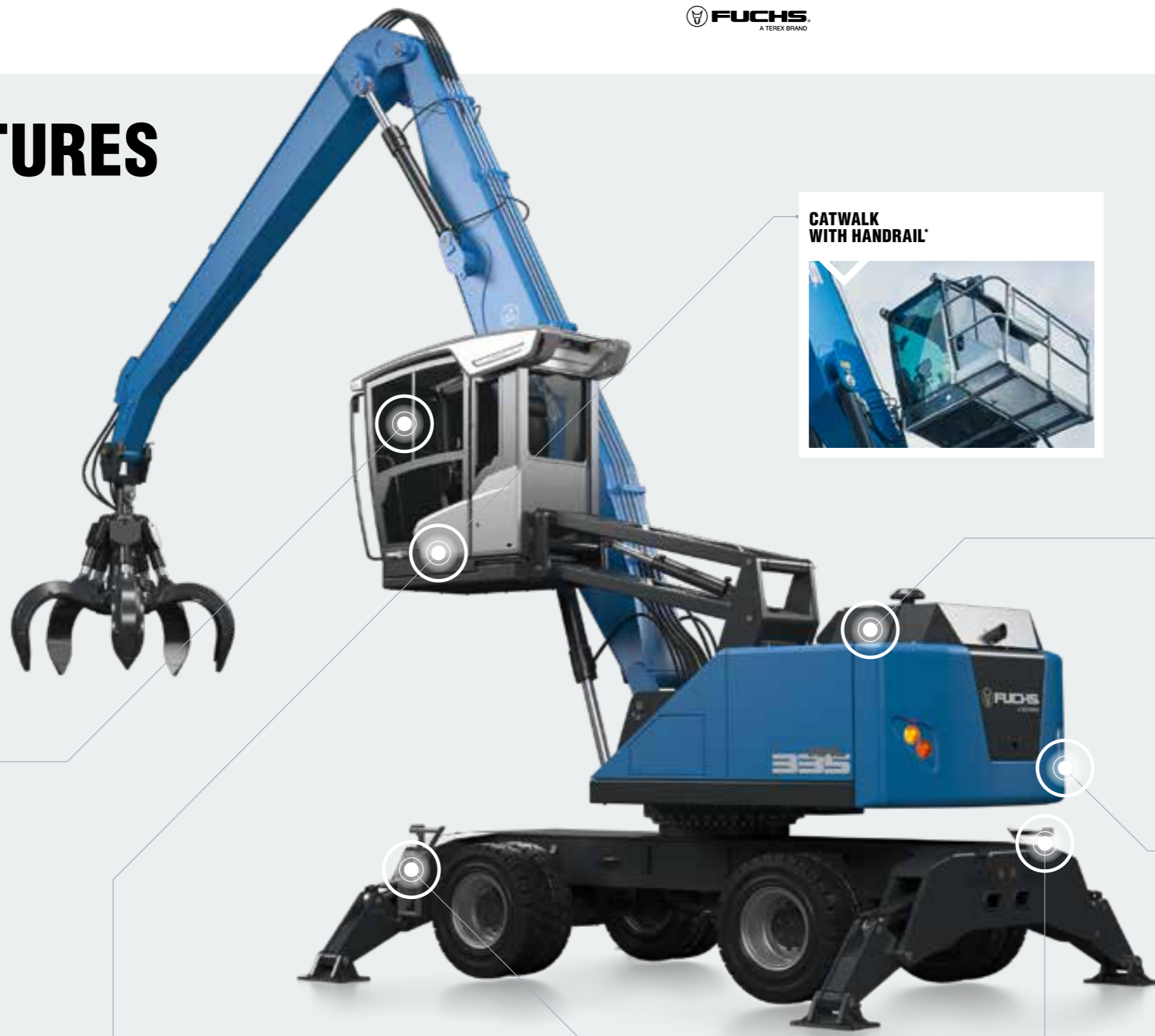

PROXIMITY SWITCH FOR DIPPERSTICK



PILOT PRESSURE CONTROL



OVERLOAD WARNING DEVICE*



OVERLOAD AND WORK AREA CONTROL*



CATWALK WITH HANDRAIL*



SERVICE PLATFORM



LOG- OUT TAG- OUT BATTERY MASTER SWITCH



COMFORT ACCESS*



ADDITIONAL STEPS AT THE FRONT AND REAR OF UNDERCARRIAGE*



* Option

MODULAR SYSTEM

ATTACHMENTS



WORK EQUIPMENT

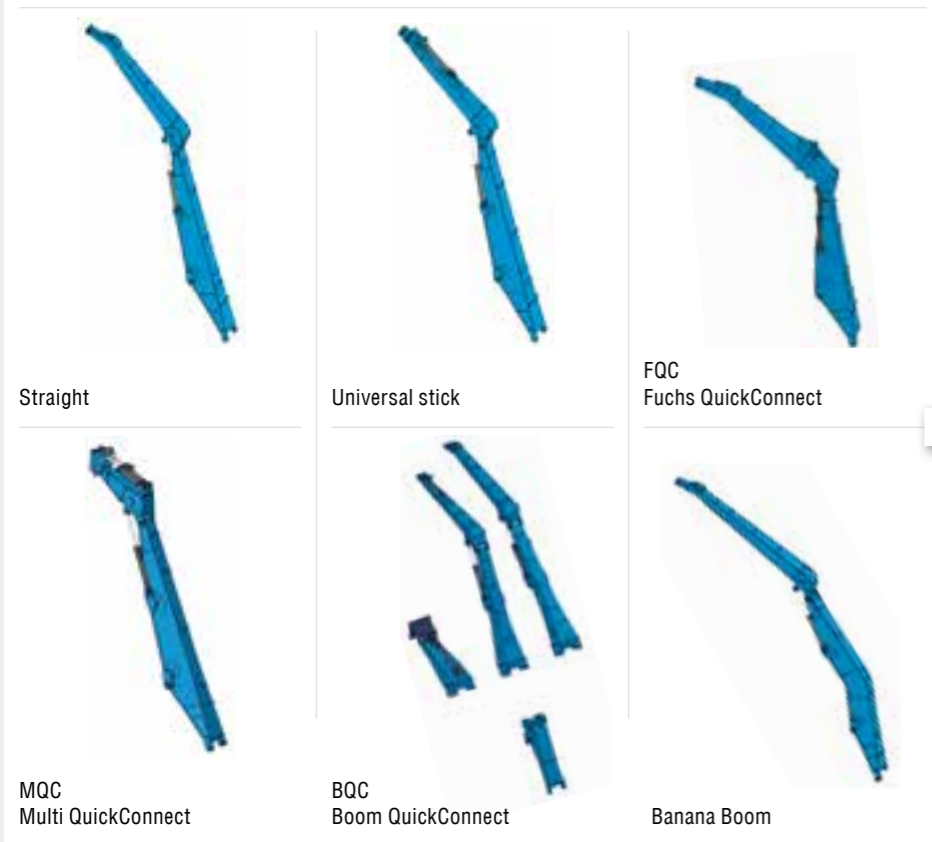

CAB SYSTEMS

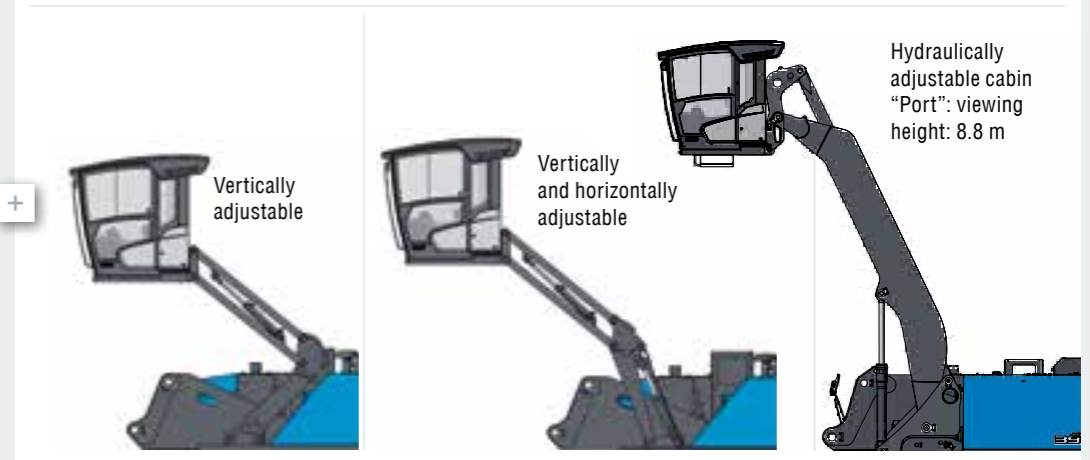

ENGINES

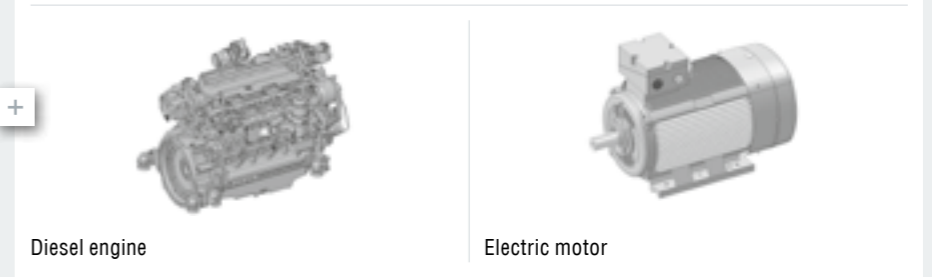

OPTIONS

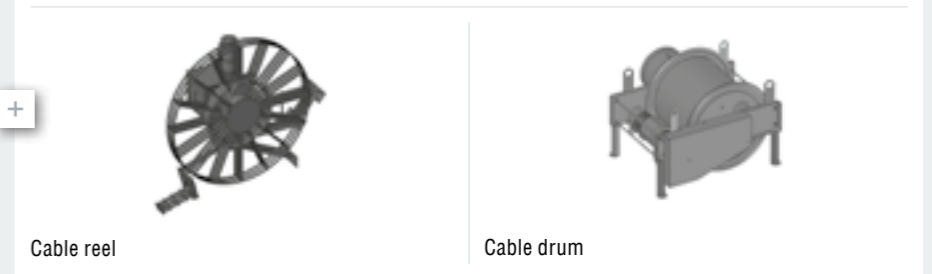

UNDERCARRIAGES





FUCHS[®]

A TEREX BRAND

WORKS FOR YOU.[™]

www.terex-fuchs.com

February 2021. Product specifications and prices are subject to change without notice or obligation. The photographs and/or drawings in this document are for illustrative purposes only. Refer to the appropriate Operator's Manual for instructions on the proper use of this equipment. Failure to follow the appropriate Operator's Manual when using our equipment or to otherwise act irresponsibly may result in serious injury or death. The only warranty applicable to our equipment is the standard written warranty applicable to the particular product and sale and Terex makes no other warranty, express or implied. © Terex Corporation 2021 - Terex, the Terex Crown design, Fuchs and Works For You are trademarks of Terex Corporation or its subsidiaries.

Terex[®] Deutschland GmbH | Industriestraße 3 | 76669 Bad Schönborn | Germany | Fon: +49 (0) 7253 84-0 | Fax: +49 (0) 7253 84-102 | info@terex-fuchs.com

