

MOTOR		
Marca/modelo	Cummins QSB6.7	
Tipo	Motor diésel turboalimentado de 4 ciclos con refrigeración de aire de carga	
Potencia del volante del motor	SAE J1995 (bruta)	242 HP (180 kW) a 1950 rpm
	SAE J1349 (neta)	230 HP (171 kW) a 1950 rpm
	DIN 6271/1 (bruta)	245 PS (180 kW) a 1950 rpm
	DIN 6271/1 (neta)	233 PS (171 kW) a 1950 rpm
Par máximo	100,9 kgf-m (729,8 lbf-pie) a 1500 rpm	
Diámetro x carrera	107 x 124 mm (4.21" x 4.88")	
Desplazamiento del pistón	6700 cc (409 pulg.3)	
Baterías	2 x 12 V x 160 Ah	
Motor de arranque	Denso 24 V - 4,8 kW	
Alternador	Denso 24 V - 95 A	

SISTEMA HIDRÁULICO	
BOMBA PRINCIPAL	
Tipo	Bombas de pistones axiales de caudal variable
Flujo máximo	2 x 273 l/min (72.1 gpm USA / 60.1 gpm británico)
Bomba secundaria para el circuito piloto	Bomba de engranajes

Sistema de bombeo con ahorro de combustible y detección transversal

MOTORES HIDRÁULICOS	
Traslación	Motor de pistón axial de desplazamiento variable
Giro	Motor de pistón axial

AJUSTE DE LA VÁLVULA DE DESCARGA	
Circuitos de implementación	350 kgf/cm ² (4980 psi)
Traslación	350 kgf/cm ² (4980 psi)
Multiplicador de potencia (pluma, balancín y cuchara)	380 kgf/cm ² (5400 psi)
Circuito de giro	300 kgf/cm ² (4270 psi)
Circuito piloto	40 kgf/cm ² (570 psi)
Válvula de servicio	Instalada

CILINDROS HIDRÁULICOS	
Número de cilindros (diámetro x carrera)	Pluma: Ø 140 x 1465 mm
	Balancín: Ø 150 x 1765 mm
	Cuchara: Ø 135 x 1185 mm

ACCIONAMIENTO Y FRENOS	
Método de accionamiento	Completamente hidrostático
Motor de accionamiento	Motor de pistón axial, diseño de zapata
Sistema de reducción	Engranaje de reducción planetario
Tracción máx. de la barra de arrastre	27.300 kgf (60,200 lbf)
Velocidad de desplazamiento máx. (alta/baja)	5,8 km/h (3,6 mph) / 3,2 km/h (2,0 mph)
Pendiente máxima superable	35° (70%)
Freno de estacionamiento	Multidisco húmedo

CONTROL	
Pedales y palancas de mando accionados por presión piloto con palanca desmontable para su uso casi sin esfuerzo ni fatiga.	
Control piloto	Dos palancas de mando con una palanca de seguridad (IZQ): Giro y balancín (DCH): Pluma y cuchara (ISO)

CONTROL	
Desplazamiento y dirección	Dos palancas con pedales
Aceleración del motor	Eléctrica, tipo dial

SISTEMA DE GIRO	
Motor de giro	Motor de pistón axial de desplazamiento fijo
Reducción de giro	Reducción de engranaje planetario
Lubricación del cojinete de giro	Bañado en grasa
Freno de giro	Multidisco húmedo
Velocidad de giro	10,2 rpm

CAPACIDADES DE LLENADO DE SERVICIO			
	litro	gal EE. UU.	gal RU
Nuevo llenado			
Depósito de combustible	500	132.1	110.0
Refrigerante del motor	40	10.6	8.8
Aceite del motor	23,1	6.1	5.1
Dispositivo de giro	11	2.9	2.4
Accionamiento final (cada uno)	7,8	2.06	1.72
Sistema hidráulico (depósito incluido)	330	87.2	72.6
Depósito hidráulico	190	50.2	41.8
DEF/AdBlue®	42,5	11.2	9.3

TREN DE RODAJE	
El bastidor central de tipo de soporte en X está soldado íntegramente con los bastidores de la oruga de la sección de caja reforzada. El tren de rodaje incluye rodillos lubricados, ruedas guía, ajustadores de oruga con piñones y muelles amortiguadores, y una cadena de oruga con zapatas de doble o triple garra.	
Bastidor central	Tipo de soporte en X
Bastidor de la oruga	Tipo de caja pentagonal
Número de zapatas en cada lado	48 EA
Número de rodillos transportadores en cada lado	2 EA
Número de rodillos de oruga en cada lado	9 EA
Número de barandillas protectoras en cada lado	2 EA

PESO OPERATIVO (APROXIMADO)	
Peso operativo, incluidos la pluma de 6250 mm (20' 6"); el balancín de 3050 mm (10' 0"); la cuchara colmada SAE de 1,27 m ³ (1.66 yd ³); el lubricante, el depósito de combustible total, el depósito hidráulico total y todos los equipos estándar.	

PESO OPERATIVO				
Zapatas	Ancho mm (pulg.)	Peso operativo		Presión de tierra kgf/cm ² (psi)
		kg (lb)		
Arista triple	600 (24")	HX300 L	30200 (66,580)	0,58 (8,25)
		HX300 NL	30000 (66,140)	0,58 (8,25)
		HX300 HW	33040 (72,840)	0,64 (9,10)
	700 (28")	HX300 L	30770 (67,840)	0,51 (7,25)
		HX300 HW	33610 (74,100)	0,56 (7,95)
		HX300 L	31150 (68,670)	0,45 (6,40)
800 (32")	HX300 HW	33990 (74,940)	0,49 (6,97)	
	900 (36")	HX300 L	31530 (69,510)	0,41 (5,83)
Arista doble	710 (28")	HX300 L	31680 (69,840)	0,52 (7,39)
		HX300 HW	34520 (76,100)	0,56 (7,96)

GUÍA DE SELECCIÓN DE CUCHARA Y FUERZA DE EXCAVACIÓN

HX300 L

CUCHARAS

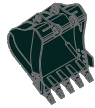

1,27 (1.66)
1,50 (1.96)

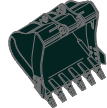

1,73 (2.26)
1,85 (2.42)

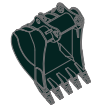

◆ 1,27 (1.66)
◆ 1,46 (1.91)

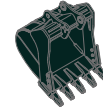

◆ 1,33 (1.74)
◆ 1,50 (1.96)



★ 0,52 (0.68)

Norma SAE
m³ (yd³)

Capacidad m ³ (yd ³)		Ancho mm (pulg.)		Peso kg (lb)	Recomendación en mm (pies-pulg.)				
Norma SAE	Norma CECE	Sin cuchillas laterales	Con cuchillas laterales		6250 (20' 6") Pluma				10200 (33' 6") Pluma
					2100 (6' 11") Balancín	2500 (8' 2") Balancín	3050 (10' 0") Balancín	3750 (12' 4") Balancín	7850 (25' 9") Balancín
1,27 (1.66)	1,11 (1.45)	1325 (52.2)	1410 (55.5)	1100 (2,430)	●	●	●	⊙	-
1,50 (1.96)	1,30 (1.70)	1515 (59.6)	1600 (63.0)	1180 (2,600)	●	●	⊙	○	-
1,73 (2.26)	1,51 (1.98)	1605 (63.2)	1690 (66.5)	1280 (2,820)	⊙	⊙	○	○	-
1,85 (2.42)	1,61 (2.11)	1700 (66.9)	1780 (70.1)	1330 (2,930)	⊙	○	○	○	-
◆ 1,27 (1.66)	1,11 (1.45)	1380 (54.3)	-	1290 (2,840)	●	●	⊙	⊙	-
◆ 1,46 (1.91)	1,28 (1.67)	1535 (60.4)	-	1380 (3,040)	⊙	⊙	⊙	○	-
◆ 1,33 (1.74)	1,16 (1.52)	1420 (55.9)	-	1470 (3,240)	⊙	⊙	⊙	○	-
◆ 1,50 (1.96)	1,30 (1.70)	1550 (61.0)	-	1550 (3,420)	⊙	⊙	●	○	-
★ 0,52 (0.68)	0,45 (0.59)	945 (37.2)	1020 (40.2)	460 (1,010)	-	-	-	-	⊙

- ◆ Cuchara para trabajo pesado
- ◆ Cuchara para rocas pesadas
- ★ Cuchara de largo alcance

- : Se aplica a materiales con una densidad de 2000 kg/m³ (3,370 lb/yd³) o inferior
- ⊙ : Se aplica a materiales con una densidad de 1600 kg/m³ (2,700 lb/yd³) o inferior
- : Se aplica a materiales con una densidad de 1100 kg/m³ (1,850 lb/yd³) o inferior

ACCESORIO

Las plumas y los balancines se sueldan con un diseño de sección de caja completa de baja tensión.
Plumas de 6,25 m (20' 6") y 10,2 m (33' 6") y balancines de 2,1 m (6' 11"); 2,5 m (8' 2"); 3,05 m (10' 0"); 3,75 m (12' 4") y 7,85 m (25' 9") disponibles.

FUERZA DE EXCAVACIÓN

Pluma	Longitud	mm (ft.in)	6250 (20' 6")				10200 (33' 6")	Observaciones:
	Peso	kg (lb)	2670 (5,900)				3420 (7,540)	
Balancín	Longitud	mm (ft.in)	2100 (6' 11")	2500 (8' 2")	3050 (10' 0")	3750 (12' 4")	7850 (25' 9")	[]: Multiplicador de potencia
	Peso	kg (lb)	1480 (3,260)	1460 (3,220)	1570 (3,460)	1710 (3,770)	1690 (3,730)	
Fuerza de excavación de la cuchara	SAE	kN	168,7 [183,1]	168,7 [183,1]	168,7 [183,1]	168,7 [183,1]	70	
		kgf	17200 [18670]	17200 [18670]	17200 [18670]	17200 [18670]	7100	
		lbf	37920 [41170]	37920 [41170]	37920 [41170]	37920 [41170]	15650	
	ISO	kN	192,2 [208,7]	192,2 [208,7]	192,2 [208,7]	192,2 [208,7]	80	
		kgf	19600 [21280]	19600 [21280]	19600 [21280]	19600 [21280]	8200	
		lbf	43210 [46910]	43210 [46910]	43210 [46910]	43210 [46910]	18080	
Fuerza de excavación del balancín	SAE	kN	180,4 [195,9]	156,9 [170,4]	131,4 [142,7]	114,7 [124,6]	47,1	
		kgf	18400 [19980]	16000 [17370]	13400 [14550]	11700 [12700]	4800	
		lbf	40570 [44050]	35270 [38290]	29540 [32070]	25790 [28000]	10580	
	ISO	kN	190,3 [206,6]	163,8 [177,8]	136,3 [148,0]	119,6 [129,9]	48,1	
		kgf	19400 [21060]	16700 [18130]	13900 [15090]	12200 [13250]	4900	
		lbf	42770 [46440]	36820 [39980]	30640 [33270]	26900 [29210]	10800	

Nota: El peso de la pluma incluye el cilindro del balancín, las tuberías y los bulones.
El peso del balancín incluye el cilindro de la cuchara, la articulación y los bulones.

DIMENSIONES Y RANGO DE TRABAJO

HX300 L

DIMENSIONES DEL HX300 L / HX300 NL

Pluma de 6,25 m (20' 6") y balancines de 2,1 m (6' 11"); 2,5 m (8' 2"); 3,05 m (10' 0") y 3,75 m (12' 4")

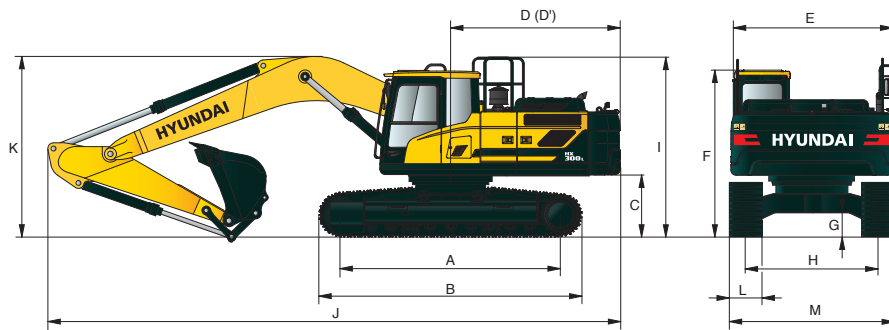

Unidad: mm (pies-pulg.)

A	Distancia de oscilación	4030 (13' 3")
B	Longitud total de la oruga	4940 (16' 2")
C	Distancia al suelo del contrapeso	1190 (3' 11")
D	Radio de giro trasero	3200 (10' 6")
D'	Longitud del extremo trasero	3120 (10' 3")
E	Ancho total de la superestructura	2980 (9' 9")
F	Altura total de la cabina	3030 (9' 11")
G	Distancia mínima al suelo	500 (1' 8")
H	Ancho de guía	HX300 L 2600 (8' 6")
		HX300 NL 2390 (7' 10")
I	Altura total de la barandilla protectora	3340 (10' 11")

Longitud de la pluma	6250 (20' 6")			
Longitud del balancín	2100 (6' 11")	2500 (8' 2")	3050 (10' 0")	3750 (12' 4")
J Longitud total	10700 (35' 1")	10650 (34' 11")	10560 (34' 8")	10630 (34' 11")
K Altura total de la pluma	3590 (11' 9")	3470 (11' 5")	3290 (10' 10")	3500 (11' 6")
L Ancho de la zapata de la oruga	600 (23' 6")			
M Ancho total	HX300 L:	3200 (10' 6")		
	HX300 NL:	2990 (9' 10")		

RANGO DE TRABAJO DEL HX300 L / HX300 NL

Unidad: mm (pies-pulg.)

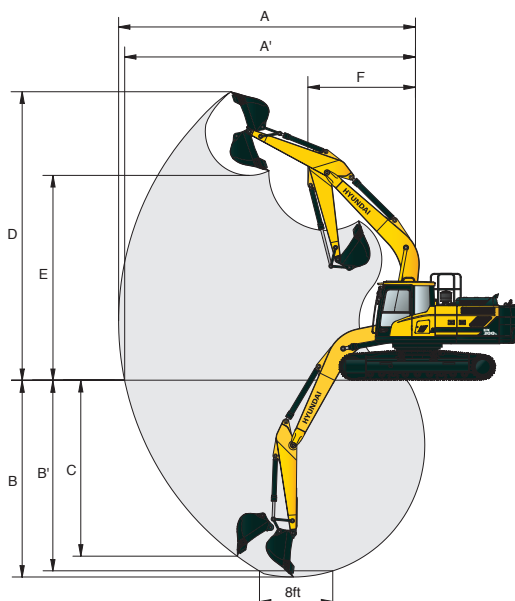

Longitud de la pluma	6250 (20' 6")			
Longitud del balancín	2100 (6' 11")	2500 (8' 2")	3050 (10' 0")	3750 (12' 4")
A Alcance de excavación máximo	10020 (32' 10")	10280 (33' 9")	10820 (35' 6")	11400 (37' 5")
A' Alcance de excavación máximo sobre tierra	9820 (32' 3")	10080 (33' 1")	10620 (34' 10")	11220 (36' 10")
B Profundidad de excavación máxima	6440 (21' 2")	6840 (22' 5")	7390 (24' 3")	8090 (26' 7")
B' Profundidad de excavación máxima (nivel de 8')	6240 (20' 6")	6630 (21' 9")	7200 (23' 7")	7920 (26' 0")
C Profundidad de excavación máxima en pared vertical	6000 (19' 8")	5850 (19' 2")	6380 (20' 11")	7080 (23' 3")
D Altura de excavación máxima	10040 (32' 11")	10000 (32' 10")	10160 (33' 4")	10360 (34' 0")
E Altura de descarga máxima	6940 (22' 9")	7030 (23' 1")	7110 (23' 4")	7310 (24' 0")
F Radio de giro delantero mínimo	4400 (14' 5")	4300 (14')	4250 (13' 11")	4200 (13' 9")

DIMENSIONES Y RANGO DE TRABAJO

HX300 L

DIMENSIONES DEL HX300 L ALCANCE LARGO (LONG REACH)

Pluma de 10,2 m (33' 6") y balancín de 7,85 m (25' 9")

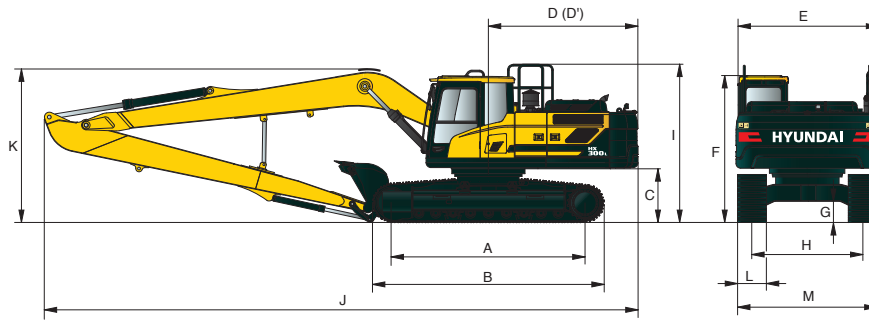

Unidad: mm (pies-pulg.)

A	Distancia de oscilación	4030 (13' 3")
B	Longitud total de la oruga	4940 (16' 2")
C	Distancia al suelo del contrapeso	1190 (3' 11")
D	Radio de giro trasero	3210 (10' 5")
D'	Longitud del extremo trasero	3120 (10' 3")
E	Ancho total de la superestructura	2980 (9' 9")
F	Altura total de la cabina	3030 (9' 11")
G	Distancia mínima al suelo	500 (1' 8")
H	Ancho de guía	2600 (8' 6")
I	Altura total de la barandilla protectora	3340 (10' 11")

	Longitud de la pluma	10200 (33' 6")
	Longitud del balancín	7850 (25' 9")
J	Longitud total	14560 (47' 9")
K	Altura total de la pluma	3560 (11' 8")
L	Ancho de la zapata de la oruga	800 (31' 5")
M	Ancho total	3400 (11' 2")

RANGO DE TRABAJO DEL HX300 L ALCANCE LARGO (LONG REACH)

Unidad: mm (pies-pulg.)

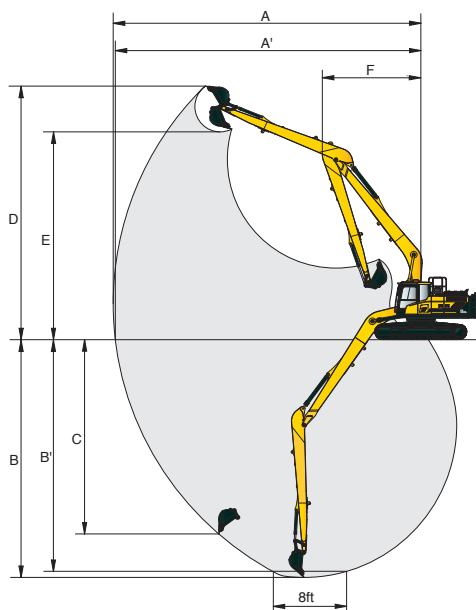

	Longitud de la pluma	10200 (33' 6")
	Longitud del balancín	7850 (25' 9")
A	Alcance de excavación máximo	18510 (60' 9")
A'	Alcance de excavación máximo sobre tierra	18400 (60' 4")
B	Profundidad de excavación máxima	14820 (48' 7")
B'	Profundidad de excavación máxima (nivel de 8')	14690 (48' 2")
C	Profundidad de excavación máxima en pared vertical	12020 (39' 5")
D	Altura de excavación máxima	14500 (47' 7")
E	Altura de descarga máxima	12190 (40' 0")
F	Radio de giro delantero mínimo	6250 (20' 6")

DIMENSIONES Y RANGO DE TRABAJO

HX300 L

DIMENSIONES DEL HX300 L BASTIDOR ALTO (HIGH WALKER)

Pluma de 6,25 m (20' 6") y balancín de 3,05 m (10' 0")

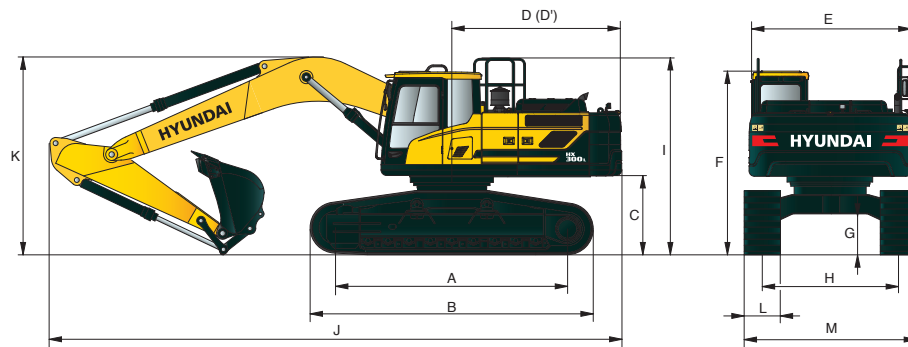

Unidad: mm (pies-pulg.)

A	Distancia de oscilación	4030 (13' 3")
B	Longitud total de la oruga	4950 (16' 3")
C	Distancia al suelo del contrapeso	1500 (4' 11")
D	Radio de giro trasero	3200 (10' 6")
D'	Longitud del extremo trasero	3120 (10' 3")
E	Ancho total de la superestructura	2980 (9' 9")
F	Altura total de la cabina	3400 (11' 2")
G	Distancia mínima al suelo	765 (2' 6")
H	Ancho de guía	2870 (9' 5")
I	Altura total de la barandilla protectora	3640 (12' 0")

Longitud de la pluma	6250 (20' 6")			
Longitud del balancín	2100 (6' 11")	2500 (8' 2")	3050 (10' 0")	3750 (12' 4")
J Longitud total	10690 (35' 1")	10610 (34' 10")	10430 (34' 3")	10530 (34' 7")
K Altura total de la pluma	3740 (12' 3")	3590 (11' 9")	3350 (11' 0")	3510 (11' 6")
L Ancho de la zapata de la oruga	600 (23' 6")			
M Ancho total	3470 (11' 5")			

RANGO DE TRABAJO DEL HX300 L BASTIDOR ALTO (HIGH WALKER)

Unidad: mm (pies-pulg.)

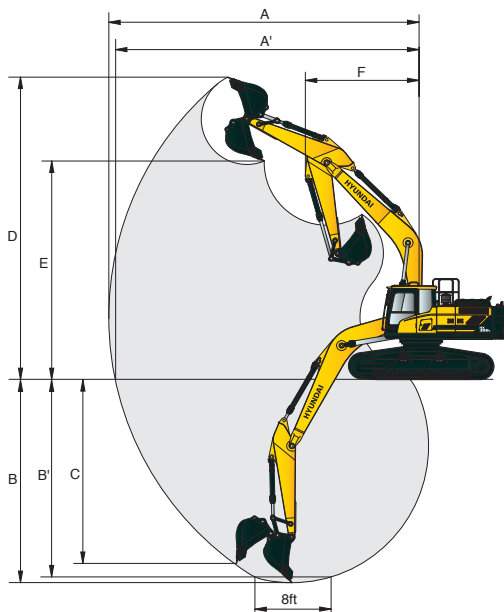

Longitud de la pluma	6250 (20' 6")			
Longitud del balancín	2100 (6' 11")	2500 (8' 2")	3050 (10' 0")	3750 (12' 4")
A Alcance de excavación máximo	10020 (32' 10")	10280 (33' 9")	10790 (35' 5")	11400 (37' 5")
A' Alcance de excavación máximo sobre tierra	9750 (32' 0")	10020 (32' 10")	10530 (34' 7")	11160 (36' 7")
B Profundidad de excavación máxima	6140 (20' 2")	6540 (21' 5")	7090 (23' 3")	7790 (25' 7")
B' Profundidad de excavación máxima (nivel de 8')	5930 (19' 5")	6330 (20' 9")	6910 (22' 8")	7630 (25' 0")
C Profundidad de excavación máxima en pared vertical	5700 (18' 8")	5560 (18' 3")	6090 (20' 0")	6790 (22' 3")
D Altura de excavación máxima	10320 (33' 10")	10270 (33' 8")	10440 (34' 3")	10660 (35' 0")
E Altura de descarga máxima	7240 (23' 9")	7170 (23' 6")	7400 (24' 3")	7610 (25' 0")
F Radio de giro delantero mínimo	4400 (14' 5")	4300 (14' 1")	4250 (13' 11")	4200 (13' 9")











CAPACIDAD DE ELEVACIÓN

HX300 L













 Capacidad nominal frontal  Capacidad nominal lateral o 360 grados

HX300 L













Pluma de 6,25 m (20' 6"); balancín de 2,10 m (6' 11"); equipado con una cuchara de 1,27 m³ (colmada SAE) y zapatas de triple garra de 600 mm (24").

Altura del punto de carga m (pies)	Radio de carga								Con alcance máx.		m (ft)	
	3.0 m (10 ft)		4.5 m (15 ft)		6.0 m (20 ft)		7.5 m (25 ft)		Capacidad			
												
7.5 m (25 ft)	kg											
	lb					*6130	*6130			*5630	4670	8.01
6.0 m (20 ft)	kg					*13510	*13510			*12410	10300	(26.3)
	lb					*6480	*6480	*6290	5050	*5730	3740	8.90
4.5 m (15 ft)	kg			*9540	*9540	*14290	*14290	*13870	11160	*12630	8250	(29.2)
	lb			*31030	*31030	*6630	7250	*14620	10890	5390	3260	9.42
3.0 m (10 ft)	kg			*12460	10480	*16560	15980	*7260	4720	5090	3040	9.64
	lb			*27470	23100	*8840	6770	*16010	10410	11220	6700	(31.6)
1.5 m (5 ft)	kg			*14460	9770	*10010	6370	7520	4510	5090	3020	9.58
	lb			*31880	21540	*22070	14040	16580	9940	11220	6660	(31.4)
Línea de tierra	kg			*15030	9560	10530	6140	7370	4370	5380	3200	9.23
	lb			*33140	21080	23210	13540	16250	9630	11860	7050	(30.3)
-1.5 m (-5 ft)	kg	*14310	*14310	*14720	9580	10460	6080	7340	4340	6110	3660	8.57
	lb	*31550	*31550	*32450	21120	23060	13400	16180	9570	13470	8070	(28.1)
-3.0 m (-10 ft)	kg	*18800	*18800	*13590	9760	*10100	6180			*6590	4710	7.47
	lb	*41450	*41450	*29960	21520	*22270	13620			*14530	10380	(24.5)
-4.5 m (-15 ft)	kg	*15160	*15160	*11050	10170							
	lb	*33420	*33420	*24360	22420							

Pluma de 6,25 m (20' 6"); balancín de 2,50 m (8' 2"); equipado con una cuchara de 1,27 m³ (colmada SAE) y zapatas de triple garra de 600 mm (24").

Altura del punto de carga m (pies)	Radio de carga								Con alcance máx.		m (ft)		
	1.5 m (5 ft)		3.0 m (10 ft)		4.5 m (15 ft)		6.0 m (20 ft)		7.5 m (25 ft)			Capacidad	
													
7.5 m (25 ft)	kg												
	lb										*5160	4390	
6.0 m (20 ft)	kg										*11380	9680	
	lb										*5320	3550	
4.5 m (15 ft)	kg					*8680	*8680	*7010	*7010	*6240	4980	5150	
	lb					*19140	*19140	*15450	*15450	*13760	10980	11350	
3.0 m (10 ft)	kg					*11600	10690	*8380	6840	*6930	4740	4860	
	lb					*25570	23570	*18470	15080	*15280	10450	10710	
1.5 m (5 ft)	kg					*13880	9850	*9660	6390	7520	4500	4840	
	lb					*30600	21720	*21300	14090	16580	9920	10670	
Línea de tierra	kg					*14840	9510	*10500	6110	7330	4340	5090	
	lb					*32720	20970	*23150	13470	16160	9570	11220	
-1.5 m (-5 ft)	kg			*15290	*15290	*14820	9460	10390	6010	7260	4270	5710	
	lb			*33710	*33710	*32670	20860	22010	13250	16010	9410	12590	
-3.0 m (-10 ft)	kg	*17300	*17300	*19910	*19910	*13960	9600	10310	6070			*6700	
	lb	*38140	*38140	*43890	*43890	*30780	21160	22730	13380			*14770	
-4.5 m (-15 ft)	kg			*16640	*16640	*11890	9950						
	lb			*36680	*36680	*26210	21940						

Pluma de 6,25 m (20' 6"); balancín de 3,05 m (10' 0"); equipado con una cuchara de 1,27 m³ (colmada SAE) y zapatas de triple garra de 600 mm (24").

Altura del punto de carga m (pies)	Radio de carga								Con alcance máx.		m (ft)		
	1.5 m (5 ft)		3.0 m (10 ft)		4.5 m (15 ft)		6.0 m (20 ft)		7.5 m (25 ft)			9.0 m (30 ft)	
													
7.5 m (25 ft)	kg												
	lb											*4690	
6.0 m (20 ft)	kg											*10340	
	lb											*4850	
4.5 m (15 ft)	kg							*6290	*6290	*5700	5020	4690	
	lb							*13870	*13870	*12570	11070	10340	
3.0 m (10 ft)	kg			*10560	*10560	*10410	*10410	*7710	6910	*6440	4750	*4350	
	lb			*23280	*23280	*22950	*22950	*17000	15230	*14200	10470	*9590	
1.5 m (5 ft)	kg					*13000	9970	*9100	6410	*7230	4480	*5160	
	lb					*28660	21980	*20060	14130	*15940	9880	*11380	
Línea de tierra	kg			*10210	*10210	*14420	9470	*10120	6070	7280	4280	*4530	
	lb			*22510	*22510	*31790	20880	*22310	13380	16050	9440	*9990	
-1.5 m (-5 ft)	kg	*11050	*11050	*14320	*14320	*14790	9310	10270	5900	7160	4170	5090	
	lb	*24360	*24360	*31570	*31570	*32610	20530	22640	13010	15790	9190	11220	
-3.0 m (-10 ft)	kg	*14950	*14950	*19330	*19330	*14280	9380	10270	5900	7180	4190	6120	
	lb	*32960	*32960	*42620	*42620	*31480	20680	22640	18010	15830	9240	13490	
-4.5 m (-15 ft)	kg	*19540	*19540	*18280	*18280	*12720	9640	*9280	6080			*6310	
	lb	*43080	*43080	*40300	*40300	*28040	21250	*20460	13400			*13910	

1. La capacidad de elevación se basa en SAE J1097 y en ISO 10567.

2. La capacidad de carga de la serie ROBEX no supera el 75 % de carga de vuelco con la máquina sobre una superficie firme y nivelada o con un 87 % de capacidad hidráulica total.

3. El punto de carga es un gancho ubicado en la parte posterior de la cuchara.

4. (*) indica carga limitada por capacidad hidráulica.















CAPACIDAD DE ELEVACIÓN

HX300 L

 Capacidad nominal frontal  Capacidad nominal lateral o 360 grados











HX300 L

Pluma de 6,25 m (20' 6"); balancín de 3,75 m (12' 4"); equipado con una cuchara de 1,27 m³ (colmada SAE) y zapatas de triple garra de 600 mm (24").













Altura del punto de carga m (pies)	Radio de carga												Con alcance máx.			
	1.5 m (5 ft)		3.0 m (10 ft)		4.5 m (15 ft)		6.0 m (20 ft)		7.5 m (25 ft)		9.0 m (30 ft)		Capacidad	Alcance		
															m (ft)	
7.5 m (25 ft)	kg												*4150	3330	9.67	
	lb												*9150	7340	(31.7)	
6.0 m (20 ft)	kg							*4400	*4400	*2470	*2470	*4320	2780	10.40		
	lb							*9700	*9700	*5450	*5450	*9520	6130	(34.1)		
4.5 m (15 ft)	kg							*4980	*4980	*3900	3580	4210	2460	10.83		
	lb							*10980	*10980	*8600	7890	9280	5420	(35.5)		
3.0 m (10 ft)	kg		*14350	*14350	*8830	*8830	*6800	*6800	*5800	4830	*5000	3430	3990	2290	11.02	
	lb		*31640	*31640	*19470	*19470	*14990	*14990	*12790	10650	*11020	7560	8800	5050	(36.2)	
1.5 m (5 ft)	kg		*10620	*10620	*11740	10310	*8340	6540	*6680	4520	5540	3260	3960	2250	10.97	
	lb		*23410	*23410	*25880	22730	*18390	14420	*14730	9960	12210	7190	8730	4960	(36.0)	
Línea de tierra	kg	*6900	*6900	*10970	*10970	*13710	9590	*9590	6120	7280	4270	5380	3120	4100	2320	10.68
	lb	*15210	*15210	*24180	*24180	*30230	21140	*21140	13490	16050	9410	11860	6880	9040	5110	(35.0)
-1.5 m (-5 ft)	kg	*9920	*9920	*13590	*13590	*14590	9280	10250	5870	7100	4110	5290	3030	4470	2560	10.12
	lb	*21870	*21870	*29960	*29960	*32170	20460	22600	12940	15650	9060	11660	6680	9850	5640	(33.2)
-3.0 m (-10 ft)	kg	*13080	*13080	*17280	*17280	*14560	9230	10160	5790	7050	4060			5220	3040	9.25
	lb	*28840	*28840	*38100	*38100	*32100	20350	22400	12760	15540	8950			11510	6700	(30.3)
-4.5 m (-15 ft)	kg	*16750	*16750	*20160	19820	*13580	9380	*9900	5870					*6130	4080	7.92
	lb	*36930	*36930	*44450	43700	*29940	20680	*21830	12940					*13510	8990	(26.0)

HX300 NL

Pluma de 6,25 m (20' 6"); balancín de 2,10 m (6' 11"); equipado con una cuchara de 1,27 m³ (colmada SAE) y zapatas de triple garra de 600 mm (24").

Altura del punto de carga m (pies)	Radio de carga								Con alcance máx.			
	3.0 m (10 ft)		4.5 m (15 ft)		6.0 m (20 ft)		7.5 m (25 ft)		Capacidad	Alcance		
											m (ft)	
7.5 m (25 ft)	kg					*6130	*6130			*5630	4210	8.01
	lb					*13510	*13510			*12410	9280	(26.3)
6.0 m (20 ft)	kg					*6480	*6480	*6290	4560	*5730	3350	8.90
	lb					*14290	*14290	*13870	10050	*12630	7390	(29.2)
4.5 m (15 ft)	kg		*9540	*9540	*7510	6540	*6630	4440		5350	2900	9.42
	lb		*21030	*21030	*16560	14420	*14620	9790		11790	6390	(30.9)
3.0 m (10 ft)	kg		*12460	9330	*8840	6070	*7260	4230		5050	2700	9.64
	lb		*27470	20570	*19490	13380	*16010	9330		11130	5950	(31.6)
1.5 m (5 ft)	kg		*14460	8650	*10010	5680	7460	4020		5040	2670	9.58
	lb		*31880	19070	*22070	12520	16450	8860		11110	5890	(31.4)
Línea de tierra	kg		*15030	8440	10450	5460	7310	3880		5330	2830	9.23
	lb		*33140	18610	23040	12040	16120	8550		11750	6240	(30.3)
-1.5 m (-5 ft)	kg	*14310	*14310	*14720	8460	10380	5400	7280	3860	6060	3260	8.57
	lb	*31550	*31550	*32450	18650	22880	11900	16050	8510	13360	7190	(28.1)
-3.0 m (-10 ft)	kg	*18800	17800	*13590	8640	*10100	5500			*6590	4210	7.47
	lb	*41450	39240	*29960	19050	*22270	12130			*14530	9280	(24.5)
-4.5 m (-15 ft)	kg	*15160	*15160	*11050	9030							
	lb	*33420	*33420	*24360	19910							

Pluma de 6,25 m (20' 6"); balancín de 2,50 m (8' 2"); equipado con una cuchara de 1,27 m³ (colmada SAE) y zapatas de triple garra de 600 mm (24").

Altura del punto de carga m (pies)	Radio de carga										Con alcance máx.		
	1.5 m (5 ft)		3.0 m (10 ft)		4.5 m (15 ft)		6.0 m (20 ft)		7.5 m (25 ft)		Capacidad	Alcance	
													m (ft)
7.5 m (25 ft)	kg										*5160	3960	8.34
	lb										*11380	8730	(27.4)
6.0 m (20 ft)	kg								*5800	4640	*5320	3170	9.19
	lb								*12790	10230	*11730	2990	(30.2)
4.5 m (15 ft)	kg			*8680	*8680	*7010	6630	*6240	4480		5110	2760	9.69
	lb			*19140	*19140	*15450	14620	*13760	9880		11270	6080	(31.8)
3.0 m (10 ft)	kg			*11600	9530	*8380	6140	*6930	4240		4830	2550	9.90
	lb			*25570	21010	*18470	13540	*15280	9350		10650	5620	(32.5)
1.5 m (5 ft)	kg			*13880	8720	*9660	5700	7460	4010		4800	2520	9.84
	lb			*30600	19220	*21300	12570	16450	8840		10580	5560	(32.3)
Línea de tierra	kg			*14840	8390	10430	5430	7280	3850		5040	2650	9.51
	lb			*32720	18500	22990	11970	16050	8490		11110	5840	(31.2)
-1.5 m (-5 ft)	kg		*15290	*15290	*14820	8350	10310	5330	7200	3780	5670	3010	8.87
	lb		*33710	*33710	*32670	18410	22730	11750	15870	8330	12500	6640	(29.1)
-3.0 m (-10 ft)	kg	*17300	*17300	*19910	17450	*13960	8480	*10310	5380		*6700	3810	7.82
	lb	*38140	*38140	*43890	38470	*30780	18700	*22730	11860		*14770	8400	(25.7)
-4.5 m (-15 ft)	kg			*16640	*16640	*11890	8810						
	lb			*36680	*36680	*26210	19420						















CAPACIDAD DE ELEVACIÓN

HX300 L















 Capacidad nominal frontal  Capacidad nominal lateral o 360 grados

HX300 NL

Pluma de 6,25 m (20' 6"); balancín de 3,05 m (10' 0"); equipado con una cuchara de 1,27 m³ (colmada SAE) y zapatas de triple garra de 600 mm (24").

Altura del punto de carga m (pies)	Radio de carga										Con alcance máx.				
	1.5 m (5 ft)		3.0 m (10 ft)		4.5 m (15 ft)		6.0 m (20 ft)		7.5 m (25 ft)		9.0 m (30 ft)		Capacidad	Alcance	
															m (ft)
7.5 m (25 ft)	kg												*4690	3480	8.94
	lb												*10340	7670	(29.3)
6.0 m (20 ft)	kg								*5190	4720			*4850	2830	9.74
	lb								*11440	10410			*10690	6240	(32.0)
4.5 m (15 ft)	kg														
	lb								*6290	*6290	*5700	4520			
									*13870	*13870	*12570	9960			
													4660	2470	10.20
													10270	5450	(33.5)
3.0 m (10 ft)	kg		*10560	*10560	*10410	9790	*7710	6200	*6440	4250	*4350	3010	4410	2290	10.40
	lb		*23280	*23280	*22950	21580	*17000	13670	*14200	9370	*9590	6640	9720	5050	(34.1)
1.5 m (5 ft)	kg				*13000	8840	*9100	5720	*7230	3990	*5160	2880	4370	2240	10.35
	lb				*28660	19490	*20060	12610	*15940	8800	*11380	6350	9630	4940	(34.0)
Línea de tierra	kg		*10210	*10210	*14420	8350	*10120	5380	7220	3790	*4530	2780	4560	2340	10.04
	lb		*22510	*22510	*31790	18410	*22310	11860	15920	8360	*9990	6130	10050	5160	(32.9)
-1.5 m (-5 ft)	kg	*11050	*11050	*14320	*14320	*14790	8200	10200	5220	7100	3680		5050	2620	9.44
	lb	*24360	*24360	*31570	*31570	*32610	18080	22490	11510	15650	8110		11130	5780	(31.0)
-3.0 m (-10 ft)	kg	*14950	*14950	*19330	17000	*14280	8260	10190	5220	7120	3700		6080	3220	8.48
	lb	*32960	*32960	*42620	37480	*31480	18210	22470	11510	15700	8160		13400	7100	(27.8)
-4.5 m (-15 ft)	kg	*19540	*19540	*18280	17510	*12720	8510	*9280	5400				*6310	4650	6.97
	lb	*43080	*43080	*40300	38600	*28040	18760	*20460	11900				*13910	10250	(22.9)

Pluma de 6,25 m (20' 6"); balancín de 3,75 m (12' 4"); equipado con una cuchara de 1,27 m³ (colmada SAE) y zapatas de triple garra de 600 mm (24").

Altura del punto de carga m (pies)	Radio de carga										Con alcance máx.					
	1.5 m (5 ft)		3.0 m (10 ft)		4.5 m (15 ft)		6.0 m (20 ft)		7.5 m (25 ft)		9.0 m (30 ft)		Capacidad	Alcance		
															m (ft)	
7.5 m (25 ft)	kg												*4150	2980	9.67	
	lb												*9150	6570	(31.7)	
6.0 m (20 ft)	kg								*4400	*4400	*2470	*2470	*4320	2460	10.40	
	lb								*9700	*9700	*5450	*5450	*9520	5420	(34.1)	
4.5 m (15 ft)	kg															
	lb								*4980	4620	*3900	3200	4170	2160	10.83	
									*10980	10190	*8600	7050	9190	4760	(35.5)	
3.0 m (10 ft)	kg		*14350	*14350	*8830	*8830	*6800	6380	*5800	4330	*5000	3040	3960	2000	11.02	
	lb		*31640	*31640	*19470	*19470	*14990	14070	*12790	9550	*11020	6700	8730	4410	(36.2)	
1.5 m (5 ft)	kg		*10620	*10620	*11740	9160	*8340	5840	*6680	4030	5490	2880	3920	1950	10.97	
	lb		*23410	*23410	*25880	20190	*18390	12870	*14730	8880	12100	6350	8640	4300	(36.0)	
Línea de tierra	kg	*6900	*6900	*10970	*10970	*13710	8470	*9590	5430	7230	3780	5340	4060	2020	10.68	
	lb	*15210	*15210	*24180	*24180	*30230	18670	*21140	11970	15940	8330	11770	6040	8950	4450	(35.0)
-1.5 m (-5 ft)	kg	*9920	*9920	*13590	*13590	*14590	8160	10170	5180	7050	3620	5250	2660	4430	2230	10.12
	lb	*21870	*21870	*29960	*29960	*32170	17990	22420	11420	15540	7980	11570	5860	9770	4920	(33.2)
-3.0 m (-10 ft)	kg	*13080	*13080	*17280	16650	*14560	8110	10080	5110	6990	3570		5180	2670	9.25	
	lb	*28840	*28840	*38100	36710	*32100	17880	22220	11270	15410	7870		11420	5890	(30.3)	
-4.5 m (-15 ft)	kg	*16750	*16750	*20160	17050	*13580	8260	*9900	5190				*6130	3620	7.92	
	lb	*36930	*36930	*44450	37590	*29940	18210	*21830	11440				*13510	7980	(26.0)	

1. La capacidad de elevación se basa en SAE J1097 y en ISO 10567.
2. La capacidad de carga de la serie ROBEX no supera el 75 % de carga de vuelco con la máquina sobre una superficie firme y nivelada o con un 87 % de capacidad hidráulica total.

3. El punto de carga es un gancho ubicado en la parte posterior de la cuchara.
4. (*) indica carga limitada por capacidad hidráulica.















CAPACIDAD DE ELEVACIÓN

HX300 L

 Capacidad nominal frontal  Capacidad nominal lateral o 360 grados









HX300 L ALCANCE LARGO (LONG REACH)

Pluma de 10,2 m (33' 6"); balancín de 7,85 m (25' 9"); equipado con una cuchara de 0,52 m³ (colmada SAE) y zapatas de triple garra de 800 mm (32")

Altura del punto de carga m (pies)	Radio de carga										Con alcance máx.							
	6.0 m (20 ft)		7.5 m (25 ft)		9.0 m (30 ft)		10.5 m (35 ft)		12.0 m (40 ft)		13.5 m (45 ft)		15.0 m (50 ft)		Capacidad	Alcance		
																m (ft)		
13.5 m (45 ft)	kg														*1780	*1780	14.13	
	lb														*3920	*3920	(46.4)	
12.0 m (40 ft)	kg														*1800	*1800	15.27	
	lb														*3970	*3970	(50.1)	
10.5 m (35 ft)	kg												*1060	*1060	*1840	1800	16.18	
	lb												*2340	*2340	*4060	3970	(53.1)	
9.0 m (30 ft)	kg												*1520	*1520	*1880	1580	16.89	
	lb												*3350	*3350	*4140	3480	(55.4)	
7.5 m (25 ft)	kg										*1900	*1900	*1830	*1830	*1930	1410	17.44	
	lb										*4190	*4190	*4030	*4030	*4250	3110	(57.2)	
6.0 m (20 ft)	kg										*2050	*2050	*2030	1990	*1990	1290	17.83	
	lb										*4520	*4520	*4480	4390	*4390	2840	(58.5)	
4.5 m (15 ft)	kg								*2350	*2350	*2230	*2230	*2160	1900	*2060	1190	18.08	
	lb								*5180	*5180	*4920	*4920	*4760	4190	*4540	2620	(59.3)	
3.0 m (10 ft)	kg					*3280	*3280	*2900	*2900	*2630	*2630	*2440	2270	*2310	1800	2100	1130	18.20
	lb					*7230	*7230	*6390	*6390	*5800	*5800	*5380	5000	*5090	3970	4630	2490	(59.7)
1.5 m (5 ft)	kg	*6200	*6200	*4720	*4720	*3860	*3860	*3310	*3310	*2930	2650	*2660	2120	*2470	1700	2060	1090	18.19
	lb	*13670	*13670	*10410	*10410	*8510	*8510	*7300	*7300	*6460	5840	*5860	4670	*5450	3750	4540	2400	(59.7)
Línea de tierra	kg	*7360	6790	*5500	5030	*4410	3880	*3700	3070	*3220	2460	*2880	1990	*2630	1610	2060	1070	18.04
	lb	*16230	14970	*12130	11090	*9720	8550	*8160	6770	*7100	5420	*6350	4390	*5800	3550	4540	2360	(59.2)
-1.5 m (-5 ft)	kg	*8210	6230	*6140	4620	*4880	3580	*4060	2850	*3490	2300	*3090	1870	2750	1520	2080	1080	17.76
	lb	*18100	13730	*13540	10190	*10760	7890	*8950	6280	*7690	5070	*6810	4120	6060	3350	4590	2380	(58.3)
-3.0 m (-10 ft)	kg	*8750	5910	*6610	4340	*5260	3360	*4360	2680	*3720	2170	3180	1770	2680	1460	2150	1120	17.33
	lb	*19290	13030	*14570	9570	*11600	7410	*9610	5910	*8200	4780	7010	3900	5910	3220	4740	2470	(56.9)
-4.5 m (-15 ft)	kg	*9050	5760	*6910	4180	*5530	3220	4520	2560	3710	2080	3110	1710	2640	1420	2270	1200	16.75
	lb	*19950	12700	*15230	9220	*12190	7100	9960	5640	8180	4590	6860	3770	5820	3130	5000	2650	(55.0)
-6.0 m (-20 ft)	kg	*9130	5730	*7050	4120	5580	3150	4450	2500	3660	2030	3080	1680	2640	1410	2450	1310	15.99
	lb	*20130	12630	*15540	9080	12300	6940	9810	5510	8070	4480	6790	3700	5820	3110	5400	2890	(52.5)
-7.5 m (-25 ft)	kg	*9010	5790	*7040	4130	5570	3150	4450	2490	3660	2030	3090	1690			2720	1500	15.04
	lb	*19860	12760	*15520	9110	12280	6940	9810	5490	8070	4480	6810	3730			6000	3310	(49.3)
-9.0 m (-30 ft)	kg	*8670	5930	*6840	4220	*5570	3200	4500	2540	3720	2080					*3100	1780	13.83
	lb	*19110	13070	*15080	9300	*12280	7050	9920	5600	8200	4590					*6830	3920	(45.4)
-10.5 m (-35 ft)	kg	*8060	6160	*6410	4380	*5220	3330	*4310	2660	*3530	2210					*3270	2250	12.31
	lb	*17770	13580	*14130	9660	*11510	7340	*9500	5860	*7780	4870					*7210	4960	(40.4)
-12.0 m (-40 ft)	kg	*7070	6490	*5640	4630	*4550	3550											
	lb	*15590	14310	*12430	10210	*10030	7830											
-13.5 m (-45 ft)	kg	*5460	*5460	*4260	*4260													
	lb	*12040	*12040	*9390	*9390													

HX300 L BASTIDOR ALTO (HIGH WALKER)

Pluma de 6,25 m (20' 6"); balancín de 2,10 m (6' 11"); equipado con una cuchara de 1,27 m³ (colmada SAE) y zapatas de triple garra de 600 mm (24").

Altura del punto de carga m (pies)	Radio de carga						Con alcance máx.					
	3.0 m (10 ft)		4.5 m (15 ft)		6.0 m (20 ft)		7.5 m (25 ft)		Capacidad	Alcance		
										m (ft)		
7.5 m (25 ft)	kg					*6120	*6120		*5650	5540	8.21	
	lb					*13490	*13490		*12460	12210	(26.9)	
6.0 m (20 ft)	kg					*6640	*6640	*6310	6300	*5760	4580	9.02
	lb					*14640	*14640	*13910	13890	*12700	10100	(29.6)
4.5 m (15 ft)	kg			*10090	*10090	*7750	*7750	*6730	6140	*5920	4100	9.48
	lb			*22240	*22240	*17090	*17090	*14840	13540	*13050	9040	(31.1)
3.0 m (10 ft)	kg			*12960	*12960	*9080	8400	*7390	5910	5850	3900	9.65
	lb			*28570	*28570	*20020	18520	*16290	13030	12900	8600	(31.7)
1.5 m (5 ft)	kg			*14660	12420	*10190	8020	*8000	5710	5910	3930	9.53
	lb			*32320	27380	*22470	17680	*17640	12590	13030	8660	(31.3)
Línea de tierra	kg			*15030	12260	*10780	7810	*8360	5580	6310	4200	9.13
	lb			*33140	27030	*23770	17220	*18430	12300	13910	9260	(30.0)
-1.5 m (-5 ft)	kg	*15990	*15990	*14580	12320	*10740	7780	*8220	5580	*6690	4860	8.40
	lb	*35250	*35250	*32140	27160	*23680	17150	*18120	12300	*14750	10710	(27.6)
-3.0 m (-10 ft)	kg	*18280	*18280	*13250	12540	*9820	7920			*6510	6350	7.20
	lb	*40300	*40300	*29210	27650	*21650	17460			*14350	14000	(23.6)
-4.5 m (-15 ft)	kg	*14130	*14130	*10250	*10250							
	lb	*31150	*31150	*22600	*22600							

- La capacidad de elevación se basa en SAE J1097 y en ISO 10567.
- La capacidad de carga de la serie ROBEX no supera el 75 % de carga de vuelco con la máquina sobre una superficie firme y nivelada o con un 87 % de capacidad hidráulica total.

- El punto de carga es un gancho ubicado en la parte posterior de la cuchara.
- (*) indica carga limitada por capacidad hidráulica.













CAPACIDAD DE ELEVACIÓN

HX300 L













 Capacidad nominal frontal  Capacidad nominal lateral o 360 grados

HX300 L BASTIDOR ALTO (HIGH WALKER)













Pluma de 6,25 m (20' 6"); balancín de 2,50 m (8' 2"); equipado con una cuchara de 1,27 m³ (colmada SAE) y zapatas de triple garra de 600 mm (24").

Altura del punto de carga m (pies)	Radio de carga										Con alcance máx.			
	1.5 m (5 ft)		3.0 m (10 ft)		4.5 m (15 ft)		6.0 m (20 ft)		7.5 m (25 ft)		Capacidad	Alcance		
													m (ft)	
7.5 m (25 ft)	kg										*5190	*5190	8.53	
	lb										*11440	*11440	(28.0)	
6.0 m (20 ft)	kg						*6120	*6120	*5850	*5850	*5350	4370	9.31	
	lb						*13490	*13490	*12900	*12900	*11790	9630	(30.5)	
4.5 m (15 ft)	kg			*9210	*9210	*7260	*7260	*6360	6180		*5560	3920	9.75	
	lb			*20300	*20300	*16010	*16010	*14020	13620		*12260	8640	(32.0)	
3.0 m (10 ft)	kg			*12120	*12120	*8640	8460	*7070	5930		5520	3720	9.91	
	lb			*26720	*26720	*19050	18650	*15590	13070		12170	8200	(32.5)	
1.5 m (5 ft)	kg			*14160	12480	*9860	8030	*7750	5690		5550	3730	9.80	
	lb			*31220	27510	*21740	17700	*17090	12540		12240	8220	(32.2)	
Línea de tierra	kg		*10190	*10190	*14910	12200	*10600	7780	*8220	5540	5890	3960	9.42	
	lb		*22470	*22470	*32870	26900	*23370	17150	*18120	12210	12990	8730	(30.9)	
-1.5 m (-5 ft)	kg	*13120	*13120	*16490	*16490	*14720	12190	*10740	7700	8240	5500	*6590	4520	8.71
	lb	*28920	*28920	*36350	*36350	*32450	26870	*23680	16980	18170	12130	*14530	9960	(28.6)
-3.0 m (-10 ft)	kg	*18380	*18380	*19430	*19430	*13680	12370	*10110	7790			*6690	5760	7.57
	lb	*40520	*40520	*42840	*42840	*30160	27270	*22290	17170			*14750	12700	(24.8)
-4.5 m (-15 ft)	kg			*15750	*15750	*11270	*11270							
	lb			*34720	*34720	*24850	*24850							

Pluma de 6,25 m (20' 6"); balancín de 3,05 m (10' 0"); equipado con una cuchara de 1,27 m³ (colmada SAE) y zapatas de triple garra de 600 mm (24").

Altura del punto de carga m (pies)	Radio de carga										Con alcance máx.				
	1.5 m (5 ft)		3.0 m (10 ft)		4.5 m (15 ft)		6.0 m (20 ft)		7.5 m (25 ft)		9.0 m (30 ft)		Capacidad	Alcance	
														m (ft)	
7.5 m (25 ft)	kg							*3490	*3490				*4720	4650	9.12
	lb							*7690	*7690				*10410	10250	(29.9)
6.0 m (20 ft)	kg							*5260	*5260				*4890	3940	9.85
	lb							*11600	*11600				*10780	8690	(32.3)
4.5 m (15 ft)	kg					*6540	*6540	*5830	*5830	*3060	*3060		*5090	3560	10.26
	lb					*14420	*14420	*12850	*12850	*6750	*6750		*11220	7850	(33.7)
3.0 m (10 ft)	kg			*10970	*10970	*7990	*7990	*6600	5940	*4570	4330		5060	3380	10.41
	lb			*24180	*24180	*17610	*17610	*14550	13100	*10080	9550		11160	7450	(34.2)
1.5 m (5 ft)	kg		*7330	*7330	*13360	12580	*9330	8040	*7370	5670	*5190	4200	5070	3370	10.31
	lb		*16160	*16160	*29450	27730	*20570	17730	*16250	12500	*11440	9260	11180	7430	(33.8)
Línea de tierra	kg		*10950	*10950	*14560	12130	*10260	7720	*7950	5470			5340	3550	9.95
	lb		*24140	*24140	*32100	26740	*22620	17020	*17530	12060			11770	7830	(32.6)
-1.5 m (-5 ft)	kg	*11760	*11760	*15190	*15190	*14760	12020	*10630	7580	8120	5380		5970	3990	9.29
	lb	*25930	*25930	*33490	*33490	*32540	26500	*23440	16710	17900	11860		13160	8800	(30.5)
-3.0 m (-10 ft)	kg	*15750	*15750	*20440	*20440	*14070	12120	*10310	7610	*7790	5440		*6360	4910	8.24
	lb	*34720	*34720	*45060	*45060	*31020	26720	*22730	16780	*17170	11990		*14020	10820	(27.0)
-4.5 m (-15 ft)	kg	*20530	*20530	*17540	*17540	*12250	*12250	*8860	7850						
	lb	*45260	*45260	*38670	*38670	*27010	*27010	*19530	17310						

Pluma de 6,25 m (20' 6"); balancín de 3,75 m (12' 4"); equipado con una cuchara de 1,27 m³ (colmada SAE) y zapatas de triple garra de 600 mm (24").

Altura del punto de carga m (pies)	Radio de carga										Con alcance máx.					
	1.5 m (5 ft)		3.0 m (10 ft)		4.5 m (15 ft)		6.0 m (20 ft)		7.5 m (25 ft)		9.0 m (30 ft)		Capacidad	Alcance		
														m (ft)		
7.5 m (25 ft)	kg												*4180	4070	9.83	
	lb												*9220	8970	(32.3)	
6.0 m (20 ft)	kg							*4480	*4480	*2810	*2810		*4350	3500	10.50	
	lb							*9880	*9880	*6190	*6190		*9590	7720	(34.4)	
4.5 m (15 ft)	kg							*5120	*5120	*4120	*4120		*4560	3170	10.89	
	lb							*11290	*11290	*9080	*9080		*10050	6990	(35.7)	
3.0 m (10 ft)	kg		*15870	*15870	*9420	*9420	*7100	*7100	*5960	*5960	*5200	4360	4570	3020	11.03	
	lb		*34990	*34990	*20770	*20770	*15650	*15650	*13140	*13140	*11460	9610	10080	6660	(36.2)	
1.5 m (5 ft)	kg		*10310	*10310	*12200	*12200	*8600	8160	*6840	5710	*5860	4190	4570	3000	10.93	
	lb		*22730	*22730	*26900	*26900	*18960	17990	*15080	12590	*12920	9240	10080	6610	(35.9)	
Línea de tierra	kg	*7490	*7490	*11370	*11370	*13960	12230	*9770	7750	*7580	5460	6130	4060	4770	3130	10.59
	lb	*16510	*16510	*25070	*25070	*30780	26960	*21540	17090	*16710	12040	13510	8950	10520	6900	(34.7)
-1.5 m (-5 ft)	kg	*10490	*10490	*14210	*14210	*14650	11960	*10420	7530	*8020	5320	*5010	3990	5250	3460	9.98
	lb	*23130	*23130	*31330	*31330	*32300	26370	*22970	16600	*17680	11730	*11050	8800	11570	7630	(32.7)
-3.0 m (-10 ft)	kg	*13730	*13730	*18110	*18110	*14450	11950	*10460	7480	*7990	5290			*5950	4140	9.03
	lb	*30270	*30270	*39930	*39930	*31860	26350	*23060	16490	*17610	11660			*13120	9130	(29.6)
-4.5 m (-15 ft)	kg	*17530	*17530	*19590	*19590	*13260	12160	*9660	7600					*6140	5610	7.60
	lb	*38650	*38650	*43190	*43190	*29230	26810	*21300	16760					*13540	12370	(24.9)

1. La capacidad de elevación se basa en SAE J1097 y en ISO 10567.

2. La capacidad de carga de la serie ROBEX no supera el 75 % de carga de vuelco con la máquina sobre una superficie firme y nivelada o con un 87 % de capacidad hidráulica total.

3. El punto de carga es un gancho ubicado en la parte posterior de la cuchara.

4. (*) indica carga limitada por capacidad hidráulica.

MOTOR	STD	OPT
Motor Cummins QSB 6.7	●	
SISTEMA HIDRÁULICO		
Control de potencia inteligente (IPC)		
Modo de usuario, 2 modos de trabajo, 3 modos de potencia	●	
Control de potencia variable	●	
Control de flujo de la bomba	●	
Control de flujo del modo de accesorios		●
Ralentí automático del motor	●	
Control de desconexión automática del motor		●
Control del ventilador electrónico	●	
CABINA E INTERIOR		
Cabina según las normas ISO		
Limpiaparabrisas de tipo elevación	●	
Reproductor USB/radio	●	
Sistema telefónico portátil manos libres con USB	●	
Salida de potencia de 12 voltios (convertidor de 24 V CC a 12 V CC)	●	
Claxon eléctrico	●	
Cabina de acero para todas las estaciones con visibilidad de 360°	●	
Ventanas con cristal de seguridad	●	
Ventanilla delantera plegable deslizante	●	
Ventanilla lateral deslizante (IZQ)	●	
Puerta bloqueable	●	
Nevera y termo	●	
Compartimento de almacenamiento y cenicero	●	
Cubierta del techo de la cabina transparente	●	
Visera parasol	●	
Cerraduras en cabina y puerta, una llave	●	
Asiento con suspensión mecánica con calefacción	●	
Palanca de mando deslizante accionada por piloto	●	
Sistema de ajuste de la altura de la consola	●	
Climatizador automático		
Aire acondicionado y calefacción	●	
Desempañador	●	
Asistencia al arranque (radiador de rejilla de aire) para climas fríos	●	
Supervisión centralizada		
Pantalla LCD de 8"	●	
Aceleración/cuentakilómetros parcial o régimen del motor	●	
Indicador de temperatura del refrigerante del motor	●	
Potencia máxima	●	
Velocidad baja/velocidad alta	●	
Ralentí automático	●	
Sobrecarga	●	
Revisión del motor	●	
Obstrucción del filtro de aire	●	
Indicadores	●	
Indicadores ECO	●	
Indicador de nivel de combustible	●	
Indicador de temperatura del aceite hidráulico	●	
Calentador de combustible	●	
Advertencias	●	
Error de comunicación	●	
Batería baja	●	
Reloj	●	
Luces de cabina	●	
Protección contra lluvia en la ventanilla delantera de la cabina		●
Cubierta de acero para el techo de la cabina		●
Asiento		
Asiento con suspensión neumática ajustable y calefacción		●
Cabina FOPS/FOG (ISO/DIS 10262) de Nivel 2		
FOPS (Estructura de protección anticaída de objetos) - ISO 3449 Nivel 2		●
FOG (Protección anticaída de objetos)		●
Cabina ROPS (ISO 12117-2)		
ROPS (Estructura protectora en caso de vuelco)	●	

SEGURIDAD	STD	OPT
Interruptor principal de la batería	●	
Cámara de visión trasera	●	
AAVM (Supervisión de visión periférica avanzada)		●
Cuatro luces de trabajo delanteras	●	
Alarma de desplazamiento	●	
Luz de trabajo posterior		●
Luz de baliza rotativa		●
Freno de giro automático	●	
Sistema de sujeción de la pluma	●	
Sistema de sujeción del balancín	●	
Válvula de bloqueo de seguridad del cilindro de la pluma con dispositivo de advertencia de sobrecarga	●	
Válvula de bloqueo de seguridad del cilindro del balancín		●
Sistema de bloqueo de giro		●
Tres espejos retrovisores exteriores	●	
OTROS		
Plumas		
6,25 m; 20' 6"	●	
10,2 m; 33' 6" Alcance largo (long reach)		●
Balancines		
2,1 m; 6' 11"		●
2,5 m; 8' 2"		●
3,05 m; 10' 0"	●	
3,75 m; 12' 4"		●
7,85 m; 25' 9" Alcance largo (long reach)		●
Malla antipolvo extraíble para el enfriador	●	
Depósito extraíble	●	
Prefiltro de combustible	●	
Calentador de combustible	●	
Sistema de autodiagnóstico	●	
Hi-mate (Sistema de gestión remota)	●	
Baterías (2 x 12 V x 160 Ah)	●	
Bomba de llenado de combustible (50 l/min)	●	
Kit de tuberías de única acción (interruptor, etc.)		●
Kit de tuberías de doble acción (cuchara, etc.)	●	
Kit de tuberías de rotación		●
Tubo de acoplamiento rápido		●
Acoplamiento rápido		●
Control de flotación de la pluma		●
Sistema de desplazamiento recto de un pedal		●
Acumulador para descenso del equipo de trabajo	●	
Patrón de válvula de cambio (2 patrones)		●
Sistema de control de giro fino		●
Kit de herramientas		●
TREN DE RODAJE		
Cubierta baja del bastidor inferior (adicional)		●
Cubierta baja del bastidor inferior (normal)	●	
Zapatas de las orugas		
Zapatas de triple garra (600 mm; 24")	●	
Zapatas de triple garra (700 mm; 28")		●
Zapatas de triple garra (800 mm; 32")		●
Zapatas de triple garra (900 mm; 36")		●
Zapatas de doble garra (700 mm; 28")		●
Barandilla protectora en la oruga	●	
Barandilla protectora total en la oruga		●

STD = Estándar
OPT = Opcional

- * El equipamiento estándar y opcional pueden variar. Póngase en contacto con su distribuidor de Hyundai para obtener más información. La máquina puede variar según los estándares internacionales.
- * Las fotos pueden contener accesorios y equipamiento opcional que no estén disponibles en su región.
- * Los materiales y las especificaciones están sujetos a cambios sin previo aviso.
- * Todas las medidas imperiales han sido redondeadas a la libra o pulgada más próxima.