

EPOMINI



EpoMini 20



EpoMini 5



– de-icing of roads!

EPOMINI

Technical data and dimensions

	EpoMini 5	EpoMini 20
Hopper capacity:	app. 50 liters	app. 200 liters
Spreading width:	550 mm	800 mm
Total width:	760 mm	1065 mm
Weight:	30 kg	75 kg
Cruising radius per filling		
Salt:	app. 5 km	app. 15 km
Sand:	app. 1 km	app. 2-3 km
Standard equipment:	Agitator, rubber base, spring base adjustment, transmission and wheels.	

Features:

EpoMini is equipped with the Epoke metering system consisting of an impellor, a delivery roller and a spring loaded rubber base which ensure an accurate and homogeneous distribution along the full width of the spreader.

Like all other Epoke machines, EpoMini features surface treatment consisting of sandblasting, zinc dust priming, 2-component polyurethane base coat and a 2-component top coat.

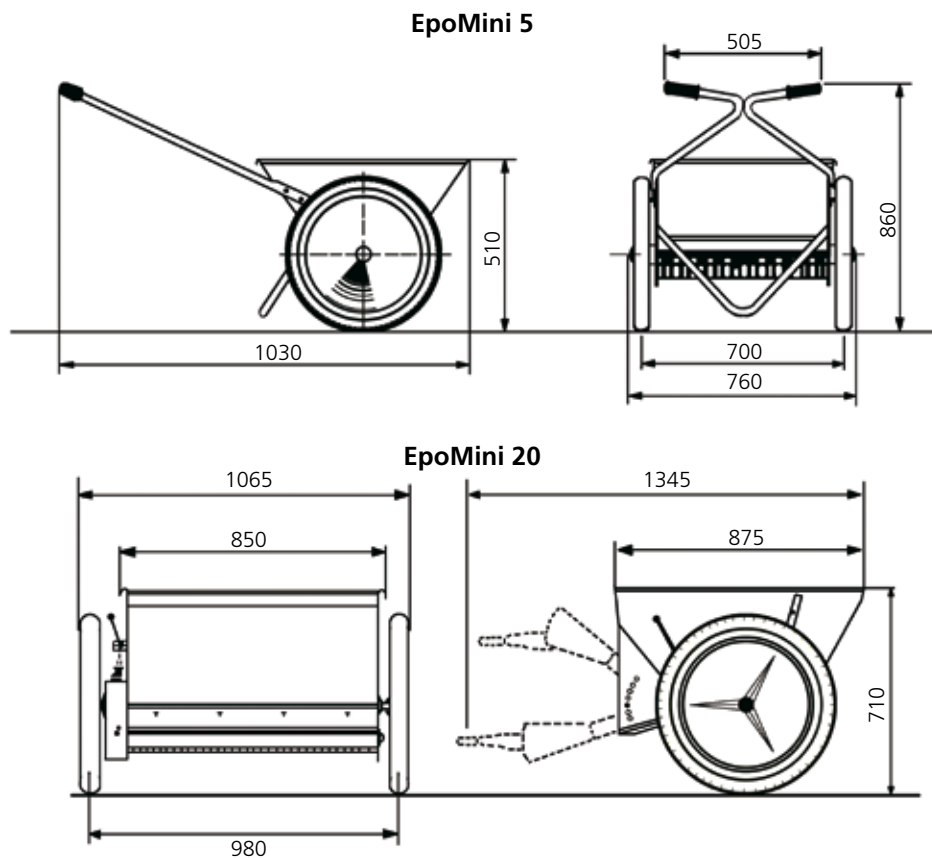

Epoke® A/S
 Vejervej 50, Askov
 DK-6600 Vejen
 Tel. +45 76 96 22 00
 Fax +45 75 36 38 67
 epoke@epoke.dk
 www.epoke.dk



In order to maintain the high and uniform product standard Epoke® A/S has been certified by Lloyd's register to ISO 9001:2000.
 TLG B-3 approval
 GS approval
 E1 approval
 RoHS directive
 WEEE directive

