

* | 102 kW (137 HP) at 2000 rpm

▲ | 15677 - 16762 kg

📦 | 0.24 - 0.76 m³



DX160W-3 | Wheeled Excavator



DX160W-3



Take a tour	pages 4 - 5
Performance	pages 6 - 7
Comfort	pages 8 - 9
Control	pages 10 - 11
Reliability	pages 12 - 13
Maintenance	pages 14 - 15
Technical specifications	pages 16 - 17
Dimensions and working range	pages 18 - 19
Lifting capacities	pages 20 - 22
Equipment	page 23

EXCELLENCE IN PERFORMANCE & CONTROL



DOES YOUR MACHINE MEET YOUR LONG-TERM NEEDS?

The new DX160W-3 is strong and robust enough to tackle your most demanding jobs, exceptionally stable, highly mobile and yet easy on the environment and your pocket. Keep profits up and costs down with a range of new features such as:

- A **new** generation Stage IIIB-compliant **engine**. Benefit from strong, responsive **power** with **reduced fuel consumption** and emissions
- **Top quality materials** and components. Count on long-term reliability and maximum uptime
- A brand new fully-featured, ergonomically designed **ROPS cab**. Work in top-class **comfort** with excellent all-round **visibility**
- The ultimate combination of **strength, stability** and **versatility**. A real return on your investment!

TAKE A TOUR

Large, heavy-duty boom and arm cylinders for smooth, powerful operation

New work lights with improved illumination (standard: 2 front frame, 4 front & 2 rear cab-mounted, 2 boom mounted and 1 rear side)

Reinforced castings and forged steel pivot points



Massive maximum bucket and arm digging forces of 11.7 and 8.1 t

Reinforced heavy-duty arm and boom with optional new boom floating system

All-round visibility with better view through the rear and right windows



EXPERT CONTROL

- Forward - Neutral - Reverse switch on the right joystick
- 4 speeds (high, eco, low, creep) with cruise control
- Jog shuttle switch to control various machine functions
- 4 working modes and 4 power modes for maximum efficiency
- As standard, hydraulic flow and pressure adjustable from the cab with 10 attachment presets
- Proportional control of auxiliary hydraulics to operate attachments smoothly and precisely
- New, user-friendly 7" TFT LCD colour monitor with full access to machine settings and maintenance data
- Rear camera and large side mirrors (side camera optional)
- 3 front axle oscillation lock modes (On/Off/Auto)

Excellent ground clearance for better protection in rough terrain

Reliable and well protected hydraulic, electric and lubrication routings with simple, optimised layout

COMFORTABLE WORKSPACE

- Spacious, newly designed, pressurised ROPS cab with low noise and vibration levels
- Fully adjustable heated air suspension seat as standard
- Large sun roof for extra overhead visibility
- Air conditioning with climate control
- Extra-large door for easy access

MAXIMUM EFFICIENCY

- 6-cylinder powerful DOOSAN DL06KB "Common Rail", Stage IIIB compliant EGR engine
- e-EPOS System (Electronic Power Optimising System) and hydraulic power boost function for optimised combustion and minimised emissions
- Efficient conversion of engine output into hydraulic performance for better fuel efficiency and lower costs
- Large pump capacity (2 X 170 l/min) to boost hydraulic performance and attachment control
- Electronic fan clutch reduces fuel consumption and noise level while improving cooling performance

EASY MAINTENANCE

- Easy access to all maintenance components
- Maintenance data available directly from control panel
- Centralised filters
- Fuel pre-filter with water separator
- PC access for maintenance and repairs
- Self-diagnosis function
- Reliable Doosan parts

SOLID STRENGTH

- Reinforced undercarriage and smooth transmission ensure a comfortable ride and better access to rough terrain
- Large reinforced covers completely protect the dozer and stabilizer cylinders

DX160W-3

Improved productivity and fuel efficiency

■ Expect the best return on your investment

The DX160W-3 takes even the heaviest tasks in its stride with efficient, dependable performance that saves you time and money. Increased digging power, lifting capacities and speed combine to deliver performance you can rely on day after day. Improved fuel efficiency means you can keep costs down and reduce the environmental impact.



5 ASSETS TO YOUR BENEFIT!

- Power: Doosan 6-cylinder engine 102 kW (137 HP) at 2000 rpm
- Excavation: record digging forces: bucket up to 11.7 t & arm up to 8.1 t
- Productivity: highest-in-class front lifting capacities at 6 m reach & 3 m height: 5.15 t (1-piece boom) & 4.94 t (2-piece boom)
- Excellent travel performance: 3.5 / 10 / 32 / 37 km/h
- Size: ideal dimensions and working range

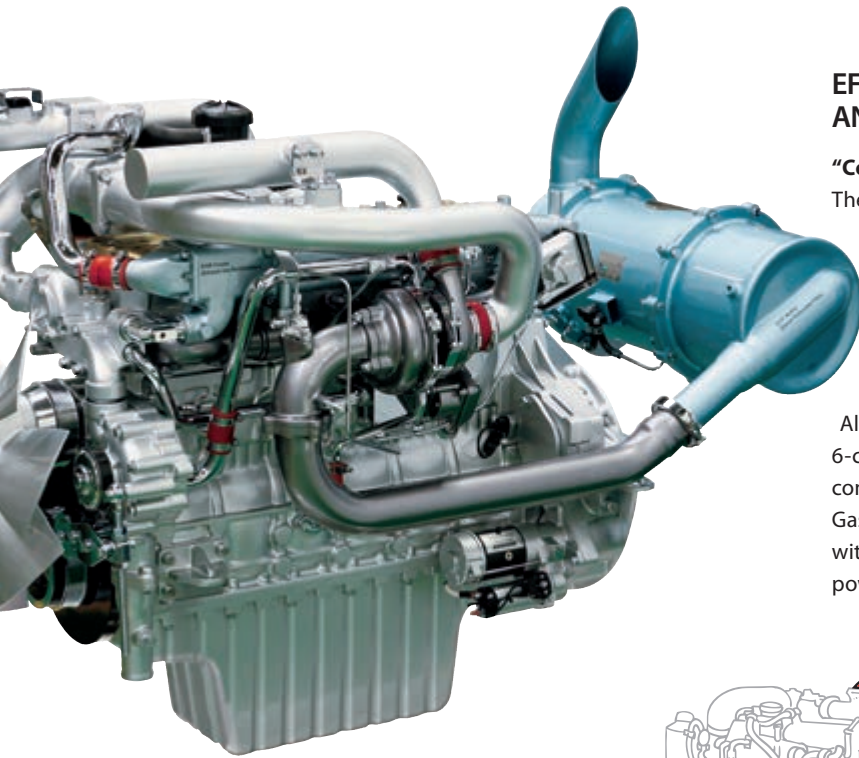

EFFICIENT MANAGEMENT OF FUEL AND HYDRAULICS

“Common Rail” Doosan DL06KB engine

The heart of the DX160W-3 is the “Common Rail” DOOSAN DL06KB engine, carefully designed with common rail injection and 4 valves per cylinder. The engine delivers 137 HP (102 kW / 137 PS) at only 2000 rpm. Powerful torque allows efficient use of the hydraulic system and faster working cycles.

Doosan Stage IIIB (Tier 4i) EGR technology with DPF

Already known for its outstanding reliability, the DOOSAN DL06KB 6-cylinder engine has been optimised for the DX160W-3 and is now compliant with the Stage IIIB European regulations using EGR (Exhaust Gas Recirculation) and DPF (Diesel Particulate Filter). In combination with the e-EPOS electronic control system, it offers the ultimate in power delivery and fuel economy.

ADVANCED TECHNOLOGY FOR OPTIMUM POWER MANAGEMENT

e-EPOS system (Electronic Power Optimising System)

If the engine is the heart of the excavator, the e-EPOS is its brain. It provides a perfectly synchronised communication link between the engine’s ECU (Electronic Control Unit) and the hydraulic system. A CAN (Controller Area Network) system enables a constant flow of information between the engine and hydraulic system, ensuring power is delivered exactly as needed.

Simple and efficient

- Choice between 4 power modes and 4 working modes guarantees optimum performance in all conditions
- Proportional auxiliary control for attachments
- Regulation and precise control of the flow rate required by the work group
- Self-diagnosis function allows technical problems to be resolved quickly and efficiently
- Operational memory provides a graphic display of the machine status
- Maintenance and oil change intervals can be displayed

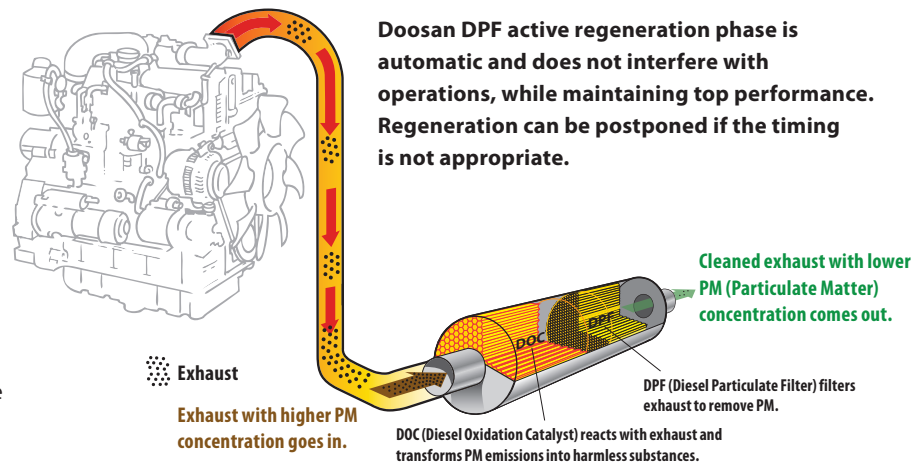

Fuel efficiency

- Auto-idle function enables fuel saving (lowered from 1000 to 800 rpm)
- New electronic fan clutch optimizes cooling for more fuel savings
- Eco gauge: monitors fuel consumption to maintain economic operation
- Improved Main Control Valve (MCV) performance reduces energy loss
- Additional sensor allows a more efficient selection of flow/pressure/ rpm according to load requirements



Quick and efficient

The main hydraulic pumps have an increased capacity of 2 X 170 l/min, reducing cycle times for heightened productivity. A high capacity gear pump improves pilot line efficiency.

Smooth and fast

The swing drive minimises shocks during rotation while making increased torque available to ensure rapid cycles.

Electronic viscous fan clutch

For optimum cooling, fan speed is controlled electrically by a fan clutch, resulting in lower fan noise and better fuel efficiency.

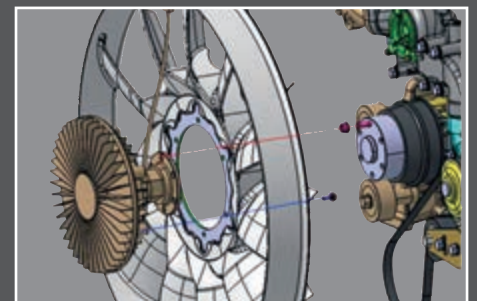

The ideal workspace – designed around you

The DX160W-3 is designed to provide you with the best possible working conditions. The sophisticated pressurised ROPS cab is ISO-certified for your safety. Its spacious interior offers a fully adjustable, heated air suspension seat. Comfortably seated, you have easy access to several storage compartments and a clear all-round view of the worksite. Noise and vibration levels have been reduced while air conditioning and automatic climate control allow you to keep working for hours on end without feeling tired.



Heated air suspension seat (standard)

As well as being adjustable and offering lumbar support, the seat has an air suspension system to reduce vibration. It also features a button to activate the seat heating system. A storage box has been placed under the seat for extra convenience.



Storage space

Plenty of storage space means you can keep all your personal belongings within reach. The new cab contains 7 storage compartments including one hot/cool box (linked to the HVAC system).

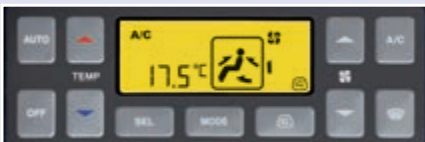

Air conditioning with climate control

The electronically controlled air conditioning system features 5 different operating modes allowing the operator to adjust the airflow to suit conditions. A recirculated air function is also available.



MP3/USB radio and USB port

A USB port (standard) allows connection of an MP3 player (MP3/USB radio with CD player optional).

When doing lifting work, be sure to observe local regulations. Never use a lifting device not permanently marked with a Rated Lifting Load (RLL).



1

ERGONOMIC OPERATOR ENVIRONMENT

Feel the comfort of a seat that fits you perfectly:

Using a dual positioning cursor, you can slide the seat back from the joysticks for the best working position. You can also slide the entire seat assembly to adjust the reach to the control pedals to your leg length.

- 1 Large sun roof and sun visor
- 2 Robust ergonomic pedals
- 3 Flat, spacious, easy-to-clean floor
- 4 Upper front window is strut-assisted for easy, reliable adjustment and integrates a sun shade
- 5 Joysticks and switches are integrated in adjustable control consoles
- 6 Separate seat height adjustment lever and cushion tilting function
- 7 Storage compartment for sunglasses
- 8 Hot/cool box
- 9 Photo sensor detects radiant energy of the sun and adjusts temperature automatically
- 10 Adjustable steering column

7

8

5

6

3

2

10

9

4



CabSus mount

The cab features a new suspension system (CabSus mount) that combines high vibration dampening with outstanding protection against impact. The system absorbs shocks and vibrations much more effectively than a conventional viscous suspension system.

Precision control for higher output

Doosan's unique new jog shuttle switch gives you easy, precise control over all machine functions. Proportional auxiliary flow means that the excavator's huge power is matched by smooth, confident manoeuvres. Using highly sensitive joysticks and clear controls positioned for convenient access, you are able to work safely and confidently with minimum effort. Even the switches have been ergonomically placed on the right and positioned according to the frequency with which they are used. The highest standards of efficiency are just a finger's reach away.



Jog shuttle control switch

- Power mode and Work mode
- Auto-idle / Buzzer Stop
- Adjustment of rpm, hydraulic flow and pressure for attachments
- 10 different attachment presets
- Rear view camera
- Multimedia: - video: AVI (DivX®), MP4, WMV
- audio: MP3
- Menu change or selection

Colour LCD monitor panel

The upgraded 7" TFT LCD panel features a day and night display and has been relocated within the operator's line of sight. The monitor is user-friendly and gives full access to machine settings and maintenance data. Any abnormality is clearly displayed on the screen, allowing you to work safely and confidently with an accurate overview of all conditions. All functions are fully controllable, directly via the screen or using the jog shuttle switch.



4 Work modes to suit your application

- 1-way mode and 2-way mode
- Digging mode and lifting mode

4 Power modes for maximum efficiency

- Power plus mode
- Power mode
- Standard mode
- Economy mode

Gauges

- Engine coolant and hydraulic oil temperatures
- Fuel level
- Eco symbol: changes colour when operating conditions change (idle, normal or loading)
- Eco gauge: shows the average fuel efficiency for 1 minute of operation
- Speed display
- Warning symbols



4 Work modes



4 Power modes



Auto-idle

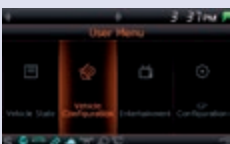

User menu

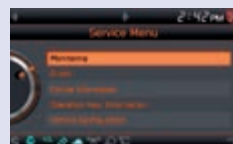

Service menu



Attachment presets



Filter/oil information



Anti-theft protection

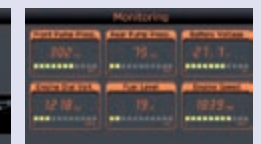

Monitoring

Your safety – our biggest concern

- A rear view camera gives you a clear view of what's happening behind the machine. A side view camera is also available as an option for jobs requiring extra safety measures
- Cab and boom lights are fitted as standard, greatly enhancing safety on night-time jobs
- Large side mirrors improve all-round visibility (ISO compliant)

Other standard safety features include: cruise control, 3 front axle oscillation lock modes (On/Off/Auto), automatic overheating prevention, low oil pressure sensor, engine emergency cut-off switch, auxiliary mode switch, overload warning device, cab swing lock pin, etc.





When doing lifting work, be sure to observe local regulations. Never use a lifting device not permanently marked with a Rated Lifting Load (RL).

Simple operation

- "Short stroke" joysticks enable easy, precise control of all operations
- A thumb wheel switch and buttons on the joysticks allow proportional control of attachments such as grabs, crushers and grapples as well as control of rotating attachments
- Joystick integrated Forward - Neutral - Reverse (FNR) switch

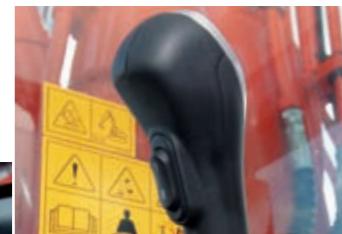

Dynamic power management

- 2-speed POWER-SHIFT transmission, with economy mode and creep speed.
- Activation of the power boost control system increases digging power by 10%
- A one-touch deceleration button immediately reduces engine speed to low or idle
- Auto-idling starts after 4 seconds at low rpm. This decreases fuel consumption and reduces noise levels in the cab
- Jog shuttle dial for engine rpm

Floating boom function

- The intelligent floating boom mode allows the boom to move up and down freely when external force is applied.
- The breaker mode restricts the boom to downward movement only. This means that the breaker can be operated using only the weight of the work group on the front, without additional force. The breaker remains in constant contact with the object. The result is reduced shock and vibration and longer breaker service life.
- During truck loading, the lowering of the boom can be controlled without hydraulic pump flow discharge. This increases productivity and fuel efficiency.

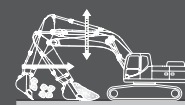

Quality that never lets you down

■ Designed for long-term heavy duty use

In your profession you need equipment you can depend on. At Doosan, we use highly specialised design and analysis tools to make sure our machines are as robust and durable as can be. Our materials and structures undergo stringent testing for strength and resilience in the most extreme conditions.

UNDERCARRIAGE DESIGN

A rigid, welded frame provides excellent durability. Efficient routing of hydraulic lines, transmission and rear differential protection and heavy duty axles make the undercarriage perfect for wheeled excavator applications. An oscillating axle lock is available.

New drive line concept

The new travel motor and transmission control in the drive line provide comfortable travel due to increased smoothness, improved hydraulic retarding and improved gear shifting.

Advanced disc brake system

The new improved system allows a more efficient braking of the machine. This eliminates the rocking effect associated with working on wheels. The new axles are designed for low maintenance, and the oil change intervals have been increased to 2000 hours, further reducing owning and operating costs.

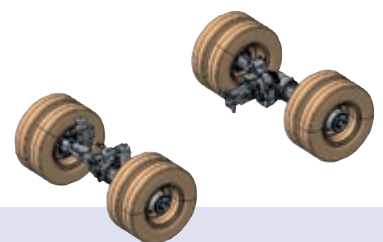
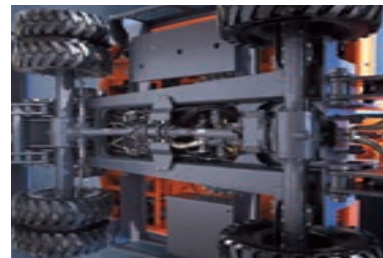

Strengthened boom

Finite Element Analysis (FEA) has been used to calculate the best load distribution throughout the boom structure. Combined with increased material thickness, this means that element fatigue is limited and both reliability and component life are increased.

Arm assembly

Cast elements and reinforcements have been added to give the arm assembly greater strength and a longer lifetime. The arm end boss, arm link boss and side plates have been combined for increased durability.

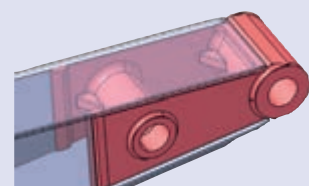

Heavy duty axles

The front axle offers wide oscillating and steering angles. The transmission is mounted directly on the rear axle for protection and optimum ground clearance.



D-type frame

The D-type frame and chassis frame add strength and minimise distortion due to shocks. The chassis frame, stabilizer assembly and dozer blade have been designed using interpretative techniques and tested with 3 dimension CAD tools to ensure improved durability and reliability.

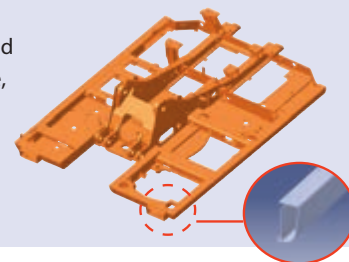

Protected hydraulics

The hydraulic line routing is straight and simple for a neat, compact design that enhances its durability. The gap between the pipe flange and rubber cushion has been reduced to minimise slack.



Cast counterweight

A cast counterweight minimises deformation resulting from external impact. Operating stability has been increased by use of a low center of gravity design.



LED (luminescent diode) type stop lamps

The use of LED type stop lamps and blinkers ensures considerably improved average service life compared to the existing standard filament bulbs. Furthermore, the faster lighting speed helps to prevent accidents.



The undercarriage provides excellent stability and durability. It is designed to excel in tough working environments.

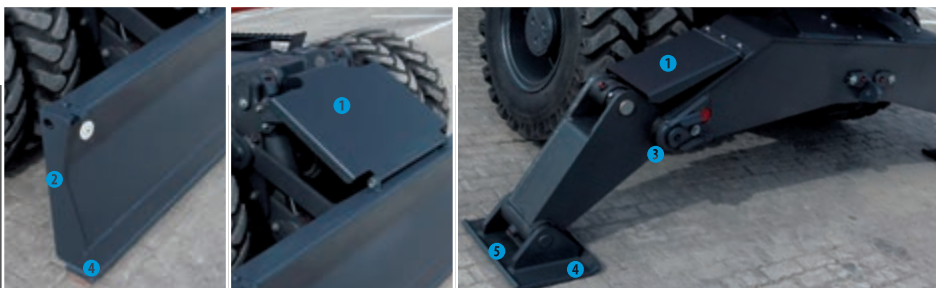

Exclusive parallel dozer and independent stabilizer design:

- ❶ Large reinforced covers protect the dozer and stabilizer cylinders from falling stones or objects while the machine is in operation.
- ❷ The shape of the dozer blade is designed to facilitate pulling and mixing of materials.
- ❸ The stabilizers are kept well within the machine envelope and the position of the pins is kept high to avoid bumping while moving over the ground.
- ❹ The parts of the stabilizers and dozer blade in contact with the ground have been carefully designed to prevent damage to the surface.
- ❺ The stabilizer pads are made as wide as possible to reduce ground pressure.



Extra strong sintered bushings

A highly lubricated metal is used for the boom pivot to increase the component lifetime and extend the greasing intervals. The bucket pivot has Enhanced Macrosurface bushings which feature a special surface pattern and self-lubricating coating to reduce friction and provide more efficient evacuation of debris.

More value – less maintenance

Short maintenance operations at long intervals mean you can depend on your equipment being available on site when it's needed. The DX160W-3 is designed for simple routine maintenance, while skilled Doosan technicians are available to provide extra support when you need it. You can choose the package you need from a broad range of service agreements to get the most out of your machine. Uptime, productivity and residual value are all maximised, making the DX160W-3 an economical and rewarding choice.



Maintenance access made simple

- Large handrails and anti-slip steps and plates provide safer, easier access to the engine compartment
- The air conditioning filter is lockable and placed on the side of the cab for easy access
- A battery cut-off switch makes it easy to disconnect the battery during long-term storage
- The hour meter display can be easily checked from ground level
- Cock valves are fitted on the pre-filter piping line and fuel tank drain piping to make servicing easier and prevent pollution from leakage



Access to components

- Engine parts can be easily reached via the top and side panels
- Access to the various radiators and filters is very easy, making routine maintenance easier

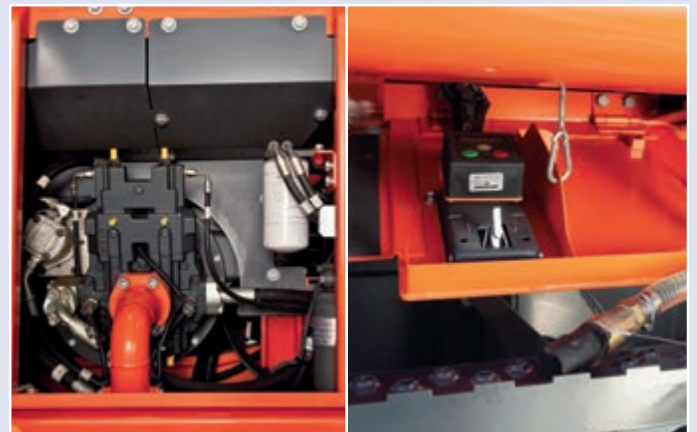

- New, convenient location of the auto shut-off fuel filling pump

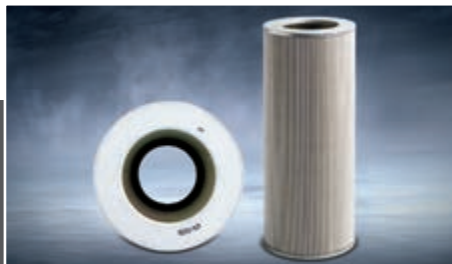

Protective oil return filter

The protection of the hydraulic system is made more effective by the use of glass fibre technology in the main oil return filter. With more than 99.5% of foreign particles filtered out, the oil change interval is extended.



Engine oil filter

The engine oil filter offers a high level of filtration, allowing a long interval between changes. It is easy to access and is positioned to avoid contaminating the surrounding environment.



Fuel pre-filter with water separator sensor

High efficiency fuel filtration is attained by the use of multiple filters. These include a fuel pre-filter fitted with a water separator that removes moisture, dirt and debris from the fuel. A warning sensor is added to each fuel filter to indicate when water draining is required.

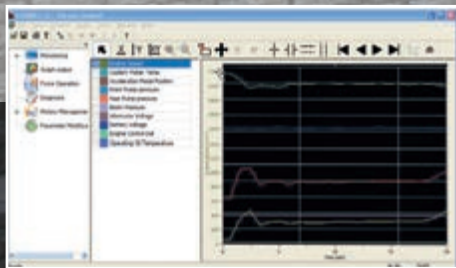

PC monitoring

A PC monitoring function enables connection to the e-EPOS system. Various parameters can be checked during maintenance, including pump pressures and engine speed. This information can be saved and printed for analysis.



Convenient fuse box

The fuse box is located in the storage compartment behind the seat, providing a clean environment and convenient access.

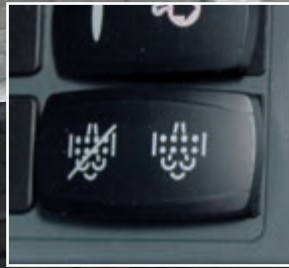

DPF regeneration switch

Active regeneration is automatic and doesn't interfere with operation. When the level of soot is too high, a warning symbol alerts the operator that he can activate regeneration at any time.



Centralised greasing points

To make maintenance easier, the greasing points have been centralised.

Technical specifications

* Engine

• Model

Doosan DL06KB
4-Cycle Water-Cooled, Variable Geometry Turbocharged,
Common Rail Direct Injection, Exhaust Gas Recirculation

• No. of cylinders

6

• Rated power at 2000 rpm

101 kW (137 PS) (DIN 6271)
101 kW (135 HP) (SAE J1349)
102 kW (137 HP) (SAE J1995)

• Max. torque at 1400 rpm

60 kgf/m (588 Nm)

• Idle (low - high)

800 [± 25] - 2080 [±50] rpm

• Piston displacement

5890 cm³

• Bore x stroke

Ø 100 x 125 mm

• Starter

24 V / 6.0 kW

• Batteries / Alternator

2 x 12 V, 150 Ah / 24 V, 80 A

• Air filter

Double element and pre-filtered Turbo with automatic dust evacuation.
Filtration area 7.6 m² (outer), 1.4 m² (inner)
Size (diameter x length) 279.4 mm x 489.5 mm

* Weights

Boom (mm)	Arm (mm)	C/W (t)	Chassis - Front	Chassis - Rear	Weight Total	Front	Rear
1-piece boom (4600)	2100	2.2	Dozer	Stab	15846	6446	9399
1-piece boom (4600)	2500	2.5	Dozer	Stab	16236	6518	9718
		2.5	Stab	Dozer	16236	6999	9237
2-piece boom (2000 + 3350)	2100	2.5	Dozer	Stab	16702	5717	10984
2-piece boom (2000 + 3350)	2500	2.5	Cradle	Dozer	15677	5088	10589
		2.5	Dozer	Stab	16762	5956	10806
		2.5	Stab	Dozer	16762	6437	10324

* Undercarriage

Very robust construction throughout. All welded structures designed to limit stresses. High-quality, durable materials. Lateral chassis welded and rigidly attached to undercarriage. Heat-treated connecting pins. 10.00-20-14PR (OTR) double tyres with tyre spacer or single tyres 18-19.5-16PR (optional). Heavy-duty front axle with automatic or operator-controlled (on/off) front axle oscillation lock.

• Front axle oscillation

+/- 7.94° with automatic ram lock

* Brakes

Dual multi-disc circuit with sintered metal discs for extended service life. Braking system activated by a pump and accumulator circuits. Spring-applied, hydraulically released parking brake mounted on the transmission shaft.

* Hydraulic system

The brain of the excavator is the e-EPOS (Electronic Power Optimizing System). It allows operation of the hydraulic system to be optimised for all working conditions and minimises fuel consumption.

The e-EPOS is connected to the engine's electronic control unit (ECU) via a data transfer link to harmonise the operation of the engine and the hydraulic system.

- The hydraulic system allows independent or combined operations
- Two travel speeds offer either increased torque or high speed
- Cross-sensing pump system for fuel savings
- Auto deceleration system
- Four operating modes, four power modes
- Button control of flow in auxiliary hydraulic circuits
- Computer-aided pump flow control

• Maximum system pressure

Implement (boom/arm/bucket): 380 kg/cm² [±5]
Work/travel: 350 kg/cm² [±5] / 370 kg/cm² [±5]
Swing: 275 kg/cm² [±5]
Pilot: 40 kgf/cm²

* Pumps

Pump	Type	Displacement	Max. flow @ 2000 rpm	Relief valve pressure
Main (2)	Tandem, Axial piston	85.0 cm ³ /rev.	2 X 170 l/min	-
Pilot	Gear	10.7 cm ³ /rev.	24.1 l/min	40 kgf/cm ²
Steering	Gear	19.1 cm ³ /rev.	35.5 l/min	175 kgf/cm ²
Brake	Gear	7.3 cm ³ /rev.	13.6 l/min	160 kgf/cm ²

* Hydraulic cylinders

Piston rods and cylinder bodies of high-strength steel. Shock-absorbing mechanism fitted in all cylinders for shock-free operation and extended piston life.

Cylinders	Quantity	Bore x rod diameter x stroke (mm)
One-piece boom	2	110 x 75 x 1035
Two-piece boom upper	2	110 x 75 x 975
Two-piece boom lower	1	140 x 85 x 720
Arm - 4.6 boom	1	115 x 80 x 1068
Bucket	1	95 x 65 x 900
Blade	2	100 x 60 x 204
Stabilizer	2	110 x 70 x 438

* Swing mechanism

- High-torque, axial piston motor with planetary reduction gear in oil bath
- Swing circle: single-row, shear type ball bearing with induction-hardened internal gear
- Internal gear and pinion immersed in lubricant
- Increased swing torque reduces swing time
- The swing brake for parking is activated by spring and released hydraulically
- Max. swing speed (Eff.=0.98): 0 to 11.4 rpm
- Max. swing torque (Eff.=0.78): 3744 kgf/m

* Drive

The wheels are driven by an axial piston engine via a two-speed powershift transmission.
In addition to the two-speed powershift transmission, there is also an economy mode and a switch for the creep speed.
A button makes it possible to pass from high to low in work mode.

• Travel speed

Two travel speed ranges offer a choice between increased torque or high speed.

High	/ Eco	/ Low	/ Creep
37	/ 32	/ 10	/ 3.5 km/h

• Maximum traction

8.3 t

• Maximum gradeability

35° / 70%

* Fluid capacities

• Fuel tank

280 l

• Cooling system (radiator capacity)

20 l

• Hydraulic oil tank

102 l

• Engine oil

22 l

• Swing drive

2 l

• Front axle hub

2 x 2.5 l

• Rear axle hub

2 x 2.4 l

• Front axle case

9 l

• Rear axle case

11.2 l

• Transmission

2.5 l

* Environment

Noise levels comply with environmental regulations (dynamic values).

• Noise level LwA

Guaranteed / measured: 102 dB(A) / 100 dB(A) (2000/14/EC)

• Operator LpA

69 dB(A) (ISO 6396)

* Buckets

Bucket Type	Capacity (m ³) SAE	C/W			2.5 t			
		Width (mm)		Weight (kg)	Boom: 4.6 m		2-piece boom	
		With side cutters	Without side cutters		Arm: 2.1 m	Arm: 2.5 m	Arm: 2.1 m	Arm: 2.5 m
Normal	0.59	1081	997	420	A	A	A	A
	0.24	534	468	292	A	A	A	A
	0.39	820	736	350	A	A	A	A
	0.45	911	824	389	A	A	A	A
	0.51	991	907	398	A	A	A	A
	0.64	1167	1083	443	A	A	A	A
	0.76	1220	1120	437	A	A	B	B
HD	0.42	827	762	462	A	A	A	A
	0.49	913	848	497	A	A	A	A
	0.54	981	916	517	A	A	A	A

Based on ISO 10567 and SAE J296, arm length without quick-coupler. For reference only.

A: Suitable for materials with a density less than or equal to 2100 kg/m³ / B: Suitable for materials with a density less than or equal to 1800 kg/m³

* Digging forces (ISO)

		1-piece boom: 4600 mm Arm: 2100 mm Bucket: 0.51 m ³	1-piece boom: 4600 mm Arm: 2500 mm Bucket: 0.51 m ³	2-piece std boom: 4988 mm Arm: 2100 mm Bucket: 0.51 m ³	2-piece std boom: 4988 mm Arm: 2500 mm Bucket: 0.51 m ³
BUCKET (Normal/Press. Up)	t	10.00 / 10.57	10.00 / 10.57	11.08 / 11.72	11.08 / 11.72
	kN	98.0 / 103.6	98.0 / 103.6	108.6 / 114.9	108.6 / 114.9
ARM (Normal/Press. Up)	t	7.68 / 8.12	6.54 / 6.90	7.68 / 8.12	6.54 / 6.90
	kN	75.3 / 79.6	64.1 / 67.7	75.3 / 79.6	64.1 / 67.7

Dimensions

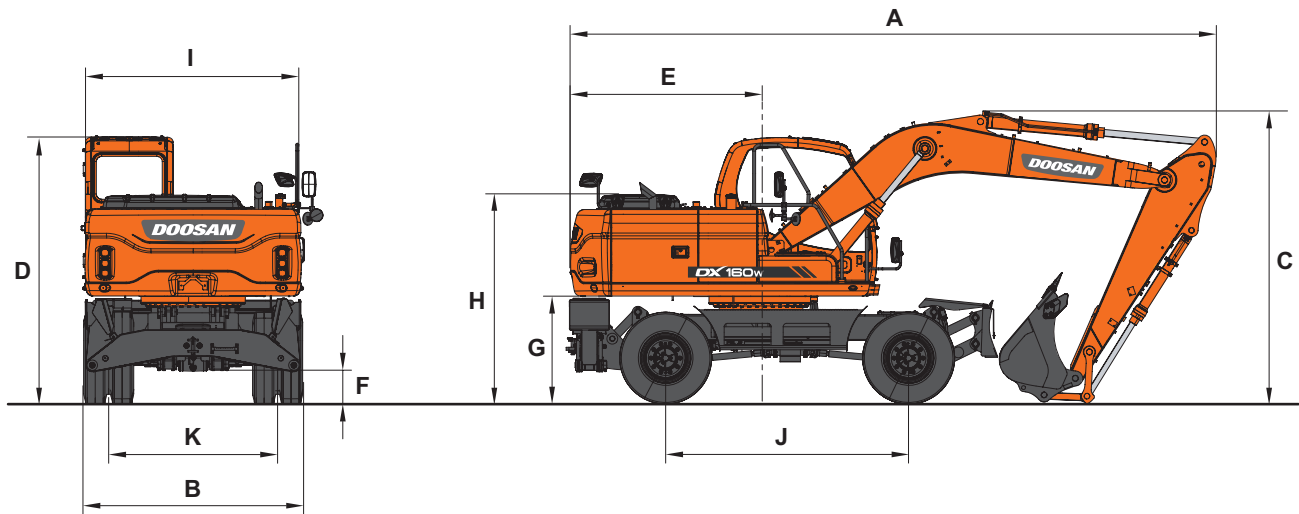

* Dimensions one-piece and two-piece boom

Boom length - mm		4600 (one-piece boom)		4988 (two-piece boom)	
Arm length - mm		2100	2500	2100	2500
A	Shipping length - mm	7470	7185	8005	7885
B	Shipping width - mm	2500	2500	2500	2500
C	Shipping height (boom) - mm	3430	3950	2725	3070
D	Height over cab - mm	3065	3065	3065	3065
E	Counterweight swing clearance - mm	2200	2200	2200	2200
F	Ground clearance - mm	350	350	350	350
G	Counterweight clearance - mm	1215	1215	1215	1215
H	Engine cover height - mm	2385	2385	2385	2385
I	Upper housing width - mm	2500	2500	2500	2500
J	Wheel base - mm	2800	2800	2800	2800
K	Tread width - mm	1944	1944	1944	1944

* Component weights

Item		Remarks
Upperstructure without front - kg	7175	Including counterweight
Undercarriage - kg	4832	Including S/B, F-CR & R-DOZ
Front assembly - kg	2206	
Counterweight - kg	2500	
Boom 4600 mm - kg	778	
Arm 2100 mm - kg	375	
Bucket - kg	408	0.59 m ³
Boom cylinder (each) - kg	106	
Arm cylinder - kg	151	
Bucket cylinder - kg	87	
Dozer blade - kg	672	
Dozer blade cylinder (each) - kg	42	
Stabilizer - kg	960	
Stabilizer cylinder (each) - kg	74	
Arm 2500 mm - kg	418	
Two-piece boom - upper / lower - kg	592 / 384	
Two-piece boom cylinder - kg	150	

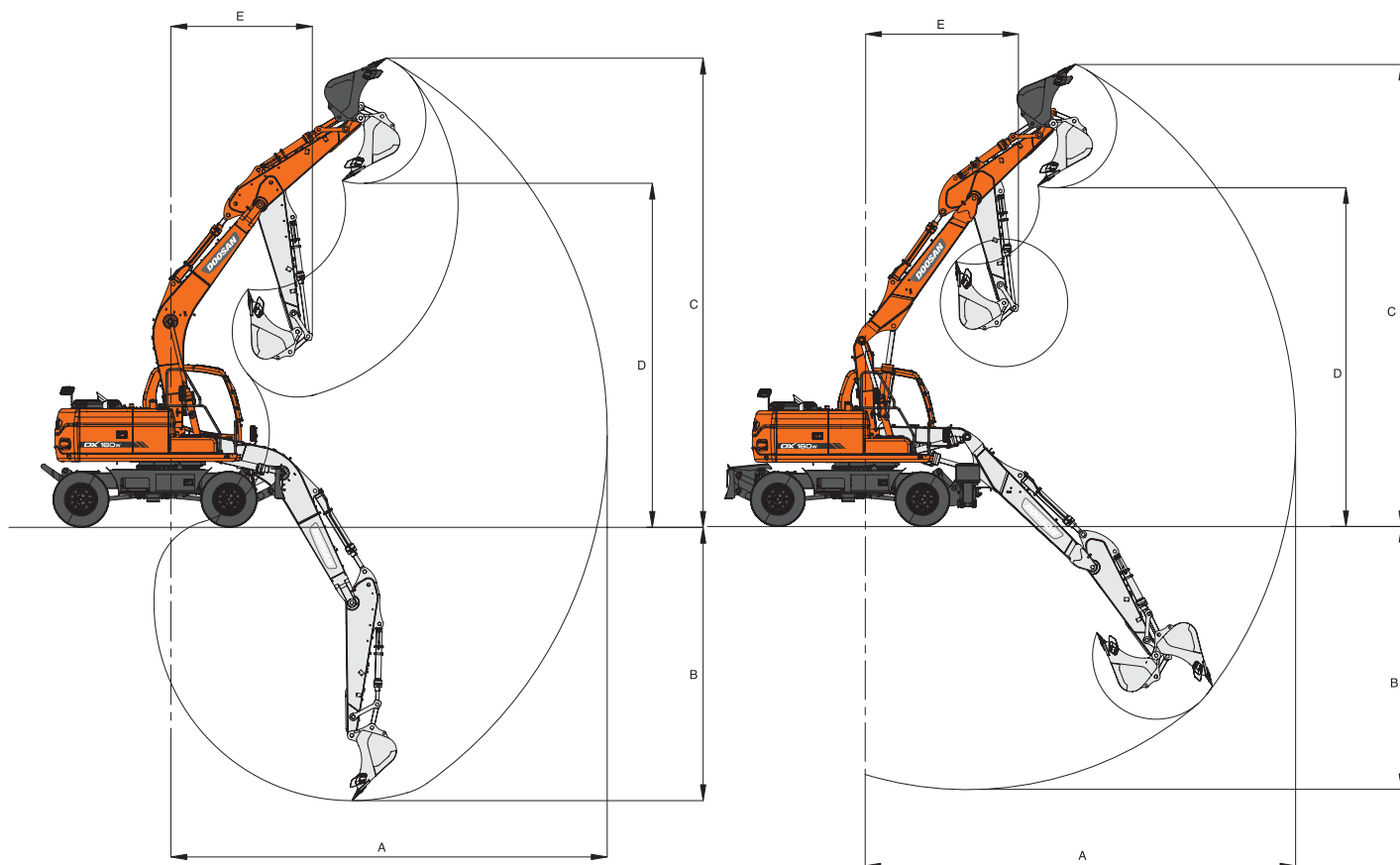

* Working range one-piece and two-piece boom

Boom length - mm		4600 (one-piece boom)		4988 (two-piece boom)	
Arm length - mm		2100	2500	2100	2500
A	Max. digging reach - mm	7765	8235	8210	8670
B	Max. digging depth - mm	4620	5020	5025	5455
C	Max. digging height - mm	8340	8850	9060	9565
D	Max. dump height - mm	6060	6510	6715	7175
E	Min. digging reach - mm	2500	2665	2650	2850



Lifting capacities

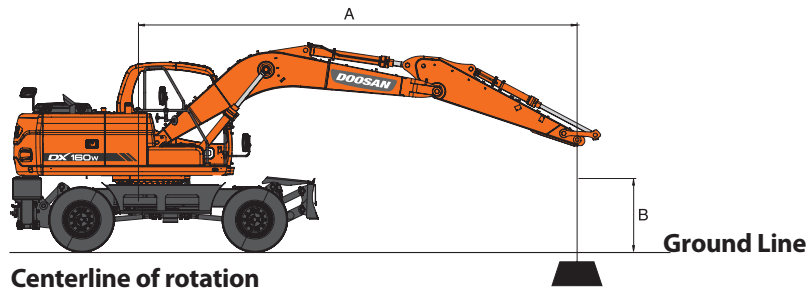

Standard configuration – One-piece boom

Boom: 4600 mm • Arm: 2100 mm • W/O Bucket • Counterweight: 2500 kg

Units: 1000 kg

A (m) B (m)	Chassis Frame Attachment	1.5		3.0		4.5		6.0		Max. lift		A (m)
6.0	R- Dozer Up					4.36*	4.06			3.11*	3.11*	4.95
	F-Dozer + R-Stabilizer Down					4.36*	4.36*			3.11*	3.11*	
4.5	R-Rear Dozer Only Up					5.72*	3.98			2.97*	2.60	5.93
	F-Dozer + R-Stabilizer Down					5.72*	5.72*			2.97*	2.97*	
3.0	R-Rear Dozer Only Up			9.81*	6.82	6.61*	3.79	4.86	2.49	3.05*	2.25	6.43
	F-Dozer + R-Stabilizer Down			9.81*	9.81*	6.61*	6.27	5.15*	4.04	3.05*	3.05*	
1.5	R-Rear Dozer Only Up					7.45*	3.58	4.77	2.41	3.34*	2.14	6.54
	F-Dozer + R-Stabilizer Down					7.45*	6.04	5.62*	3.96	3.34*	3.34*	
0 (Ground)	R-Rear Dozer Only Up			8.69*	6.15	7.35	3.46	4.71	2.36	3.96*	2.21	6.3
	F-Dozer + R-Stabilizer Down			8.69*	8.69*	7.63*	5.90	5.55*	3.90	3.96*	3.64	
-1.5	R-Rear Dozer Only Up	7.60*	7.60*	9.76*	6.19	6.90*	3.45			5.10*	2.55	5.66
	F-Dozer + R-Stabilizer Down	7.60*	7.60*	9.76*	9.76*	6.90*	5.89			5.10*	4.23	
-3.0	R-Rear Dozer Only Up			6.80*	6.35					4.56*	3.61	4.45
	F-Dozer + R-Stabilizer Down			6.80*	6.80*					4.56*	4.56*	

Option 1 – One-piece boom

Boom: 4600 mm • Arm: 2500 mm • W/O Bucket • Counterweight: 2500 kg

Units: 1000 kg

A (m) B (m)	Chassis Frame Attachment	1.5		3.0		4.5		6.0		Max. lift		A (m)
7.5	R- Dozer Up									2.76*	2.76*	3.93
	F-Dozer + R-Stabilizer Down									2.76*	2.76*	
6.0	R-Rear Dozer Only Up					3.97*	3.97*			2.26*	2.26*	5.55
	F-Dozer + R-Stabilizer Down					3.97*	3.97*			2.26*	2.26*	
4.5	R-Rear Dozer Only Up					4.66*	4.03	3.53*	2.58	2.13*	2.13*	6.44
	F-Dozer + R-Stabilizer Down					4.66*	4.66*	3.53*	3.53*	2.13*	2.13*	
3.0	R-Rear Dozer Only Up			8.93*	6.98	6.26*	3.82	4.83*	2.51	2.14*	2.02	6.90
	F-Dozer + R-Stabilizer Down			8.93*	8.93*	6.26*	6.26*	4.83*	4.06	2.14*	2.14*	
1.5	R-Rear Dozer Only Up					7.23*	3.59	4.77	2.41	2.28*	1.93	7.01
	F-Dozer + R-Stabilizer Down					7.23*	6.06	5.50*	3.96	2.28*	2.28*	
0 (Ground)	R-Rear Dozer Only Up			8.24*	6.12	7.34	3.45	4.69	2.34	2.58*	1.98	6.79
	F-Dozer + R-Stabilizer Down			8.24*	8.24*	7.62*	5.89	5.60*	3.88	2.58*	2.58*	
-1.5	R-Rear Dozer Only Up	6.30*	6.30*	10.39*	6.11	7.16*	3.40	4.68	2.33	3.21*	2.24	6.20
	F-Dozer + R-Stabilizer Down	6.30*	6.30*	10.39*	10.39*	7.16*	5.84	5.01*	3.87	3.21*	3.21*	
-3.0	R-Rear Dozer Only Up			7.85*	6.24	5.41*	3.47			4.29*	2.95	5.11
	F-Dozer + R-Stabilizer Down			7.85*	7.85*	5.41*	5.41*			4.29*	4.29*	



- Lifting capacities are in compliance with ISO 10567:2007(E).
- The load point is at the end of the arm.
- * = The nominal loads are based on hydraulic capacity.
- The nominal loads shown do not exceed 75% of tipping loads or 87% of hydraulic lifting capacity.
- Weight of all lifting accessories must be deducted from or added to the above lifting capacities.
- The configurations indicated do not necessarily reflect the standard equipment of the machine.

: Rating over front
 : Rating over side or 360°

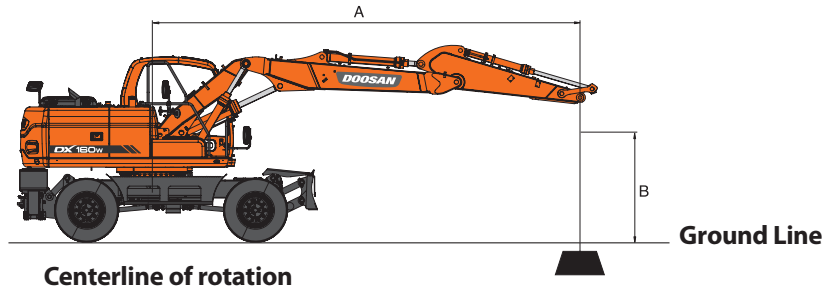

Option 2 – Two-piece boom

Boom: 4988 mm • Arm: 2500 mm • W/O Bucket • Counterweight: 2500 kg

Units: 1000 kg

A (m) B (m)	Chassis Frame Attachment	1.5		3.0		4.5		6.0		Max. lift		A (m)
		☺	☹	☺	☹	☺	☹	☺	☹	☺	☹	
7.5	R- Dozer Up					3.33*	3.33*			2.82*	2.82*	4.69
	R- Dozer Down					3.33*	3.33*			2.82*	2.82*	
	F-Dozer + R-Stabilizer Down					3.33*	3.33*			2.82*	2.82*	
6.0	4-Stabilizer Down					3.33*	3.33*			2.82*	2.82*	6.10
	R-Rear Dozer Only Up					4.13*	4.13*	2.80*	2.59	2.40*	2.40*	
	R-Rear Dozer Only Down					4.13*	4.13*	2.80*	2.80*	2.40*	2.40*	
	F-Dozer + R-Stabilizer Down					4.13*	4.13*	2.80*	2.80*	2.40*	2.40*	
4.5	4-Stabilizer Down					4.13*	4.13*	2.80*	2.80*	2.40*	2.40*	6.92
	R-Rear Dozer Only Up					4.78*	4.02	4.27*	2.57	2.26*	2.01	
	R-Rear Dozer Only Down					4.78*	4.46	4.27*	2.85	2.26*	2.24	
	F-Dozer + R-Stabilizer Down					4.78*	4.78*	4.27*	4.16	2.26*	2.26*	
3.0	4-Stabilizer Down					4.78*	4.78*	4.27*	4.27*	2.26*	2.26*	7.35
	R-Rear Dozer Only Up					5.83*	3.75	4.72*	2.46	2.26*	1.79	
	R-Rear Dozer Only Down					5.83*	4.19	4.72*	2.74	2.26*	1.99	
	F-Dozer + R-Stabilizer Down					5.83*	5.83*	4.72*	4.05	2.26*	2.26*	
1.5	4-Stabilizer Down					5.83*	5.83*	4.72*	4.72*	2.26*	2.26*	7.45
	R-Rear Dozer Only Up					6.87*	3.48	4.75	2.35	2.38*	1.71	
	R-Rear Dozer Only Down					6.87*	3.91	5.18*	2.62	2.38*	1.91	
	F-Dozer + R-Stabilizer Down					6.87*	5.98	5.18*	3.92	2.38*	2.38*	
0 (Ground)	4-Stabilizer Down					6.87*	6.87*	5.18*	4.65	2.38*	2.38*	7.24
	R-Rear Dozer Only Up					7.27	3.32	4.65	2.26	2.64*	1.75	
	R-Rear Dozer Only Down					7.39*	3.74	5.44*	2.53	2.64*	1.96	
	F-Dozer + R-Stabilizer Down					7.39*	5.80	5.44*	3.82	2.64*	2.64*	
-1.5	4-Stabilizer Down					7.39*	7.02	5.44*	4.55	2.64*	2.64*	6.70
	R-Rear Dozer Only Up			8.72*	5.93	7.20*	3.28	4.63	2.24	3.15*	1.95	
	R-Rear Dozer Only Down			8.72*	6.81	7.20*	3.70	5.25*	2.51	3.15*	2.19	
	F-Dozer + R-Stabilizer Down			8.72*	8.72*	7.20*	5.75	5.25*	3.80	3.15*	3.15*	
-3.0	4-Stabilizer Down			8.72*	8.72*	7.20*	6.97	5.25*	4.52	3.15*	3.15*	5.71
	R-Rear Dozer Only Up			8.66*	6.07	6.13*	3.35			4.33*	2.47	
	R-Rear Dozer Only Down			8.66*	6.96	6.13*	3.77			4.33*	2.76	
	F-Dozer + R-Stabilizer Down			8.66*	8.66*	6.13*	5.82			4.33*	4.16	
-3.0	4-Stabilizer Down			8.66*	8.66*	6.13*	6.13*			4.33*	4.33*	5.71

Option 3 – Two-piece boom

Boom: 4988 mm • Arm: 2100 mm • W/O Bucket • Counterweight: 2500 kg

Units: 1000 kg

A (m) B (m)	Chassis Frame Attachment	1.5		3.0		4.5		6.0		Max. lift		A (m)
		☺	☹	☺	☹	☺	☹	☺	☹	☺	☹	
7.5	R- Dozer Up									3.85*	3.85*	3.89
	R- Dozer Down									3.85*	3.85*	
	F-Dozer + R-Stabilizer Down									3.85*	3.85*	
6.0	R-Rear Dozer Only Up					4.66*	4.10			3.25*	2.93	5.52
	R-Rear Dozer Only Down					4.66*	4.54			3.25*	3.24	
	F-Dozer + R-Stabilizer Down					4.66*	4.66*			3.25*	3.25*	
	4-Stabilizer Down					4.66*	4.66*			3.25*	3.25*	
4.5	R-Rear Dozer Only Up			6.57*	6.57*	5.17*	3.96	4.60*	2.54	3.11*	2.27	6.42
	R-Rear Dozer Only Down			6.57*	6.57*	5.17*	4.40	4.60*	2.82	3.11*	2.52	
	F-Dozer + R-Stabilizer Down			6.57*	6.57*	5.17*	5.17*	4.60*	4.13	3.11*	3.11*	
	4-Stabilizer Down			6.57*	6.57*	5.17*	5.17*	4.60*	4.13	3.11*	3.11*	
3.0	R-Rear Dozer Only Up					6.19*	3.71	4.87	2.45	3.17*	1.98	6.88
	R-Rear Dozer Only Down					6.19*	4.14	4.94*	2.73	3.17*	2.21	
	F-Dozer + R-Stabilizer Down					6.19*	6.19*	4.94*	4.03	3.17*	3.17*	
	4-Stabilizer Down					6.19*	6.19*	4.94*	4.03	3.17*	3.17*	
1.5	R-Rear Dozer Only Up					7.12*	3.46	4.75	2.35	3.42*	1.89	6.99
	R-Rear Dozer Only Down					7.12*	3.89	5.33*	2.62	3.42*	2.11	
	F-Dozer + R-Stabilizer Down					7.12*	5.95	5.33*	3.91	3.42*	3.14	
	4-Stabilizer Down					7.12*	5.95	5.33*	3.91	3.42*	3.14	
0 (Ground)	R-Rear Dozer Only Up					7.29	3.34	4.67	2.28	3.93*	1.95	6.76
	R-Rear Dozer Only Down					7.45*	3.76	5.49*	2.55	3.93*	2.18	
	F-Dozer + R-Stabilizer Down					7.45*	5.81	5.49*	3.84	3.93*	3.26	
	4-Stabilizer Down					7.45*	5.81	5.49*	3.84	3.93*	3.26	
-1.5	R-Rear Dozer Only Up			9.93*	6.02	7.05*	3.33	4.67	2.28	4.49	2.20	6.17
	R-Rear Dozer Only Down			9.93*	6.90	7.05*	3.75	5.07*	2.55	4.83*	2.47	
	F-Dozer + R-Stabilizer Down			9.93*	9.93*	7.05*	5.80	5.07*	3.84	4.83*	3.70	
	4-Stabilizer Down			9.93*	9.93*	7.05*	5.80	5.07*	3.84	4.83*	3.70	

Undercarriage

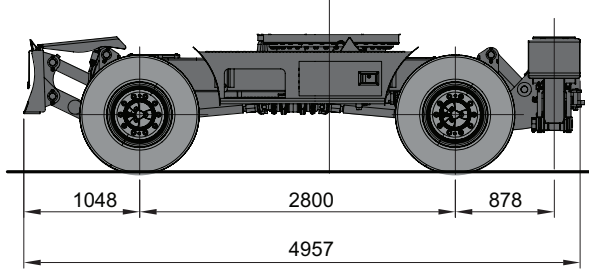
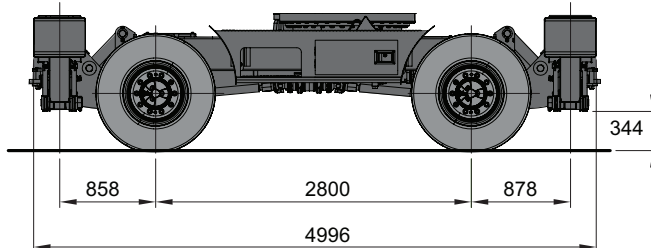
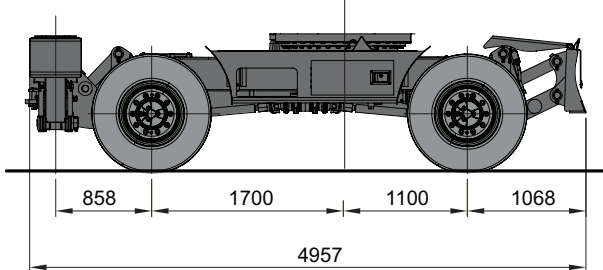
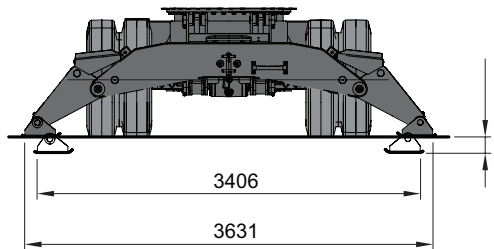
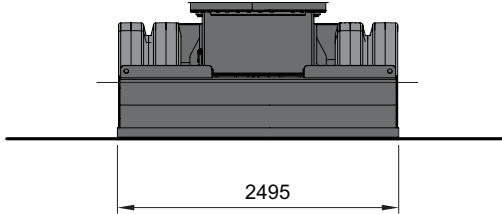
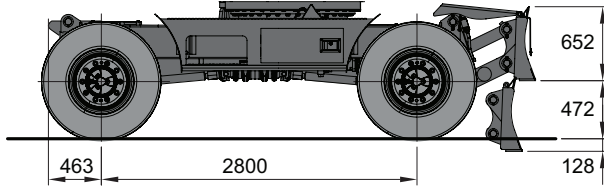
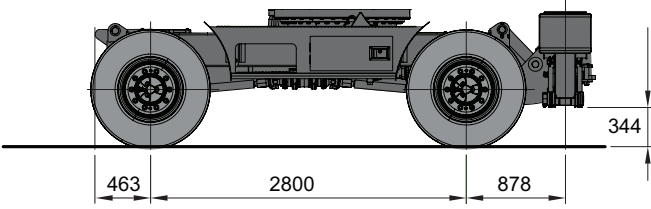

* Standard equipment

Engine
DOOSAN DL06KB turbocharged, Common Rail direct injection, EU Stage IIIB compliant Diesel engine combined with e-EPOS System
Automatic engine warm-up system
Fuel pre-filter with water separator sensor
Diesel particulate filter (DPF)
Fuel and Engine speed (RPM) control dial
Auto-idle
Hydraulic system
Boom and arm flow regeneration
Swing anti-rebound valves
Spare ports (valve)
Breaker piping
Cylinder cushioning & contamination seals
Control of auxiliary hydraulic flow and pressure from the display panel
Cab & Interior
Roll Over Protective Structure (ROPS)
Pressurised, sound-insulated and CabSus mounted cab
Heated, adjustable air suspension seat with adjustable headrest and armrest
Jog shuttle switch
Air conditioning with climate control
4 speed (high, eco, low, creep) with cruise control
One-touch power boost
Attachment management system
Pull-up type front window with sun roller blind and removable lower front window
Ceiling light
Intermittent upper windshield wiper
Multiple storage compartments (e.g. document holder under seat) and coat hook
Rain visor
Flat, spacious, easy-to-clean floor
Cigarette lighter and ashtray
Cup holder and magazine rack
Anti-theft protection (control panel password)
Hot and cool box
7" (18 cm) LCD colour monitor panel with digital speed display
Automatic rear window defroster
4 operating modes & 4 working modes
Adjustable tiltable steering column
Radio-ready and remote radio On/Off switch
12 V spare power socket
Serial communication port for laptop PC interface
Adjustable PPC wrist control levers for arm, boom, bucket and swing, with sliding proportional control for attachments, FNR switch and auxiliary hydraulic buttons
USB port
DPF regeneration switch
Sliding left front and rear windows with lock
Travel pedals and hand levers
Master key
Safety
Boom, arm, dozer blade and stabilizer cylinder safety valves
Overload warning device
Large handrails and step
Rotating beacon
Rear view camera
Punched metal anti-slip plates
Hydraulic safety lock lever
Safety glass
Hammer for emergency escape
Right and left rearview mirrors
Emergency engine stop and hydraulic pump control switches
Emergency auxiliary FNR travel selector switch
Reinforced cast steel pivot points
Mirror on counterweight
Halogen work lights (2 front frame, 4 front cab-mounted, 2 rear cab-mounted, 2 boom-mounted and 1 rear side)
Street lights with LED stop lamps + LED blinker with side reflex reflectors
Reverse travel alarm (with On/Off switch)
Parking brake and cab swing lock pin
Engine overheat and restart prevention system
Other
One-piece boom 4600 mm – arm: 2500 mm
Counterweight 2500 kg
Powershift transmission
Auto shut-off fuel filler pump
Double element air cleaner
Dry type pre-cleaner
Dust screen for radiator/oil cooler
Separated engine hoods with gas spring. DPF hood screwed & protected
Upperstructure maintenance compartment doors and fuel cap lockable
Self-diagnostic function
Battery (12 V x 2, 150 Ah) with cut-off switch and alternator (24 V, 80 A)
Electric horn
Toolkit and spare parts for first service
Remote greasing for swing circle and workgroup pivot points
Guards for boom lights
Undercarriage
Front parallel dozer blade and rear independent stabilizers
Double tyres 10-20 14 PR
3 front axle oscillation lock modes (On/Off/Auto)
Piston rod protection of stabilizer cylinders
Lockable tool box (left side)
Rear & front chain tightening eyes

* Optional equipment

Cab & Interior
MP3/USB radio or MP3/USB radio with CD player
Safety
FOGS cab - top and front cab guards (ISO 10262)
Side view camera
2 Lateral safety bars (ISO 2867:2011)
Other
Hydraulic piping for crusher, quick coupler, clamshell, tilting and rotating buckets
Additional filter for breaker piping
One-piece boom 4600 mm – arm: 2100 mm
Two-piece boom 4988 mm (lower : 2000 mm, upper : 3350 mm) – arm: 2500 mm or 2100 mm
Doosan buckets: full range of GP, HD & Rock buckets
Doosan breaker and Doosan quick-couplers
Upper guard for front window
Lower guard for front window
Floating boom function
Wiper for lower front window
Double pump flow
Air compressor
Telescopic rotating beacon
Bio oil
Automatic lubrication system
Homologation preparation (depending on countries)
Undercarriage
Single tyres 18-19, 5 16 PR
Lockable tool box (right side)
Front cradle
2 or 4 independent stabilizers with cylinder protection
Rear parallel dozer blade



Microphone

For extra safety on crowded worksites.



2 additional lateral safety bars

With raised height for increased safety.



Air gun and compressor

Cleans dust inside cab and pump compartment. Cleans filter, radiator and oil cooler. Plugs available in cab, pump compartment and battery box.



Doosan buckets

A range of dependable new Doosan buckets is available to cover several applications.



Doosan breakers and quick-couplers

Doosan provides the tough, reliable equipment you need for demolition work.

Some of these options may be standard in some markets. Some of these options may not be available for certain markets. Please check with your local DOOSAN dealer for more information about availability or to adapt your machine to your application needs.

Doosan Infracore

The pulse of transformation



Construction Equipment

Machine Tools

Engines

The spirit of challenge and innovation has led Doosan. We started out as a small store in Seoul in 1896 and have expanded into a global company. Today we are engaged in the infrastructure support business (ISB), which encompasses industrial facilities, machinery, heavy equipment and construction. You can also see the Doosan brand in various other industries.

You are invited to take a closer look at the new world that is being built by Doosan, visit us at: www.doosaninfracore.com and www.doosanequipment.eu

Doosan Infracore Construction Equipment

A partner you can trust



**Finance
your
ambitions**



www.doosanequipment.eu

Financial Solutions

Doosan Infracore Financial Services (DI FS) is specialised in creating financing solutions to meet a wide variety of needs. Contact your local dealer for more information.

Always a dealer near you

Our well-developed dealer network has the knowledge and experience to take the best care of our Doosan customers. No matter where you are, you'll get the service you expect - and can rely on!

Parts & Service

- Complete parts & service support for all Doosan products
- Highest quality genuine parts
- Large, dedicated staff of factory-trained aftermarket professionals in the field



www.doosanequipment.eu