

Hiab 008 T

Capacity 0.9 tm



Hiab 008 T Basic data

Technical data

	008 T-0	008 T-1	008 T-2
Max. lifting capacity (kNm)	9.0	9.0	8.8
Outreach - hydraulic extensions (m)	-	1.9	2.8
Outreach - manual extensions (m)	3.8	3.8	3.8
Outreach / lifting capacity (m / kg)	-	1.1 / 840	1.1 / 840
	-	1.9 / 480	1.9 / 480
	-	-	2.8 / 320
Slewing angle	∞	322°	322°
Height in folded position (mm)	1228	1228	1228
Width in folded position (mm)	565	565	565
Installation space needed (mm)	-	-	-
Weight - "standard" crane without stabilizers (kg)	105	125	145
Weight - stabilizer equipment (kg)	12 - 15	12 - 15	12 - 15

Hiab 008 T-2

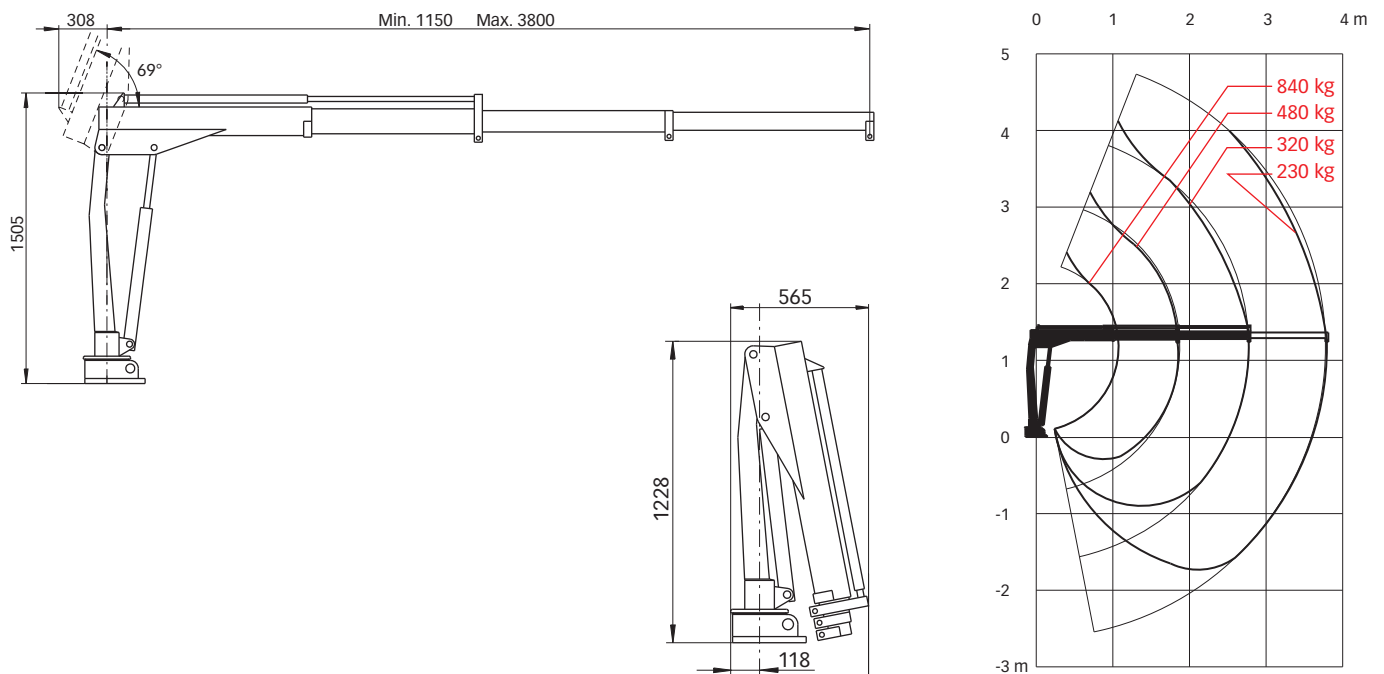

Disclaimer. Hiab cranes have been built to meet the highest standards of safety and service life and have been thoroughly tested. Strength calculations for this model have been carried out in accordance with DIN 15018 in fatigue class B2. Cargotec's certified Quality Assurance System complies with ISO 9001. Some of the items in our literature may be extra equipment. Certain applications may require an official permit. We reserve the right to change technical specifications without prior notice. Hiab cranes produced for EU-countries are CE-marked and comply with the European Standard EN 12999.

Cargotec improves the efficiency of cargo flows by offering solutions for the loading and unloading of goods on land and at sea – wherever cargo is on the move. Cargotec's main daughter brands for cargo handling Hiab, Kalmar and MacGregor are global market leaders in their fields. www.cargotec.com