



**74 to 114 kW (100 to 155 hp) (97/68 EC) 6030 Premium Tractors**  
**85 to 132 kW (115 to 180 hp) with Intelligent Power Management**



**JOHN DEERE**

The 6030 Premium Series are designed to deliver the versatility your operation demands. Innovative, Intelligent Power Management provides improved economy and increased power. Guidance and documentation solutions deliver more precision in the field. The cab has been redesigned with a new optional panorama door for enhanced comfort, productivity and control.

PowerTech Plus engines with intelligent Power Management give you up to 18 additional kW (25 hp) when you need it for heavy loads in transport and PTO applications.

John Deere engineers focused on every detail, from the position of controls to electrical connections to provide comfort and reliability. The end result? A tractor that will deliver the Premium Ownership Experience today and in the future.

**Seven Premium Models\***

- 6230P** – 74 kW/85 kW (100 hp/115 hp)
- 6330P** – 81 kW/92 kW (110 hp/125 hp)
- 6430P** – 92 kW/103 kW (125 hp/140 hp)
- 6534P** – 92 kW/107 kW (125 hp/145 hp)
- 6630P** – 99 kW/114 kW (135 hp/155 hp)
- 6830P** – 107 kW/125 kW (145 hp/170 hp)
- 6930P** – 114 kW/132 kW (155 hp/180 hp)

\* Horsepower figures shown are according to 97/68/EC at rated power in standard mode and at rated power in Intelligent Power Management mode.

**At A Glance –**

- Intelligent Power Management for added power when you need it
  - Comfortable cab interior
- Quality improvements for greater reliability

# PREMIUM OWNERSHIP EXP



# ERIENCE

**More  
reliability**



## **Introducing the new 6534 premium tractor**

*The new 6534 Premium tractor combines the economical, powerful 4.5 l, 4 cylinder John Deere PowerTech Plus engine with a large full frame chassis to meet customer expectations.*

*Based on the primary design of the John Deere modular-concept, our engineers developed a new breed of tractor. The 4.5 l PowerTech Plus engine with up to 145 hp\* provides excellent low fuel consumption. Combined with the larger full frame chassis with up to 250 l fuel tank capacity this tractor sets a new category of load carrying for longer days in the field or on the road with better traction and improved operator comfort. Get the 6534 and gain a clear advantage when it comes to efficiency.*

**Lower  
operating  
costs**



**Greater  
comfort**



## Table of Contents

Introduction	2-3
Concept	4-5
The Premium Ownership Experience	6-7
Low Operation Costs	8-9
Ag Management Solutions	10-11
John Deere PowerTech Plus Engines	12-13
Transmission Choices	14-15
Cab Interior	16-17
Primary Tillage Solutions	18-19
Seeding Solutions	20-21
Spraying Solutions	22-23
Transport Solutions	24-25
Grass and Straw Harvest Solutions	26-27
Front Loader Solutions	28-29
Specifications	30-31

## Relentlessly refined

How did John Deere engineers improve on these tractors?

They looked to the aerospace and automotive industries for inspiration, to design a cab interior with styling you'll appreciate as soon as you enter. They beefed up components, such as the TLS Plus panhard rod, to reduce maintenance and service needs.

They focused on the smallest details, including the electrical connections, wiring and load centres throughout the tractor to provide security and reliability.

The end result? A tractor you can depend upon, on the road or in the field.

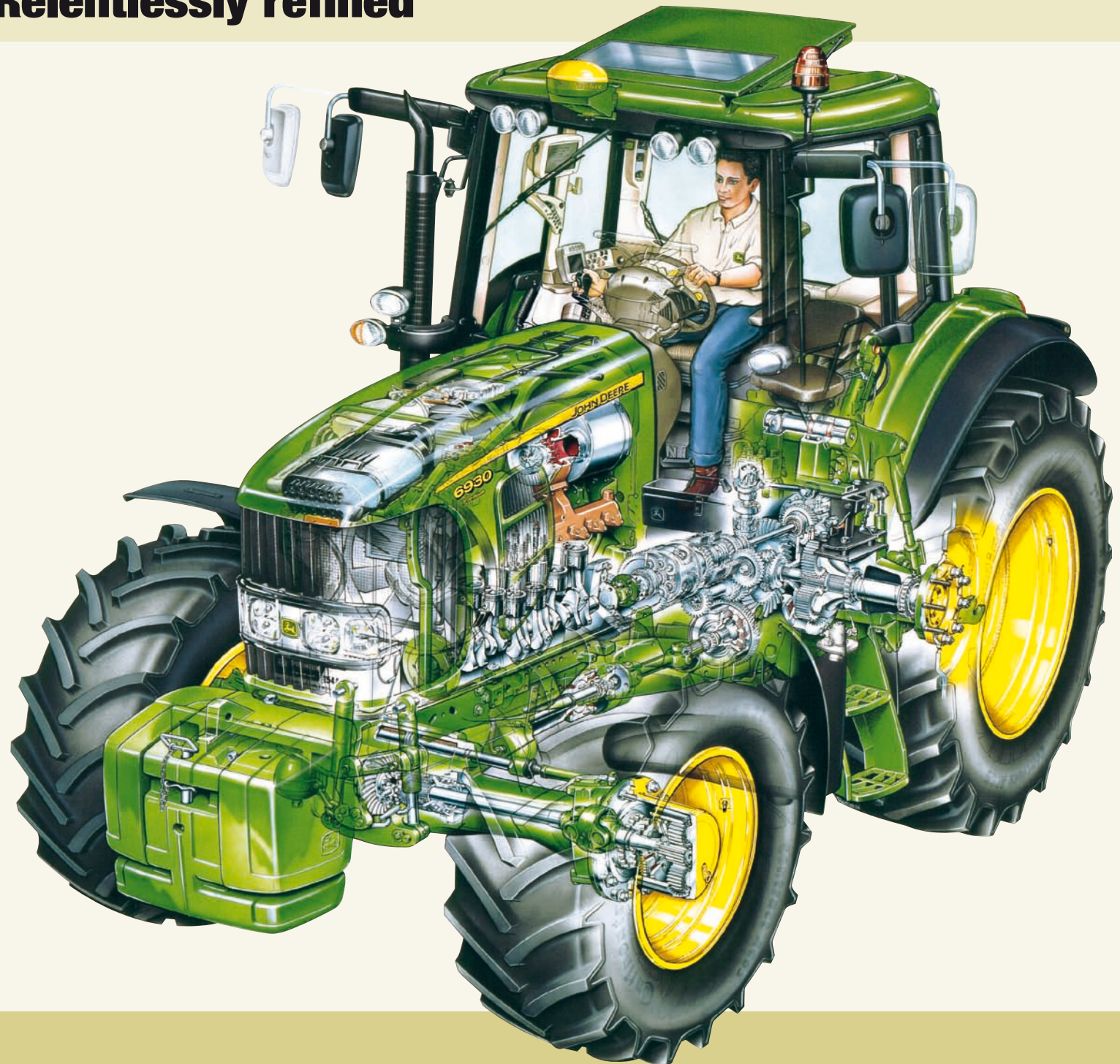

### **At A Glance –**

- Ergonomically redesigned cab interior with panorama door
- PowerTech Plus engines
- Declutch button for on-the-go shifting



### **Improved comfort**

- Ergonomically redesigned cab and controls
- CommandArm (available on all models above 6230) provides fingertip control and convenience
- Premium fit and finish reduces noise level
- Soft-touch textured controls

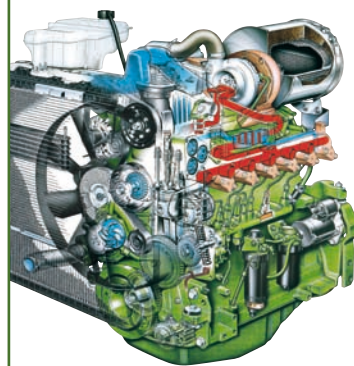

### **PowerTech Plus engine**

- 4V-CR design improves productivity and fuel economy
- Intelligent Power Management gives you up to 18 added kW (25 hp) when you need it most, transport and mobile PTO applications

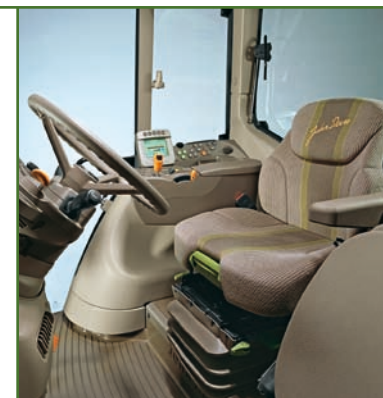

### **Enhanced visibility**

- Lowered control console profile gives you greater visibility to the sides of the tractor and implements
- Low-profile hydraulic valves provide better drawbar visibility
- Dashboard Instruments move with steering wheel

### **Ergonomic styling**

- Improved front, cab and roof lighting
- Stylish hood vents also deliver optimal cooling
- Hood wind split and decals instantly distinguish 6030 Premium Series



### **Ergonomic hydraulic controls/ergonomics**

- E-SCV controls available with or without CommandArm
- Hydraulic sway and top link control of rockshaft linkage
- Optional 110 L/min hydraulic flow



### **Driving Comfort**

- Hydraulic Cab Suspension smoothes out rough terrain
- Triple Link Suspension Plus (TLS) absorbs bumps for better traction and higher comfort level



## The John Deere experience

John Deere works hard to carefully craft and deliver quality, innovative solutions for the entire farm operation, from equipment to guidance systems to documentation software and more. This whole-system approach enables producers around the world to rely on us for their operational needs.

Owning a John Deere is more than owning a piece of equipment.

It's an unwavering commitment from your local dealer, the company and the vast worldwide network standing behind you.



### **At A Glance –**

- *Innovative, whole-system design*
- *Each tractor is tested to conform to John Deere quality standards*
- *A premier name in agricultural equipment worldwide*



*Precise tolerances and high specifications result in a fit and finish that you'll notice and appreciate – especially after a full day's work.*

*State-of-the-art design and manufacturing processes include a whole-tractor test facility. Tractors off the line are fully tested to ensure in-field performance and satisfy your exacting standards.*

*John Deere designs all and manufactures most of its own components, to control end quality. For example, PowerTech Plus engines are designed and built in-house, allowing our engineers to develop them to meet the rigorous demands of agricultural work.*

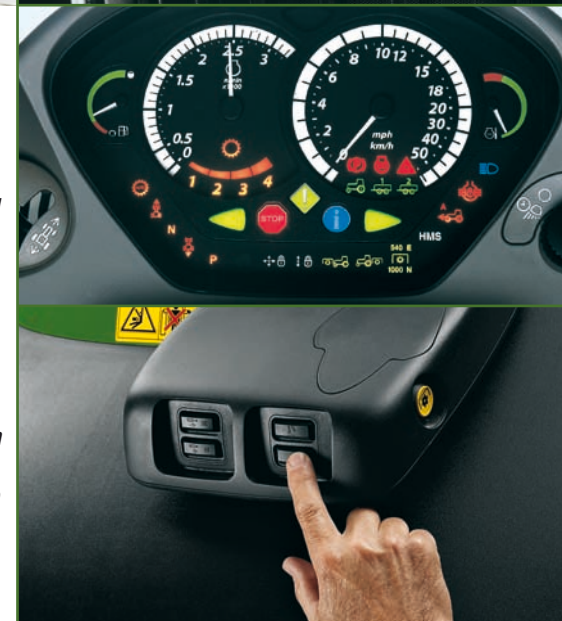

## Easy to own, easy to operate

Our 6030 Premium Series tractors deliver both low operating cost and low cost of ownership, so it's no wonder that producers around the world have made John Deere a premier name in agricultural equipment.

**Low operating costs.** Because input costs are not getting any lower, you'll appreciate our focus on reducing your costs for fuel, tyres, filters and more.

**Low ownership costs.** Our advanced engine and transmission technologies deliver very low ownership costs, with long service intervals, many maintenance-free components, quality design and construction and a dependable reputation that leads to a higher resale value.

**Lower costs, period.** Test drive a 6030 Premium Series tractor and you'll find it's truly as easy to own as it is to operate.

### At A Glance –

- Integrated equipment systems
- Low operating and service costs
- Easy purchase and maintenance plans make costs predictable







*John Deere equipment holds its resale value thanks to legendary quality, design and construction. Your purchase becomes an investment in your operation, not an expense.*

*With multiple service-free components and easy daily service points, you have more productive time in the field. For even greater peace of mind concerning time and costs, check with your dealer regarding the many maintenance plans available for up-front purchase.*



## Guidance you can grow with

When you make the move to precision farming, look to John Deere Agricultural Management Solutions (AMS). It all works with the GreenStar common components: The StarFire iTC DGPS receiver to pinpoint your exact in field location and a GreenStar display to monitor and control your field operation.

Start with Parallel Tracking, our satellite-based manual guidance system. By **reducing skips and overlaps**, it makes every pass more productive. When you're ready, use the components you already own and upgrade to hands-free guidance with AutoTrac assisted steering. AutoTrac reduces skips and overlaps by as much as 10%, thereby **saving you time, fuel and labour costs**. You'll also get **greater comfort and faster headland turns** because AutoTrac takes the guesswork out of your return path.

### *Signal accuracy options*

- **SF1 – FREE**, pass-to-pass accuracy  $\pm 30$  cm
- **SF2** – pass-to-pass accuracy of  $\pm 10$  cm
- **StarFire RTK** – Repeatable  $\pm 2$  cm accuracy





## iGuide

With iGuide you can now experience highest precision standards in all your seeding, planting and tillage operations. Irrespective of your terrain, iGuide keeps your implement on track. In uneven terrain the weight of your pull-type implement will cause it to drift. The result is gaps and overlaps that affect the quality of your work. With iGuide, the tractor now changes its path to compensate for implement drift in uneven terrain and slopes and guides the implement to a perfect pass-to-pass result.

## FieldDoc Data Collection

Turn your tractor into an information gathering machine with FieldDoc. Working with your StarFire iTC receiver and GreenStar 2600 monitor, FieldDoc simplifies in-cab data collection such as field boundaries, tillage practices, seed varieties, fertiliser type, application rates and crop protection records.

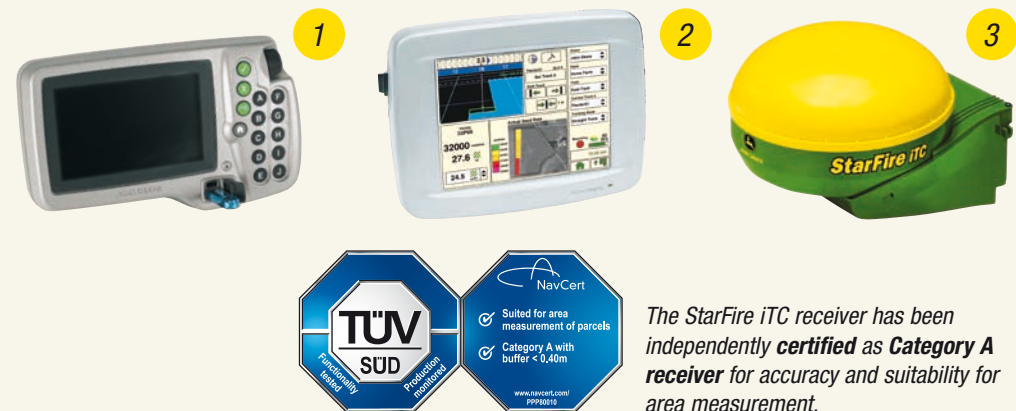

The StarFire iTC receiver has been independently certified as **Category A receiver** for accuracy and suitability for area measurement.

## GreenStar Common Components

- 1 **The GreenStar 1800 Display** is easy to use and can quickly be moved from one vehicle to another across your fleet. GreenStar 1800 is ISOBUS compatible and allow you to control ISOBUS implements. With this Display you can also run guidance applications like ATU 200, AutoTrac, Parallel Tracking and Sprayer Pro.
- 2 **4 in 1 – The GreenStar 2600 display** brings you four features in only one display. It gives you full control of all your guidance applications, is ISOBUS conformed and comes pre-loaded with field documentation to boost productivity. It can also act as a tractor performance monitor. With the GreenStar 2600 display, your tractor is fully prepared to optimise machine performance (guidance applications and performance monitor), document critical field tasks (FieldDoc) and control of your ISOBUS implements.
- 3 **The StarFire iTC position receiver** pinpoints your exact in field position for all your guidance and documentation features. With its integrated Terrain Compensation module it can correct all position calculations to adjust for uneven ground and slopes providing you with precision guidance and more accurate readings.

## JLink

If you manage a fleet of tractors, JLink helps you track all your machines from the convenience of your office. JLink gives you or your dealer visibility to live tractor performance data, detailed service records and precise vehicle location.

# Smarter power with Intelligent Power Management

PowerTech Plus engines with Intelligent Power Management give you added power, in addition to extra power and constant high torque characteristics of the 4V-CR design.

When pulling heavy trailers, baling on steep slopes or mowing, there are times when you can use Intelligent Power Management (IPM) to maintain full productivity.

Our engines also feature proven technologies, such as a Variable Geometry Turbocharger, Exhaust Gas Return and Charge Air Cooler. These components deliver superior engine response and torque characteristics, while improving fuel economy.

**4-CYLINDER:**  
74 to 92 kW (100 to 125 hp) rated  
85 to 107 kW (115 to 145 hp) rated with  
Intelligent Power Management (in mobile PTO and  
transport applications)

**6-CYLINDER:**  
99 to 114 kW (135 to 155 hp) rated  
114 to 132 kW (155 to 180 hp) rated with  
Intelligent Power Management (in mobile PTO and  
transport applications)

### At A Glance –

- Intelligent Power Management delivers up to an additional 18 kW (25 hp) in transport and mobile PTO applications
- 4V-CR design for high performance and fuel economy

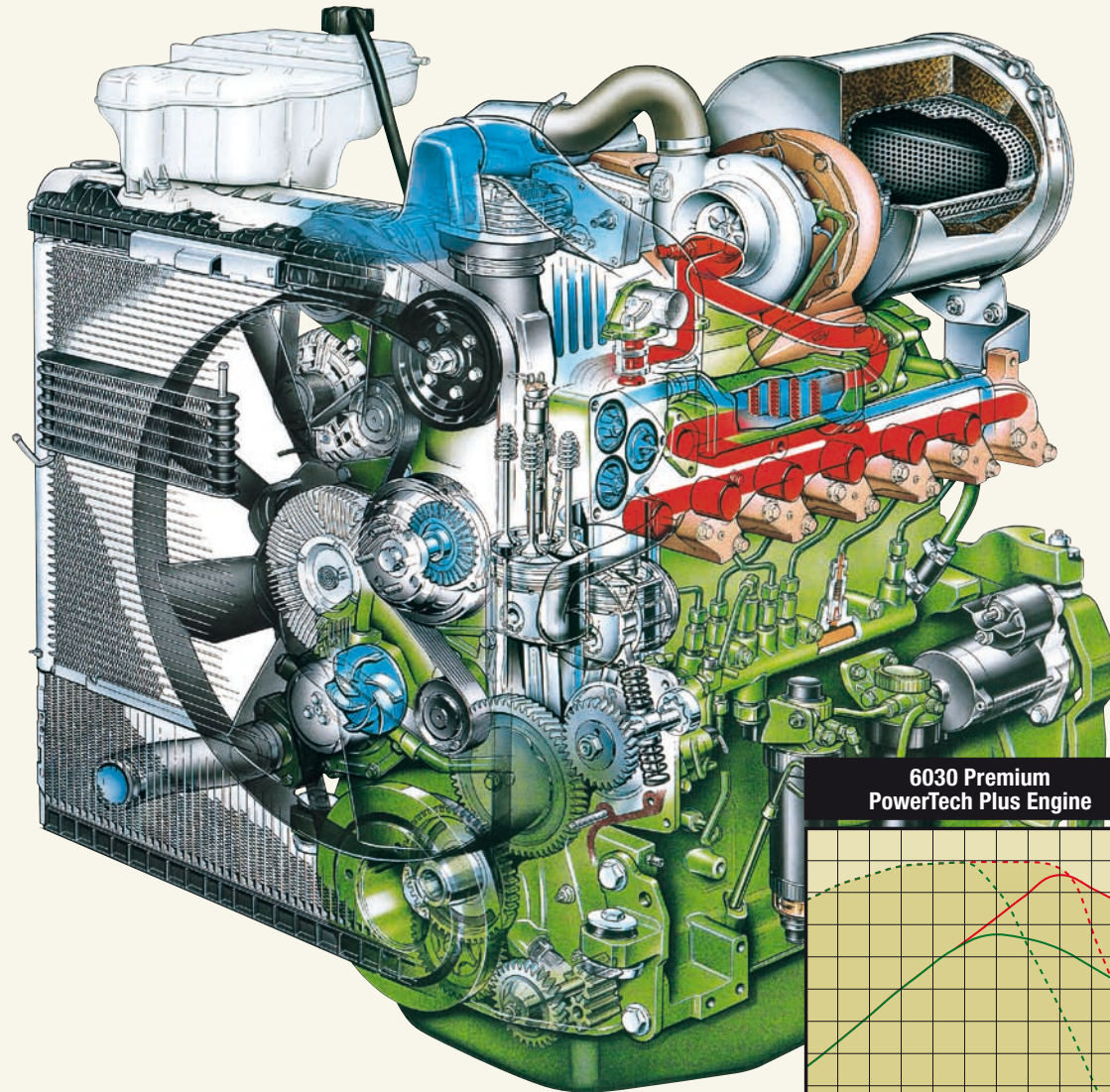

6030 Premium  
PowerTech Plus Engine



Up to 35% engine torque rise helps you pull through tough conditions.

- Torque without Intelligent Power Management
- Torque with Intelligent Power Management
- Power without Intelligent Power Management
- Power with Intelligent Power Management

**Intelligent Power Management** gives you up to 18 additional kW (25 hp) to handle high loads in transport and heavy PTO applications. Plus, extra power – up to 7% – is still available for heavy draft applications and towed equipment.

**PowerTech Plus Engine can improve your bottom line profits**

- **Power when you need it** – extra power of up to 7%, plus Intelligent Power Management provides up to 18 kW (25 hp) more, so you'll always have power in reserve.
- **Four Valve-CommonRail (4V-CR) design** uses four valves per cylinder and high pressure common rail fuel delivery to ensure instant response to varying load conditions. You get improved productivity and fuel economy.
- **Variable Geometry Turbo-charger (VGT)** provides excellent low speed torque, improved engine response and enhanced fuel economy.
- **Exhaust Gas Recirculation (EGR)** – proven on-highway technology improves fuel economy, and reduces emissions.
- **Charge Air cooler** with twin coolant pass system for accurate temperature control, providing performance and fuel efficiency.





# Easy, Precise Control.

Whether operating the tractor all day or guiding a fleet of operations, you can select the appropriate transmission with your operations in mind. John Deere delivers easy to control, precise transmissions for all applications.

Whether you choose the advanced AutoPowr with infinite speed selection, the proven PowrQuad Plus or the best of both worlds, AutoQuad Plus, you get highly efficient transmissions that let you optimise in-field or on-road productivity.



## PowrQuad Plus Transmission

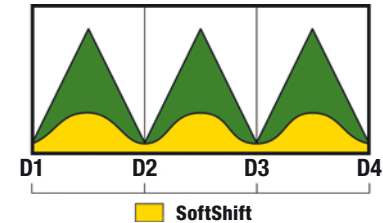

**Get a smooth gear change, even under load, thanks to SoftShift.**  
 Our advanced John Deere engine/transmission team integrates the engine in shifting operations, briefly and automatically adjusting engine speed to create a smooth shift. Standard on both PowrQuad Plus and AutoQuad Plus Transmissions, for comfort nearly equal to the AutoPowr Transmission.



**An all-new declutch button** on PowrQuad Plus and AutoQuad Plus transmissions allows you to conveniently shift ranges, on-the-go, with the click of a button.

### At A Glance –

- Three transmission choices: PowrQuad Plus, AutoQuad Plus and AutoPowr
- Easy to use operator interface



## AutoQuad Plus Transmission

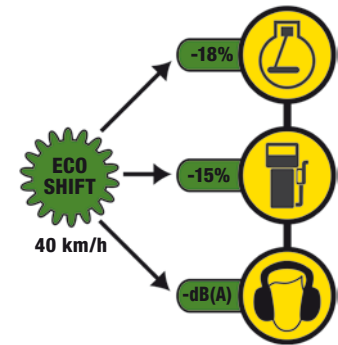

**ECOSHIFT** lets you travel at high transport speeds at lower engine rpm to achieve greater operator comfort and reduce fuel consumption. It's available for the 40K AutoQuad Plus Transmission.



*The AutoPowr speed control lever has been ergonomically redesigned for even greater comfort and ease of use. It's just another example of the attention to detail you'll find in these tractors.*



### AutoPowr Transmission

Tractor transmission technology has never been so easy to use.

AutoPowr can be driven by anyone within a few minutes of sitting in the seat. A single lever lets you shift smoothly from 0 to 40 or 50 km/h ... and any speed in between. There's absolutely no clutching required, even to stop the tractor. You can dial in a specific speed and the transmission and engine work together to keep the tractor in balance, with worry-free, instant and automatic response to changing load conditions.

With our PowerZero feature, you can hold the tractor at zero speed – that means no rollbacks, even on inclines regardless of load.



*AutoPowr lets you fine-tune the transmission and engine performance to meet your needs for optimal economy and productivity.*

# Comfort, convenience and control

Your first step into a 6030 Premium Series tractor cab will tell you this is no ordinary operating environment. From the fit and finish to the soft-touch textured surfaces, you'll appreciate the quality of your operator station.

Go ahead – adjust the air suspension seat. Tilt and telescope the steering wheel (notice the instrument pod and left-hand reverser stay with the wheel!). Dial in a desired temperature for automatic temperature control. Use the built-in cooler or conveniently placed cup-holder.

Plus, we've added an optional panorama door to help you feel even more at home in this tractor. With the wide expanse of glass, you'll get nearly 360 degrees of clear visibility. On cold days, turn on the heated seat.

And we haven't even begun yet to describe the enhanced visibility, ergonomic controls, innovative CommandCenter or convenience of CommandArm.



*Enter the cab from either side with the all-new panorama door and increase your visibility to the front, side and rear.*



*Choose M-SCV (left) or E-SCV (right) hydraulic controls. Both are positioned for quick use and precise implement adjustment.*



- Easy to read automotive style dashboard moves with the steering wheel to maintain visibility and placement of controls in relationship with the steering wheel.
- Air suspension seat minimises operator fatigue from the bumps and jolts of work. For wintry days, the heating option makes working in the cold more comfortable.
- 100 mm cab suspension option further reduces vibration, noise and provides a comfortable environment from start to finish of the working day, either on the road or in any field application.
- An improved sound system with greater reception and reduced cab noise provides a greater level of comfort and enhances longer working days.

### At A Glance –

- New panorama door option for nearly 360 degrees of visibility
- CommandCenter optimises tractor performance
- Finger-tip-convenient controls





- **View vital operational data**, such as speed, rpm, fuel level and pressure levels on the CommandCenter.
- **Observe even more data** through CommandCenter – programmable hot keys quickly bring up the information you want.
- **ClimaTrak** automatic temperature control lets you specify a temperature and the system keeps it there, automatically adjusting vents and blowers as needed.



**CommandCenter.** This easy to use terminal uses a full-colour display to let you quickly optimise the tractor for operational conditions.

- 1 **Programmable hot keys** take you to frequently adjusted controls, such as lighting or hydraulic functions as you desire.
- 2 **The low profile right hand control console** provides increased visibility to the side for those mowing applications.
- 3 **Tilt CommandCenter** for easy, at-a-glance views.
- 4 **Closely arranged controls for the Command Centre** provide easy to use and quick access to use the rotary selector wheel and menu setting, select/enter and cancel buttons for quick navigation to control tractor and implement function.

Primary tillage applications such as ploughing demand heavy lugging power and the ability to cope with changing soils.

Our 6030 Premium Series tractors provide the advantages in all conditions. Rugged 4V-CR PowerTech Plus engines deliver greater levels of torque and power. The deeper breathing characteristics of four valves-per cylinder result in constant high torque performance across the entire working range of the engine.

Combined with the pulling power of Triple Link Suspension Plus (TLS) and the optimal geometry of the 3-point hitch, you can stay productive, even in the most challenging conditions.

# Experience power in all conditions

*The reliable, self adjusting PermaClutch II features large diameter discs to provide ample surface area to transfer power effectively. Cooled and filtered oil services the clutch after each engagement to help prevent heat build-up. You get long lasting performance and smooth modulated engagements.*

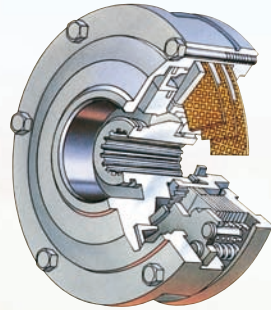

### At A Glance –

- Optimised **3-point-hitch** for capacity and performance
- Rugged TLS Plus improves traction and pulling power

*The 3-point-hitch geometry is ideally positioned to take advantage of the relationship between the linkage and the TLS Plus axle. The entire tractor works together to deliver maximum performance.*



*With a lift capacity of up to **8400 kg**, you can raise heavy or loaded implements with ease. Hydraulic centre-link and sway control lets you adjust the geometry to match implement usage.*

*The **service free panhard rod** provides stability and uses maintenance-free bushings for greater service life.*

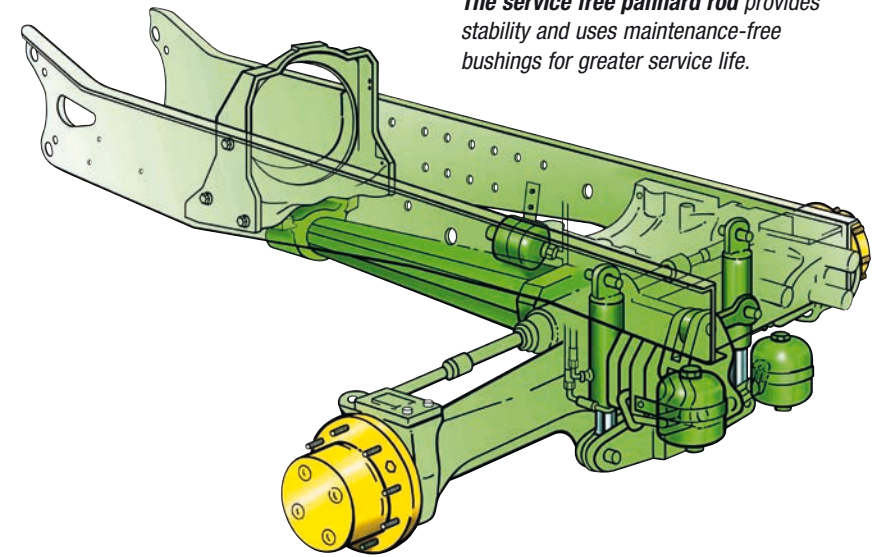

***Triple Link Suspension Plus** is a true suspension system, so front wheels follow the ground contours. It absorbs bumps hydraulically instead of passing them to the frame and cab. You maintain better traction and increase pulling power. Plus, you can increase operating speed and comfort level. Select from three modes: Auto, Max and Manual.*

- **Auto Mode** uses frequency and position sensors for dynamic control in all conditions.
- **Max Mode** “stiffens” the front axle suspension for accurate working activities, such as front loader applications where pallet placement is important.
- **Manual Mode** enables full manual control of the suspension height for attaching front equipment

## Experience unparalleled convenience

At seeding time, it's not uncommon to be running in the field from before sunrise to well after sunset – sometimes, the tractor only stops to change operators.

A 6030 Series tractor can't stop time but it'll make long hours in the cab much more pleasant.

For instance, HMS Plus (Headland Management System) lets you perform multiple functions with the push of a button.

Choose from two innovative hydraulic control types.

Electrical selective control valve, E-SCV or mechanical selective control valve M-SCV. Both control levers offer convenient placement. E-SCVs can also be programmed to adjust hydraulic flow and time.

And these tractors are ISOBUS compatible, for integration with your implements.

### **At A Glance –**

- HMS Plus gives you one-touch operation of multiple sequences
- Conveniently placed hydraulic controls make adjustments easy
  - ISOBUS compatible



# Headland Management System



**More productive tractors, more productive operations** with HMS Plus (Headland Management System). This reduces operator fatigue, especially at headlands, by sequencing multiple tractor functions into one button. Simply programme the operations you need, raising the implement, disengaging the PTO and differential lock and more, all through the convenience of the CommandCenter. Select one of the programmable hot keys to start the sequence or reverse it with push button ease.



**E-SCVs are available**, located on the right-hand control console, ergonomically designed for fingertip hydraulic control. Or, choose the CommandArm console for even greater convenience. Operate with ease and confidence.



**Fender mounted remote switches** allow you to control the rear hitch and PTO during implement attachment. Optional top link control is available.



**Pivoting front-wheel fenders** are designed to provide greater coverage area to limit flying debris while moving away from the frame to allow tighter turns.

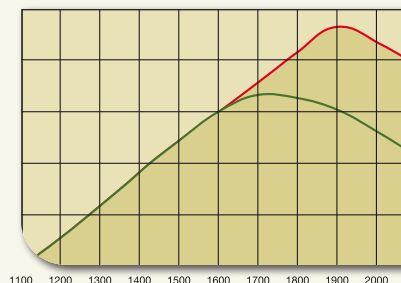

**Intelligent Power Management** delivers up to 18 additional kW (25 hp) during mobile PTO operations. You'll have plenty of reserve power for tough, wet soils or terraces.

— Without Intelligent Power Management  
 — With Intelligent Power Management

## Experience greater productivity

When the window of opportunity for crop care narrows, make the most of your time with a 6030 Premium Series tractor.

Intelligent Power Management gives you power when you need it, such as pulling a trailed sprayer. You get up to 18 additional kW (25 hp) to maintain constant speed, even in challenging conditions, such as operating on a steep incline.

Integrated guidance solutions such as Parallel Tracking and AutoTrac help you reduce overlap and optimise in-field time. You'll finish your fields faster and reduce input costs.

And with the optional hydraulically suspended cab, you'll float over rough terrain and enjoy a smooth ride with less fatigue.

### **At A Glance –**

- *Intelligent Power Management gives you added power in mobile PTO applications*
  - *Integrated guidance solutions reduce overlaps*





**Parallel Tracking and AutoTrac** help you reduce input costs, overlap and time spent in the field. These solutions integrate perfectly into the tractor, since they're from John Deere, not a third party.



**Go when conditions are perfect, even into the night.** Roof and beltline mounted lights extend your visibility range. Optional high intensity discharge lighting makes it even easier to see during those long working nights.



**The large capacity fuel tank** together with Intelligent Power Management and high pressure common rail fuel delivery lets you extend operating times if needed.

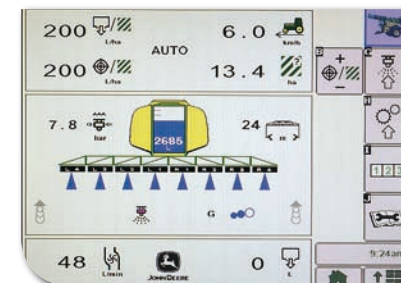

**ISOBUS compatibility** means you can control any ISOBUS implement. You can control implement functions through the CommandCenter. Programme a hot key to take you to the control screen for easy adjustments.

## The ultimate driving experience

Our 6030 Premium Series tractors shine on the open road, with power and features to make transport duties easier and with greater driving comfort.

Intelligent Power Management gives you up to 18 additional kW (25 hp) for transport applications, making it easier to maintain speed. Wheels and tyres are laser aligned at the factory – this system matches the wheel to the tyre for optimum roundness and high speed capability.

For sure stops, even with loaded trailers, hydraulic air brakes and front axle brakes can be equipped. And optional Triple Link Suspension Plus and Hydraulic Cab Suspension minimise vibrations and ensure a smooth ride.

### At A Glance –

- Intelligent Power Management gives up to 18 additional kW (25 hp) for transport
- Laser-aligned wheels/tyres and suspension options give a smooth ride







*Easily start and stop with the unique features of the AutoPowr transmission. PowerZero lets you hold the tractor and load at zero speed, even on an incline. The integrated AutoClutch feature automatically engages when you step on the brakes.*



*TLS Plus and Hydraulic Cab Suspension smooth out rough terrain to allow for fast, controlled transport with greater operator comfort.*

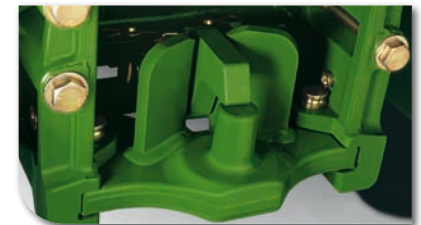

*As versatile as you need. The unique three-in-one hitch rail lets you use a variety of connections, from pick-up to ball, wagon to pylon. No matter what system you use, these tractors can accommodate it.*

## Experience relaxed work, even when time is critical

When the weather threatens, you need to finish baling on time to preserve nutrients and palatability. Our 6030 Premium Series tractors let you stay one step ahead.

Intelligent Power Management gives you up to 18 additional kW (25 hp) when you need it most. For instance, to maintain speed on inclines or when baling heavy windrows without lugging down.

Plus, a power-assisted PTO speed change system makes it easier to move between implements, making PTO speed selection as simple as pressing a button.

### At A Glance –

- Intelligent Power Management gives you added power during baling
- Power-assisted PTO speed change makes implement changes easy.



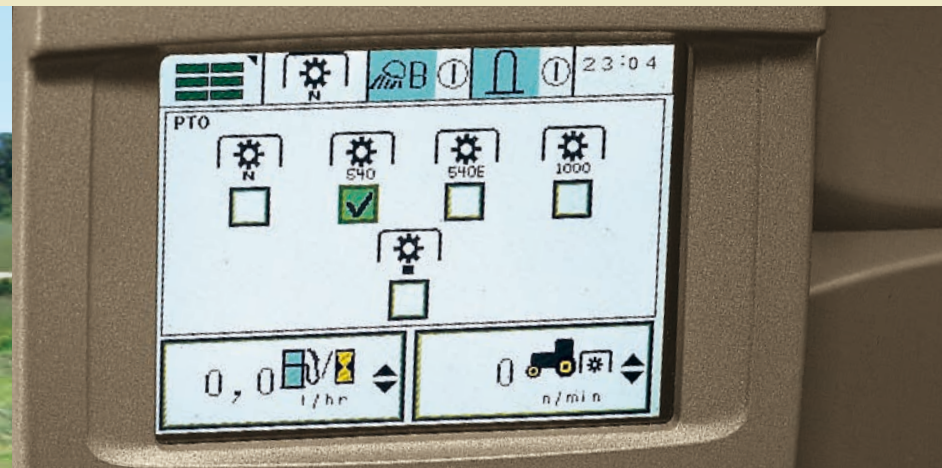

*Power-assisted PTO speed changes make it easy to switch between implements. The CommandCenter lets you select from 540, 540E and 1000 rpm operation. Programme a hot key to immediately take you to the adjustment screen.*



## Experience greater durability and versatility

When it comes to moving material such as silage, feed or manure, the innovative design of our 6030 Premium Series tractors give you an advantage.

The full-length frame has been proven to add years of reliable service by protecting drivetrain components from load stresses. PermaClutch II is maintenance-free to reduce service needs.

Plus, controls such as the left hand reverser and joystick are integrated for convenience and comfort.

Pressure-and-flow compensated hydraulics make cycle times faster. Loader visibility forwards and through the roof is outstanding, with a reduced header profile.

### **At A Glance –**

- Full-frame, long-life design concept ensures years of service
- Standard left-hand reverser, integrated joysticks and great visibility make loader work quick and easy.



### Tractor Loader compatibility

		6130P 6230	6330 6430	6530 6630 <sup>u</sup>	6830	6930
583	NSL	0*				
	MSL	900*				
	HSL	900*				
633	NSL	900	0			
	MSL	900	900			
	HSL	900	900			
653	NSL	900	900	0		
	MSL	1150	900	0		
	HSL	1150	900	0		
663	MSL			900		
683	NSL	900	900	0	0	
	MSL			1150	900	
	HSL			1150	900	
753	MSL					1150

NSL – Non Self Leveling loader  
MSL – Mechanical Self Leveling loader  
HSL – Hydraulic Self Leveling loader

Note: contact your dealer for further information and detailed specifications.

### Rear ballast required in kg

0	Compatible without ballast
900	Compatible with John Deere ballast of 900 kg
1150	Compatible with John Deere ballast of 1150 kg



**Greater visibility.** In addition to a slimmer header profile, choose a glass roof hatch. Open either to the back for visibility and ventilation.



**The integrated joystick** provides convenient operation, plus unrestricted movement in the cab. Auxiliary hydraulic function buttons on the front of the joystick make it easier for you to operate attachments such as a grapple or silage defacer.



**Make fast and easy direction changes with the left-hand reverser.** The AutoPowr transmission left-hand reverser features a PowerZero position that allows you to hold the tractor at zero speed. You can drive into a pile and still have full power to get a full load every time.

# Specifications

	6230	6330	6430	6534	6630	6830	6930
<b>ENGINE PERFORMANCE</b>							
Rated power (97/68 EC)	74 kW (100 hp)	81 kW (110 hp)	92 kW (125 hp)	92 kW (125 hp)	99 kW (135 hp)	107 kW (145 hp)	114 kW (155 hp)
Maximum power (97/68 EC)	79 kW (107 hp)	87 kW (118 hp)	98 kW (134 hp)	98 kW (134 hp)	106 kW (144 hp)	115 kW (156 hp)	123 kW (167 hp)
Rated Intelligent Power Management 97/68EC (in mobile PTO and transport applications)	85 kW (115 hp)	92 kW (125 hp)	103 kW (140 hp)	107 kW (145 hp)	114 kW (155 hp)	125 kW (170 hp)	132 kW (180 hp)
Rated power (ECE-R24)	70 kW (95 hp)	77 kW (105 hp)	88 kW (120 hp)	88 kW (120 hp)	95 kW (129 hp)	103 kW (140 hp)	110 kW (150 hp)
Maximum power (ECE-R24)	75 kW (102 hp)	83 kW (113 hp)	95 kW (129 hp)	95 kW (129 hp)	102 kW (139 hp)	110 kW (150 hp)	118.5 kW (161 hp)
Rated Intelligent Power Management ECER24 (in mobile PTO and transport applications)	81 kW (110 hp)	88 kW (120 hp)	96 kW (131 hp)	101 kW (138 hp)	110 kW (150 hp)	120 kW (163 hp)	129 kW (175 hp)
Maximum Torque	416 Nm	455 Nm	518 Nm	518 Nm	557 Nm	657 Nm	700 Nm
Constant power range	600 rpm	600 rpm	600 rpm	600 rpm	600 rpm	550 rpm	550 rpm
Torque Reserve	35%	35%	35%	35%	35%	35%	35%
<b>ENGINE SPECIFICATIONS</b>							
Rated speed	2300 rpm	2300 rpm	2300 rpm	2300 rpm	2300 rpm	2100 rpm	2100 rpm
Type	PowerTech Plus, CommonRail, 4 Valves, Stage III A Emissions Certified						
Aspiration	Variable Geometry Turbocharger with Intercooler and Cooled Exhaust Gas Recirculation (EGR)						
Cylinder and Displacement, ccm	4/4530	4/4530	4/4530	4/4530	6/6788	6/6788	6/6788
Cooling fan drive	Temperature controlled viscous fan						
Fuel Injection system & Control:	High Pressure CommonRail						
Fuel Tank Capacity	185 l	185 l	185 l	207/250 l	207/250 l	250/325 l	250/325 l
<b>TRANSMISSIONS OPTIONS</b>							
<b>PowerQuad Plus</b>							
20/20 2.5 – 40 km/h	–	–	–	–	–	●	●
24/24 1.6 – 40 km/h	●	●	●	●	●	–	–
<b>AutoQuad Plus</b>							
20/20 2.5 – 40 km/h or 2.5 – 50 km/h	–	–	–	–	–	●	●
24/24 1.6 – 40 km/h	●	●	●	●	●	–	–
24/24 2.0 – 50 km/h	●	●	●	●	●	–	–
<b>AutoQuad Plus ECO SHIFT</b>							
20/20 2.5 – 40 km/h	–	–	–	–	–	●	●
24/24 2.0 – 40 km/h	●	●	●	●	●	–	–
<b>AutoPowr</b>							
50 m/h – 40 km/h or 50 km/h	–	●	●	●	●	●	●
Creeper (PowerQuad Plus, AutoQuad Plus and AutoQuad Plus Ecoshift)	●	●	●	●	●	●	●

	<b>6230</b>	<b>6330</b>	<b>6430</b>	<b>6534</b>	<b>6630</b>	<b>6830</b>	<b>6930</b>
<b>PTO – REAR</b>							
Type	Electro-hydraulically operated oil cooled multi-disc clutch						
540/540E/1000 Rear PTO at rated PTO speeds	2143 / 1684 / 2208	2143 / 1684 / 2208	2143 / 1684 / 2208	2143 / 1684 / 2208	2143 / 1684 / 2208	1995 / 1743 / 1995	1995 / 1743 / 1995
<b>HYDRAULIC SYSTEM</b>	PFC System (pressure and flow compensating), load sensing						
Maximum flow	71/110 l	71/110 l	71/110 l	71/110 l	71/110 l	71/110 l	71/110 l
Selective Control Valves							
Maximum SCV's	4	4	4	4	4	4	4
<b>3-POINT HITCH – Rear</b>	II / III N	III N	III N	III N	III N	III N/ III	III N/ III
Type	Electronic lower link; load & depth control, infinite mix, float						
Maximum lift capacity at hooks	49.8 / 57.2 kN	57.2 kN	57.2 kN	64.6 kN	72.4 kN	75.2 / 84.3 kN	75.2 / 84.3 kN
<b>FRONT AXLES</b>	TLS Plus TRIPLE LINK SUSPENSION						
Design	Hydro-pneumatic, permanent active, triple link; self-levelling; accumulators						
Suspension system	100 mm suspension range						
Brakes (option)	Increased braking capacity by additional brake discs in the axle hubs						
<b>CAB</b>	Tilttable cab; 310° all-round vision; telescoping and tilttable steering column/wheel; 2 storage compartments; opt. FieldOffice						
Type							
Sound Reduction / Level	70.6 dB(A)	70.6 dB(A)	70.6 dB(A)	70.6 dB(A)	70.6 dB(A)	70.6 dB(A)	70.6 dB(A)
Display	CommandCenter and dashboard						
<b>SERVICE INTERVALS AND QUANTITIES</b>							
Engine oil	500 h, 16 l	500 h, 16 l	500 h, 16 l	500 h, 16 l	500 h, 19.5 l	500 h, 19.5 l	500 h, 19.5 l
Engine Coolant	1500 h, 24 l	1500 h, 24 l	1500 h, 24 l	1500 h, 24 l	1500 h, 28 l	1500 h, 28 l	1500 h, 28 l
Transmission, final drive and hydraulic oil (with AutoPowr)	1500 h, 53 l	1500 h, 53 / 62 l	1500 h, 53 / 62 l	1500 h, 53 / 62 l	1500 h, 53 / 62 l	1500 h, 56 / 66 l	1500 h, 56 / 66 l
<b>DIMENSIONS AND WEIGHTS</b>							
Wheelbase, mm	2400	2400	2400	2650	2650	2650	2650
Width x Height x Length	2275 x 2714 x 4289 mm	2275 x 2714 x 4289 mm	2316 x 2742 x 4289 mm	2316 x 2742 x 4289 mm	2316 x 2742 x 4289 mm	2382 x 2906 x 4758 mm	2382 x 2906 x 4758 mm
With tyre size	14.9R24 and 16.9R38	14.9R24 and 16.9R38	16.9R24 and 18.4R38	420/70R28 and 18.4R38	420/70R28 and 18.4R38	16.9R28 and 20.8R38	16.9R28 and 20.8R38
Minimum shipping weight	4390 kg	4540 kg	4750 kg	4950 kg	5230 kg	5580 kg	5880 kg
Maximum Permissible Gross Weight at 40 km/h	8000 kg	9000 kg	9000 kg	9500 kg	10000 kg	10500 kg	11000 kg

Specifications and design subject to change without notice.

## Experience a premium partnership

When it comes to in-field support, nothing matches the reliability of your John Deere dealer. Whether it's service after the sale, a critical part needed for any of your equipment, regular tune-ups or emergency repair, your dealer stands ready to deliver the prompt and friendly service that's the hallmark of John Deere. It's all part of our long-term commitment to your success.

### **The long green line –**

*No matter what your power requirements, John Deere has the products and services you need to run a successful operation. In the 100 to 155 hp range, choose from seven different models in the Premium Series.*

### **At A Glance –**

- A worldwide network of dealers ensures support wherever you need it
- Unparalleled parts service and availability, even when the dealership is closed



**JOHN DEERE CREDIT**

### **"Take the credit for buying the best"**

John Deere Credit – A range of finance options as powerful as our products. Contact your John Deere dealer for a comprehensive range of finance options to suit the specific needs of your business.

Not available in all countries please consult your local dealer.

This literature has been compiled for worldwide circulation. While general information, pictures and descriptions are provided, some illustrations and text may include finance, credit, insurance, product options and accessories NOT AVAILABLE in all regions.

PLEASE CONTACT YOUR LOCAL DEALER FOR DETAILS. John Deere reserves the right to change specification and design of products described in this literature without notice.

"John Deere's green and yellow colour scheme, the leaping deer symbol and JOHN DEERE are trademarks of Deere & Company."



**JOHN DEERE**

**RELIABILITY IS OUR STRENGTH**

[www.JohnDeere.co.uk](http://www.JohnDeere.co.uk)  
[www.JohnDeereInternational.com](http://www.JohnDeereInternational.com)  
[www.JohnDeere.co.za](http://www.JohnDeere.co.za)  
[www.Deere.com.au](http://www.Deere.com.au)