

◇ 1.1x1.1  
SF1100

■ 1.21x1.21  
SH1210

◇ Hg (m)		■ Hg (m)	
FEM	○	FEM	○
CATR	17.4	CATR	36.7
CAF	28.7	CAF	41.7
TEF	28.5	TEF	41.5
TRF	28.5	TRF	41.5

①

▤ CATR  
⤿ CATC

CAF

TEF

TRF

PRT-TR

PRT

Power Control

ASsys

ACsys

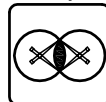

FEM 1.001 - A4  
EN 14439 - C25 - D25

Torre/Reazioni – Masts/Reactions – Mat/Réactions – Maste/Eckdrücke – Mästil/Reacciones – Tramo/Reacções

SF1100 FEM

○ Hg=Ht-1 m

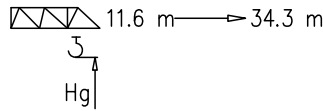

3	ST058	1/1
2	BA058	2/1
1	B0058	2/2

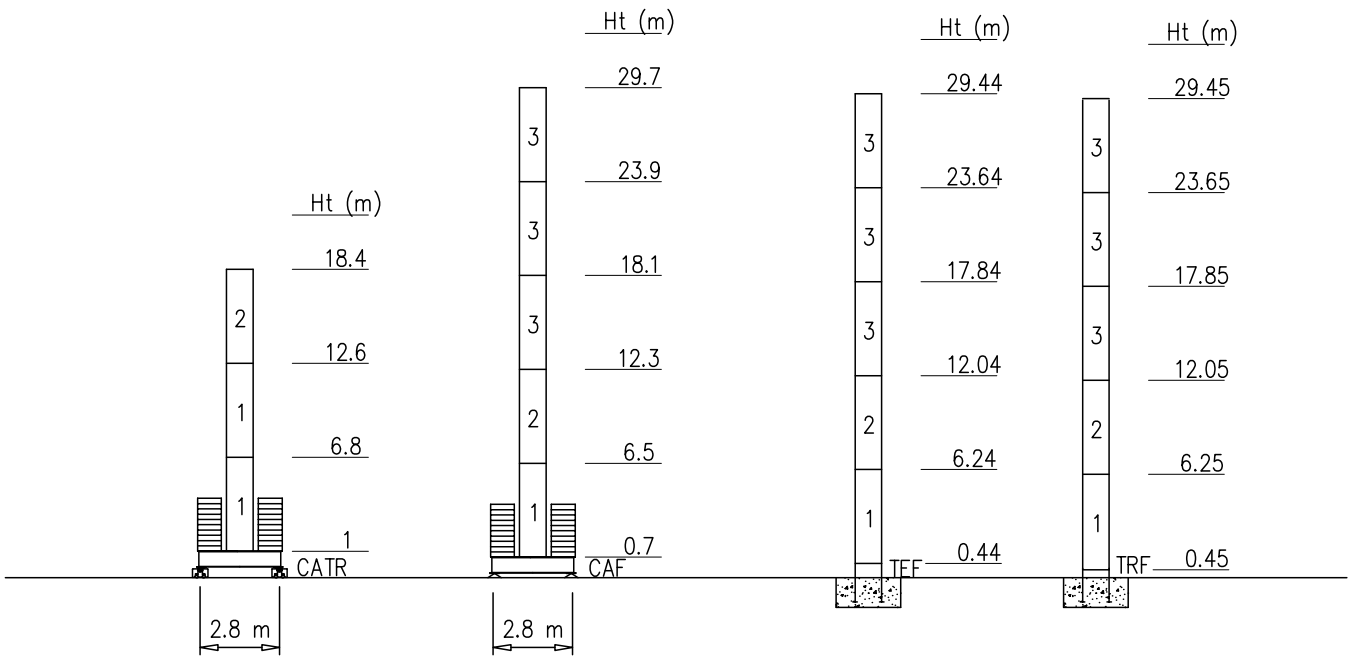

Peso zavorra – Ballast weight – Poids du lest – Ballastgewicht – Peso de lastre

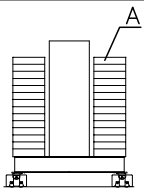

SF1100	
H-CATR (m)	18.4
FEM (t)	26.4
n°	12xA

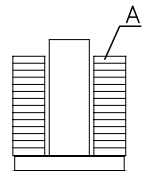
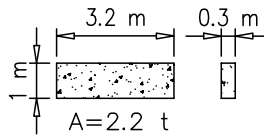

SF1100			
H-CAF (m)	12.3	23.9	29.7
FEM (t)	22	26.4	30.8
n°	10xA	12xA	14xA

Torre/Reazioni – Masts/Reactions – Mat/Réactions – Maste/Eckdrücke – Mästil/Reacciones – Tramo/Reacções

SH1210 FEM

○ Hg=Ht-1 m

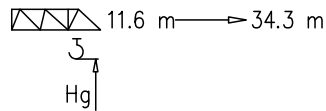

4	B0120	2/2
3	B0060	2/2
2	ST030	2/2
1	ST060	2/2

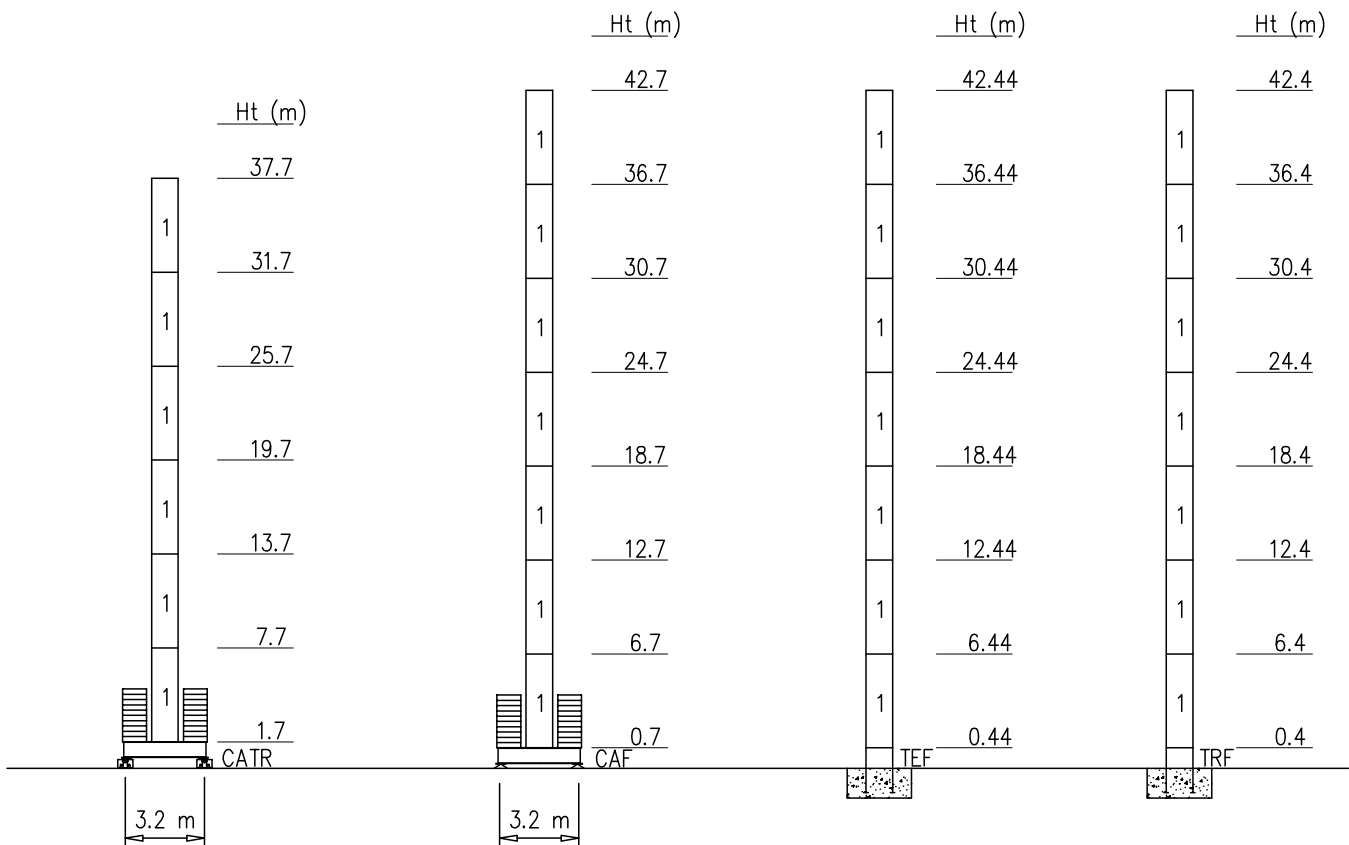

Peso zavorra – Ballast weight – Poids du lest – Ballastgewicht – Peso de lastre

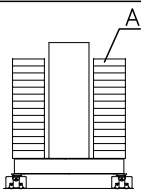

SH1210	
H-CATR (m)	37.7
FEM (t)	54
n°	18xA

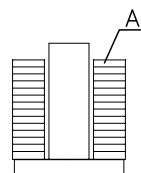
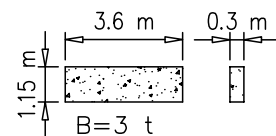

SH1210					
H-CAF32 (m)	18.7	30.7	36.7	42.7	
FEM (t)	18	30	54	78	
n°	6xB	10xB	18xB	26xB	



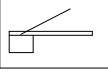
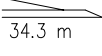
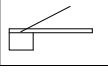
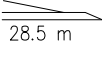
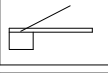
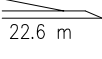
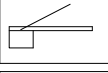
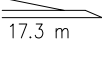
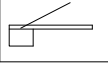
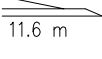

Curve di carico – Courbes de charges – Load diagrams – LastKurven – Curvas de cargas

Pmax 2400 kg

	5460 kg	 34.3 m	2	15.5	19.0	22.6	28.5	34.3	m
			<b>2400</b>	2400	1800	1500	1200	1000	kg
	4380 kg	 28.5 m	2	17.3	21.0	22.6	28.5	m	
			<b>2400</b>	2400	1800	1680	1350	kg	
	3810 kg	 22.6 m	2	19.0	22.6	m			
			<b>2400</b>	2400	1800	kg			
	2730 kg	 17.3 m	2	17.3	m				
			<b>2400</b>	2400	kg				
	1650 kg	 11.6 m	2	11.6	m				
			<b>2400</b>	2400	kg				

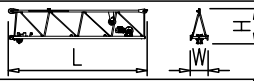
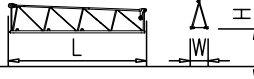
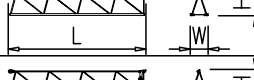
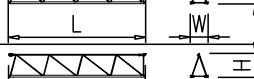
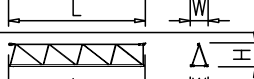
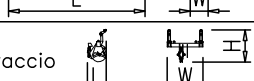

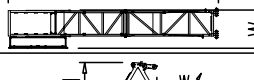
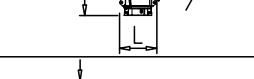
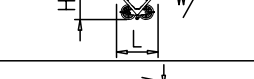
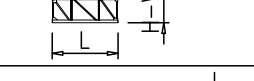
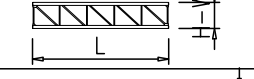
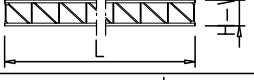
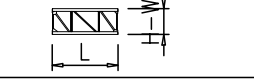
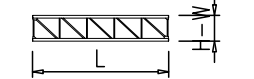
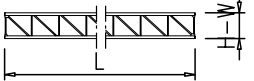
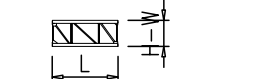
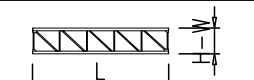
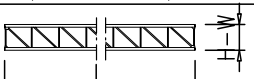
PESI E INGOMBRI – PACKING LIST – LISTE DE COLISAGE – GEWICHT UND ABMESSUNGEN

Denominazione Description	Disegno Draw	Pezzi Pieces	Dimensioni-Dimensions (mm)			Peso-Weight (kg)		
			L	W	H	Unit	Total	
Elemento di braccio Jib element Elément de èche Elemento de flecha	n°6 	1	5910	800	1500	800	–	
	n°5 	1	5890	760	1260	460	–	
	n°4 	1	5870	760	1050	390	–	
	n°3 	1	5850	760	1040	285	–	
	n°2 	1	5830	760	1020	205	–	
	n°1 	1	5820	760	1020	180	–	
	Punta braccio 	1	410	760	690	45	–	
Contorbraccio completo Complete counterjib Contreflèche complète Contraflecha completa		1	9000	1650	1230	1600	–	
Gruppo girevole Slewing group Table tournante Grupo giratorio		SF1100	1	1600	1350	1830	1900	–
		SH1210	1	1600	1350	1830	2000	–
Carrello Trolley Chariot Carretilla		1	880	980	650	75	–	
Elemento di torre Mast element Elément de mature Elemento de torre	ST028 	SF1100	–	2800	1100	1100	550	–
	ST030 	SH1210	–	3000	1210	1210	840	–
	ST058 	SF1100	–	5800	1100	1100	1010	–
	ST060 	SH1210	–	6000	1210	1210	1490	–
	ST116 	SF1100	–	11600	1100	1100	1900	–
	ST120 	SH1210	–	12000	1210	1210	3000	–
	B0028 	SF1100	–	2800	1100	1100	600	–
	B0030 	SH1210	–	3000	1210	1210	900	–
	B0058 	SF1100	–	5800	1100	1100	1260	–
	B0060 	SH1210	–	6000	1210	1210	2120	–
	B0116 	SF1100	–	11600	1100	1100	2370	–
	B0120	SH1210	–	12000	1210	1210	3500	–
	BA028	SF1100	–	2800	1100	1100	555	–
	BA030	SH1210	–	3000	1210	1210	870	–
BA058	SF1100	–	5800	1100	1100	1020	–	
BA060	SH1210	–	–	–	–	–	–	
BA116	SF1100	–	11600	1100	1100	2030	–	
BA120	SH1210	–	–	–	–	–	–	

PESI E INGOMBRI – PACKING LIST – LISTE DE COLISAGE – GEWICHT UND ABMESSUNGEN

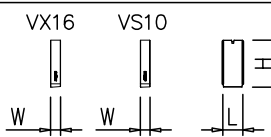
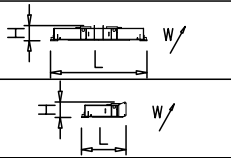
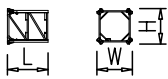
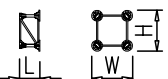
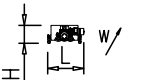
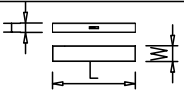
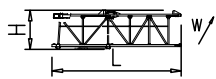
Denominazione Description	Disegno Draw	Pezzi Pieces	Dimensioni-Dimensions (mm)			Peso-Weight (kg)		
			L	W	H	Unit	Total	
Blocchi contrappeso Counterweight block Contre-poids Bloques de contrapeso		VS10	2	850	420	1300	1080	2160
		VX16	2	850	420	2000	1650	3300
Carro di base Base carriage Chassis de base Cruceta de base		2.8x2.8	1	4100	520	660	1050	1050
		3.2x3.2	1	4670	520	660	1160	1160
		2.8x2.8	2	1900	340	660	480	960
		3.2x3.2	2	2180	340	660	550	1100
Elemento a perdere Disposable frame Chassis a perdre Bastidor desechable		SF1100	1	2315	1100	1100	410	–
		SH1210	1	1990	1210	1210	540	–
Elemento recuperabile Recoverable frame Chassis r�cup�rable Bastidor recuperable		SF1100	1	440	1600	1600	630	–
		SH1210	1	440	1700	1700	660	–
Bogie di traslazione Driven bogie Boggie motoris�e Balanc�n de traslaci�n		4	1160	700	600	700	2800	
Blocco zavorra di base Base ballast block Lest de base Bloque de lastre		2.8x2.8	–	3200	1000	300	2200	–
		3.2x3.2	–	3600	1150	300	3000	–
Corsoio di montaggio Climbing cage Cage de montage Jaula de montaje		1	8300	1600	1500	3000	–	

GRU IN CAVEDIO – TELESCOPAGE SUR DALLES – CLIMBING CRANE – KLETTERKRANE IM GEBAUDE

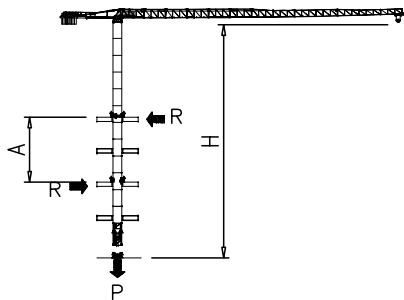

SH1210	H (m)	A (m)
	30.0	Min 9
Apertura passaggio gru Opening for crane passing 		Max 12

SOPRALZO IDRAULICO – TELESCOPABLE – EXTERNAL CLIMBING – KLETTERKRANE

FEM

	SH1210	SF1100
MAX C	27 m	
B	17 m	
A	19 m	

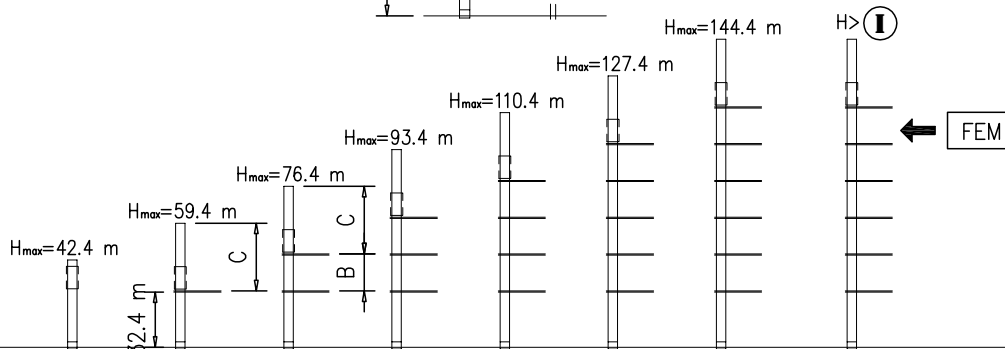
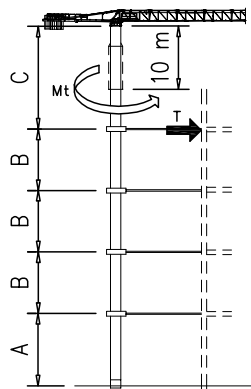

Montaggio – Montage – Erection – Montage – Montaje – Montagem

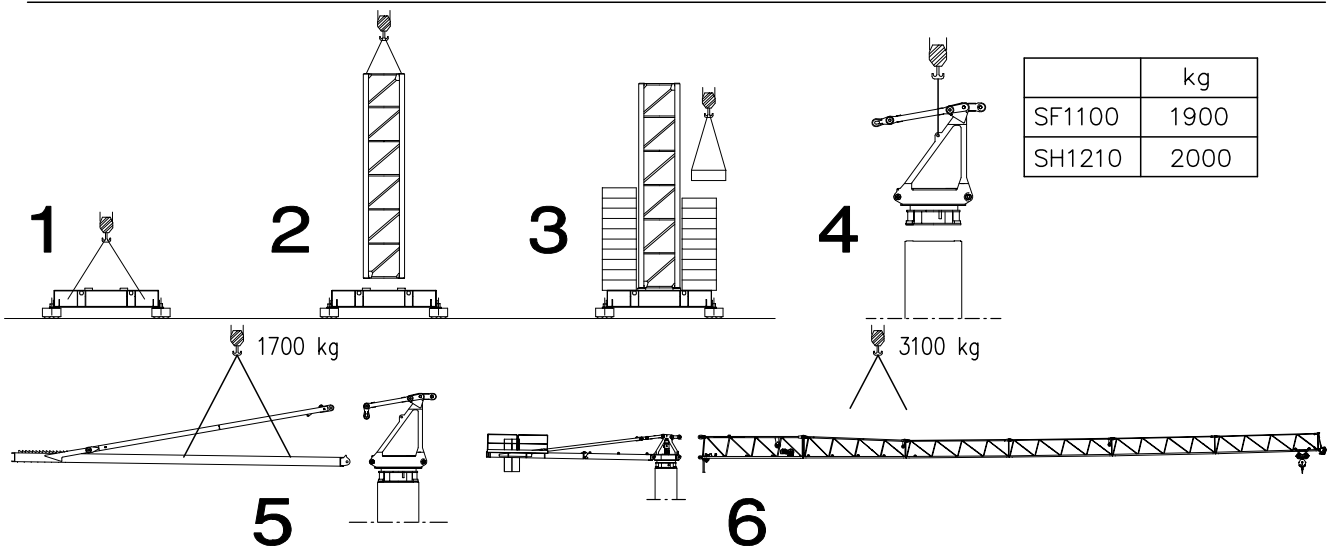

	kg
SF1100	1900
SH1210	2000

1

2

3

4

5

6

1700 kg

3100 kg

Meccanismi – Mechanisms – Mécanismes – Antriebe – Mecanismos

Sollevamento M07.47 Hoisting Levage Heben Elevaciòn Elevaçao							M07.47 7.5 kW 18 kVA  110 m
	m/min	3	16	36	40	47	
	t	2.4	2.4	1	0.8	0.4	

Carrello Trolleying Distribution Katzfahren Distribuciòn Distribuiçao			0 → 70	m/min	1.1 kW	Potenza elettrica necessaria Puissance électrique nécessaire Necessary electric power Anschlusswert – Potencia
Rotazione Slewing Orientation Schwenken Orientaciòn Rotaçao			0 → 0,7	giri/min tr/min rp/min	4 kW	
Traslazione Travelling Translation Kranfahren Traslaciòn Traslaçao			0 → 18	m/min	3.7 kW	

Rete elettrica – Réseau – Mains supply – Netzstrom – Red – Rede electrica	400V – 50 Hz
	480V – 60 Hz

FEM 1.001 – A4 EN 14439 – C25 – D25	
--	--